

file copy

Cornell University
College of Agriculture and Life Sciences

Animal Science Mimeograph Series 188
ABEN Staff Report No. 96-1

ARME Research Bulletin 96-07
SCAS Research Series 96-4

**Integrating Knowledge to Improve
Dairy Farm Sustainability**



Dairy Farm Sustainability Project
Final Report
June 1996

Acknowledgments

The Dairy Farm Sustainability Project Team wishes to express their sincere appreciation and thanks to the farm owners and managers of the two participating case study farms. To maintain the confidentiality of information provided in this report, these individuals will remain unnamed but we appreciate their help and time nevertheless.

The activities on which this report is based were funded by:
The Agricultural Experiment Station of the Cornell University College
of Agriculture and Life Sciences;
The Agricultural Ecosystems Program and
U.S. Geological Survey, New York State Water Resources Institute.

New York State College of Agriculture and Life Sciences, Cornell University provides equal program and employment opportunities.

**Integrating Knowledge to Improve
Dairy Farm Sustainability**

**Dairy Farm Sustainability Project
Final Report**

June 1996

Integrating Knowledge to Improve Dairy Farm Sustainability

Table of Contents

	<u>Page</u>
Executive Summary.....	1
Part I: Objectives, Procedures, and Lessons Learned	
D.G. Fox, C.N. Rasmussen, R.E. Pitt and J.J. Hanchar	7
Part II: Plant and Animal Nutrient Management	
S.D. Klausner, D.G. Fox, T.P. Tylutki, W. Stone, L. Chase and R.E. Pitt	23
Part III: Environmental Losses and Nutrient Flows	
J.L. Hutson, R.K. Koelsch, R.E. Pitt, and R.J. Wagenet.	47
Part IV: Economic Evaluation of Alternatives to Improve Nutrient Efficiency	
C.N. Rasmussen, J.J. Hanchar and P.E. Wright.....	71
Part V: Manure Management	
R.K. Koelsch.....	89
Part VI: Measuring Nutrient Loads from a Drainage Basin Within the Farm Boundaries	
J.B. Houser, R.E. Pitt, J.L. Hutson and P.E. Wright	105
Part VII: Farm A Environmental Assessment	
K.J. White and P.E. Wright	118
Part VIII: Pathogen Prevalence and Management	
S.E. Wade.....	143
Part IX: Dairy Farmers in Cayuga County, New York: World View	
P.M. Crosscombe and D.M. Ewert.....	149
Part X: Computerized Decision Aid Tools	
D.G. Fox, S.D. Klausner, M.C. Barry, R.E. Pitt, J.J. Hanchar and C.N. Rasmussen.....	159
Dairy Farm Sustainability Project Publications.....	165

Integrating Knowledge to Improve Dairy Farm Sustainability: Executive Summary

Dairy farms' cash sales of milk and meat account for approximately 59 percent of all New York State's agricultural receipts. Keeping our dairy farms sustainable is critical to the economy of the state. Maintaining economic viability while insuring environmental quality is key to the sustainability of the dairy industry. Sustainability of New York State dairy farms can be improved through the more effective use of existing knowledge in creating comprehensive resource management plans for each farm. The ability to develop such plans is limited more by the failure to integrate existing information than by the lack of knowledge.

A group of Cornell faculty, staff, students, extension agents and farmers has been working together to develop a process for integrating the knowledge necessary to improve dairy farm sustainability (Part I, Table 3.). Working with two case study farms, the Dairy Farm Sustainability Project (DFS) has studied a variety of farm conditions and practices associated with environmental issues. Sophisticated models were used in innovative ways to evaluate environmental conditions on the farms and prescribe recommendations. This report presents the procedures, results and discussion of this effort in a series of ten articles.

PROJECT OBJECTIVES

Use a case study approach to:

1. Evaluate the status of the whole farm and each component within the farm, using existing tools, to determine whether nutrient loss or excess is contributing to water pollution.
2. Develop, with each dairy farmer, nutrient management plans for cows, crops and soils to minimize nutrient losses or excesses.
3. Evaluate the environmental and economic impact of the plan on the whole farm system.
4. Develop, implement and document a system for evaluating the impact of alternative management practices.
5. Develop tools to facilitate the whole farm planning process.
6. Build a partnership through which farmers, extension staff, students, and university faculty engage in research and extension to improve farm sustainability.

PROJECT RESULTS

Identification of Case Study Farms

Two large Central New York State dairy farms participated in the project as case study farms. These farms are referred to as "Farm A" and "Farm B". Because of the farm owners' proactive attitude concerning their environmental responsibilities, they volunteered their farms to be used as research sites.

Ration Evaluation

The Cornell Net Carbohydrate and Protein System (CNCPS) was used to evaluate cattle nutrient utilization. The CNCPS model was developed to integrate information on animal breed and mature size, thermal environment, feed composition and intake, and digestion and passage rates to predict animal performance, feed energy values, site of digestion and use of dietary protein, and ruminal microbial growth efficiency. Farm specific inputs were used in the model, and the extent to which microbial nutrient requirements and animal energy and protein requirements were deficient or in excess was determined.

The rations were analyzed and reformulated with the objective of reducing imported and excreted N while keeping milk production at current levels. As a result of adoption of the reformulated rations on farm A, excretion of total N, organic N, and ammoniacal N decreased by 34, 15 and 50 %, respectively, over the test period. These reductions result from both reduced intake of N and more efficient utilization of N. Similar reductions in excretion of P and K occurred.

Mass Nutrient Balances

For each farm a mass nutrient balance for N, P and K was constructed. Complete soil and crop analyses were completed. Imports and exports of feed, fertilizers, animals, meat and milk were determined using farm records. Nitrogen fixation was estimated from legume acreage.

In the one year study period, Farm A had a difference between N imports and exports of 51 tons, which is 72% of the imports. Thus, 72% of the imported N was retained on the farm or volatilized. Mass balances for P and K also showed that imports exceeded exports, with net excess rates of 59 and 71%, respectively. Net excess rates of N, P, and K as a percentage of imports were comparable for N but higher for P and K on Farm B (N=76%,P=75%,K=85%). For both farms, purchased feeds accounted for the largest share of imported nutrients. Nutrients in manure exceeded crop requirements. N fixation by alfalfa, in addition to high soil test levels of P and K as a result of previous overapplications of fertilizer and manure, reduced the need for supplemental nutrients.

Matching feed and fertilizer purchases to actual need will help reduce nutrient imbalances and prevent excessive nutrient loss. To achieve this a nutrient management plan (NMP) was developed for each farm which considers (a) the movement and quantity of nutrients entering, leaving and remaining on the farm, (b) the nutrient requirements of the crop rotation, and (c) the distribution of nutrients to meet the crop requirements. Recommendations for fertilizer and manure application were made for each field considering the total amount of manure produced, the crop rotation, soil type, risk level and net nutrient requirements.

Environmental Losses of N from the Fields

A nitrogen simulation model (LEACHN) was used to address the implications of various cropping and manure application patterns on the groundwater. LEACHN models N transformations, volatilization, denitrification, and leaching from soils. The modeled losses of N to the environment are volatilization from manure storage, leaching, and volatilization and denitrification from the fields. The sum of these losses was 78,800 and 120,960 lb. N/year respectively for Farms A and B. This represents over 75% and 67% of the retained N in the whole farm N balance for 1994. Thus, most of the N net excess could be ascribed to

environmental losses. In terms of groundwater quality, leached N represented about 10% of the retained N on both farms.

Current water quality standards call for nitrate-N concentrations in the groundwater not to exceed 10 ppm. Average N concentration of the leachate was predicted to be very close to 10 ppm for all fields combined on Farm A and about 14 ppm for all fields combined on Farm B. Generally, groundwater and leachate concentrations are not equal, and significant dilution of the leachate is likely to occur when it reaches the groundwater. Leaching was much greater from the better drained soils. On Farm A, about 70% of the leached N occurred on 25% of the land area. The N leached per area was more closely related to soil drainage class than to land use (crop).

Manure Management

Characteristics and quantities of manure were determined by multiple data collection visits to each farm. Manure was analyzed for total N, ammonia N, organic N, urea, P, K, pH and total solids. Manure leaving storage had a low solids content (4.3 to 6.0% solids). It was calculated that forty to fifty percent of the manure volume handled represents water added from the milking center, precipitation water and added water for purpose of producing a more pumpable slurry. Application of the extra water increases farm machinery and labor costs. Practices which would decrease excess water in the manure include: capturing and reusing milking center waste water, maintenance of roof gutters, and solids separation. However, increasing the solids content of the manure could require use of a pump capable of handling a slurry with greater than 10% solids.

N volatilization losses from both farms are estimated to be 12 to 17% of total Kjeldahl nitrogen (TKN) produced by the cows and replacement herd. Atmospheric losses of N can be viewed in a positive or negative light. On the positive side, less land area is required if rates of manure application are N based and there is less chance of N loss to water if a greater proportion is volatilized. On the negative side, higher application rates of manure could result in greater accumulation or environmental loss of P and a greater concentration of K in the crops, potentially leading to K toxicity. Atmospheric losses of N may also contribute to air quality problems, and the resulting impact on neighbor relations has numerous implications. Viewing atmospheric loss of N as a detriment implies that the N should be conserved in storage, handling, and application, and suggests a host of possible management changes including entrainment of manure into the soil.

Economic Evaluation of Nutrient Management Alternatives

A series of partial budgets were used to evaluate the economic impact of implementing the proposed nutrient management plans on the case study farms. On farm B implementation of the NMP had a positive impact, increasing the return to operator, labor and management, \$16,001. This is due to savings on the purchase and use of commercial fertilizers. On Farm A, the increase in milk production and decrease in feed expenses resulted in a projected increase in net farm income of \$42,000 during the first year. The projected benefit of the NMP on Farm A's profitability was positive but small (\$1,350) compared to the farm's revenues and expenses. Constructing a remote manure storage pond increased net profits by \$7,300 if existing labor were used for spreading but was reduced to \$3,200 if manure was custom applied.

The sensitivity to possible changes in productivity as a result of implementing alternatives could be critical to farm profitability. On the case study farms, the expected impact of the proposed alternatives were small compared to the potential impact changes in milk or crop

production would have. For example, a yield decrease of about 1 and 3.5 % of all crops produced on farms A and B respectively would have eliminated any benefit of the NMP.

Water Quality On-Farm Assessment

A water monitoring program was conducted on Farm A in which actual leaching and runoff of nutrients was measured by identifying and delineating an area drained by a single stream (i.e. a drainage basin) and monitoring the concentrations of nitrate-nitrite-N ($\text{NO}_4\text{-NO}_2\text{-N}_3$), phosphorus (P) and total solids in the stream. A sampling site, draining an area of 25 to 40 acres, was selected to allow estimation of nutrient movement through and over the soil, and the impact of such movement on water quality. A V-notch weir with a mechanical float streamflow monitor provided by the USGS is being used to measure streamflow. An ISCO sampler is taking continuous composite samples of water from the stream every 90 minutes to be analyzed for phosphorous and nitrogen content.

Though there is not enough data to estimate the yearly loading or average concentration of the measured nutrients the data shows that at certain times during the year nutrient concentrations leaving the farm in streamflow may be significant. In October, the average concentrations were 18.8 and 0.52 ppm for $\text{NO}_4\text{-NO}_2\text{-N}_3$ and total P, respectively. In November, the average concentrations were 113.4 and 0.38 for $\text{NO}_4\text{-NO}_2\text{-N}_3$ and total P, respectively. The $\text{NO}_4\text{-NO}_2\text{-N}_3$ amounts are close to the EPA standards of 10.00 ppm. However, total P is much higher than the 0.1 ppm pollution standard but within the usual range of concentrations in agricultural fields (0.05 to 1.1 ppm). How this data can be related to the entire farm and to the off-farm environment needs to be investigated further.

Comprehensive Environmental Assessment

Five farm environmental assessment tools were evaluated on their ability to identify and rectify potential farm environmental problem areas in a user friendly manner. The Ontario Environmental Farm Plan (OEFPP) was chosen for further study on case study Farm A because it was comprehensive and easy to use. Subsequent potential problem areas on this farm as identified by the OEFPP are prioritized and possible solutions suggested. Preliminary plans were developed for the four problem areas with the highest priority: silage storage, manure storage, milk center washwater recycling and barnyard runoff.

Pathogen Prevalence

Since agricultural animals are potential sources of *Giardia* and *Cryptosporidium parvum* (C. parvum), accurate prevalence data are necessary. For calves less than six months old, 70% of the calves were sampled. For calves six months old to first freshening samples were collected from at least six animals. Older than first freshening, samples were collected from at least nine animals. Laboratory examination of the fecal samples collected was carried out using a quantitative centrifugation flotation technique and the antigen capture enzyme linked immunosorbent assay (ELISA) test.

Giardia was present in the feces of 19% of the calves sampled on Farm A and in 18% of the calves in Farm B. *C. parvum* was found in the feces of 19% of calves sampled on Farm A and 16% on Farm B. Guidelines were developed for each farm to control the prevalence and movement of these pathogens.

Worldview Study of Dairy Farmers

A qualitative, interpretivist study based on interviews with 34 Cayuga County Farmers was conducted to examine farmers' perceptions about the environment, change and the future. Main questions asked included (1) To what extent do farmers perceive an environmental crisis. (2) How do farmers view the future? (3) How do farmers make management changes on their farms?

One of the main fears of the future cited by farmers was the increasing influence that the non-farm sector has in the development of farm regulation. One of the main fears of the future cited by farmers was the increasing influence that the non-farm sector has in the development of farm regulation. Most farmers who adopted new management practices were motivated more by economic than environmental considerations. Many farms feel that they are being left out of discussions regarding environmental issues and are being defined as causing environmental problems by people who do not understand the context. This study will help agricultural scientists understand how farmers perceive the environment and make management decisions.

Future Development of Computerized Decision Aid Tools

This project identified the need for a family of integrated computerized decision aid tools to simplify and enhance the task of integrating knowledge to improve nutrient management and farm profitability. The development of this "tool-box" is a continuing extension of this project. We are currently:

1. developing simplified, user-friendly tools to assess nutrient management on dairy farms;
2. integrating information on crop production and rotation, soil fertility, animal nutrition, and economic and engineering considerations in assessing farm nutrient management;
3. providing information flow from the farm records into the decision aid tools by identifying the on-farm data which needs to be collected and developing the necessary on-farm record keeping systems; and
4. verifying the usefulness of these tools in farm assessments.

Existing models to predict environmental losses of nutrients to groundwater and surface waters will be simplified for use in the data integration processes. This effort will assist in the application of computerized whole farm planning to large numbers of New York State farms.

CONCLUSIONS

1. Excess farm nutrients are a potential environmental hazard. Nitrates in drinking water can harm animals and humans, phosphorus run-off contributes to eutrophication of water bodies and elevated K levels in the soils and consequently feedstuffs may negatively affect animal productivity. The major proportion of nutrients N, P and K imported and N resulting from nitrogen fixation by legumes were subject to environmental loss from the farms.
2. A model (LEACHN) predicted that the N in the leachate was at or above the current water quality standard for groundwater. It is assumed that dilution will take place when the leachate mixes with the groundwater. However, the model used a best management scenario, when calculating the N leached. The model predicted that soil type was more critical to the amount of N leached than the crop. This is useful for identifying the hydrologically sensitive areas on the farm.
3. A comprehensive environmental assessment was useful for identifying and prioritizing potential environmental problems. Recommendations were made to control nutrient loading and other possible environmental problems.
4. Using the CNCPS for more accurate ration formulation was successful in decreasing the amount of N imported to the farm and excreted by the cows while increasing milk production and decreasing feed costs.
5. A Nutrient Management Plan (NMP) was developed for each farm which specified manure and fertilizer application rates. Use of these plans would decrease nutrient net excess on the case study farms, especially P and K. However, it must be recognized these recommendations are by design minimizing nutrients provided to the animals and fields for a given performance level. Because “insurance factors” are being decreased, successful use of these recommendations depends on excellent management and the expertise necessary to use sophisticated tools such as the CNCPS.
6. Specific recommendations were also made concerning manure storage, handling and application, calf raising practices, waste water recycling, silage leachate control, and barn yard runoff.
7. On these two farms the economic impact of implementing the primary recommendations, the animal and agronomic nutrient management, had a positive influence on net farm income. On one farm, farm income was increased due to ration changes resulting in an increase in milk production and a decrease in feed costs. On the other farm, implementation of the agronomic portion of the NMP was predicted to increase net farm income by decreasing fertilizer costs. These results are specific to the resources and management practices on these farm. The economic impact of nutrient management and other environmental remedies would be highly variable from farm to farm.
8. Maintaining economic viability while insuring environmental quality is key to the sustainability of the New York State dairy industry. To do this, farmers will need to adopt innovative resource management practices. It will require a continued interdisciplinary effort to develop and evaluate tools needed for this task.

Integrating Knowledge to Improve Dairy Farm Sustainability - Part I:

Objectives, Procedures, and Lessons Learned

D.G. Fox, C.N. Rasmussen, R.E. Pitt, and J.J. Hanchar

ABSTRACT

The agricultural research, extension, and education community is being asked to join with the nation's farmers to transform modern agriculture to a system that is more environmentally, economically, and socially sustainable. Agricultural sustainability depends on preventing environmental degradation due to agricultural production while meeting the financial and personal goals of the farm owners. Farm sustainability can be improved by developing resource and nutrient management plans which meet environmental and farm business goals. The ability to develop such plans is limited more by the failure to integrate existing knowledge than by the lack of research information. In this article, we review literature on sustainable agriculture, knowledge integration, and systems analysis, and describe the objectives, uniqueness, and outcomes of the study. In the succeeding articles, we describe the development of recommendations for animal and plant nutrient management, estimation of nutrient losses to the environment, and projected costs and benefits of implementing recommended changes in farm practices. Positive and negative aspects of multidisciplinary work and the case study approach are discussed in this article. We conclude that conducting multidisciplinary research requires a process that clarifies the objectives and identifies ways to attain goals in an organized fashion.

INTRODUCTION

Dairy farms' sales of milk and meat account for 59% of all of New York State's agricultural receipts (New York Agricultural Statistics Service, 1995). Maintaining economic viability of the dairy industry while ensuring environmental quality is critical to the economy of the state and is key to the sustainability of the industry. Environmental concerns include degradation of surface and groundwater quality by accumulation of N, P, sediments, toxins (pesticides, petroleum, and other industrial chemicals), and pathogens (protozoa, bacteria, viruses) (Stockle et al., 1994). Contamination of drinking water from non-point source pollution has been identified by federal and state regulatory agencies as a particular concern (Davenport, 1994).

This study was stimulated by a group of dairy producers who were motivated by a proactive attitude concerning the environment. A group of farmers, extension staff, and scientists at Cornell was formed to look at a broad range of environmental issues on dairy farms. In this report, we document that process.

Nutrient loading and its effect on water quality are complex issues. Integration of knowledge across disciplines, including soil science, crop science, animal science, engineering, and business management, is necessary to create comprehensive animal and agronomic resource management plans that increase nutrient use efficiency and limit nutrient losses (Hildebrand, 1990). The ability to develop such plans is limited more by the failure to integrate existing knowledge than by the lack of information available to farmers and scientists.

In this article, we review some of the literature on sustainable agriculture, knowledge integration, and systems analysis, and describe the objectives, uniqueness and outcomes of this study. In the succeeding nine parts, we describe the specific work on enhancing the sustainability of these case study farms and other dairy farms. Because the study of sustainable agriculture is a relatively new research area, the associated terminology is still evolving. Therefore, three key terms, “sustainable agriculture,” “knowledge integration,” and “planning process,” are briefly reviewed in the context used in this work and elsewhere.

Sustainable Agriculture

The definition of “sustainable agriculture” has been a controversial topic and the source of a great deal of discussion (Alatieri, 1989; Dicks, 1992; Dunlap et al., 1992; Francis, 1995; Fretz et al., 1993; Lanyon and Meij, 1992; MacRae et al., 1989; Neher, 1992; Stockle et al., 1994). The basis of the controversy is the linkage -- actual or perceived -- between the terms “sustainable agriculture” and “alternative agriculture.” Sustainable agriculture has been used to describe “everything from organic farming to maximum economic yields” (Dunlap et al., 1992). Despite these differences, most definitions of sustainable agriculture are predicated on three components: soil productivity, environmental soundness, and socioeconomic viability (Neher, 1992; Fretz et al., 1993); in some definitions, the social and economic components are separated.

Stockle et al. (1994) defined sustainable agriculture as a process that results in an array of farming practices tailored to site-specific conditions. Thus, rather than attempt to design a single set of best management practices universally applicable to all farms, we set out to develop a process to allocate resources on specific farms in a way that meets the objectives of agricultural sustainability.

Knowledge Integration and Multidisciplinary Research

An enormous amount of data on biological responses to many factors has accumulated in scientific journals. The application of this research to farming, however, continues to be an expensive trial-and-error process (Stevenson et al., 1994). For example, methods of designing animal rations to support higher levels of milk production are widely studied, but the associated effects on land use and the cropping system are not. What is still problematic is a process to identify the impact of changing variables in one part of the farm on the whole farm system, as well as the interactions among several such variables (Bawden, 1991; Lanyon, 1992).

Knowledge integration is a process that can link research on plant and animal requirements and responses to various soil, crop, animal, environmental, and management conditions. In this regard, the need for a multidisciplinary approach in sustainable agriculture has been well documented (Neher, 1992); research in this area should involve natural, agricultural and social scientists who have a commitment to multidisciplinary inquiry (National Research Council, 1991). In some studies the scientific questions associated with agricultural sustainability have been considered too complex for single-discipline research (Alatieri, 1989; Fretz et al., 1993; Hildebrand, 1990; Temple et al., 1994).

A systems approach to research is used in many disciplines, although the terminology has varied (Weiss and Robb, 1988). Oberle and Keeney (1991) defined systems research as “the integration of information about, and subsequent evaluation of, the complex, interrelated whole (system).” The linkage between systems research and sustainable agriculture has been well established (Bawden, 1991; Dlott et al., 1994; Fretz et al., 1993; Luna et al., 1994; MacRae et al., 1989; Oberle and Keeney, 1991; Stevenson et al., 1994). The National Research Council (1991) has identified the lack of systems research as an obstacle in the development of a more sustainable agriculture.

The benefits of farmer involvement in sustainable agriculture research have also been noted (Dlott et al., 1994; MacRae et al., 1989; Murray et al., 1994b; Stevenson et al., 1994; Temple et al., 1994). Using farmer input in the design of sustainable agriculture research is thought to raise the quality and relevance of the knowledge generated (Stevenson et al., 1994). However, few studies which use a multidisciplinary approach have also attempted to use commercial farms. Multidisciplinary studies of sustainable farming systems have focused on experiment stations, in which comparisons were made between conventional and low-input or organic systems (Peters et al., 1988; Smolik and Dobbs, 1991; Temple et al., 1994). Research which did use case study farms focused on specific management practices that contribute to sustainability of one part of the farm system (Murray et al., 1994a).

Crop production has been the main subject of sustainable agriculture research (Dlott et al., 1994; Murray et al., 1994a; Smolik and Dobbs, 1991; Temple et al., 1994). Studies explicitly considering the role of livestock in sustainable agriculture have focused on grazing and alternative pasture systems (Dsouza et al., 1990; Murphy, 1990). Luna et al. (1994) compared conventional and alternative crop-livestock farming systems on an experiment-station farm. The crop mix, rotation plan, and the grazing intensity of beef steers on pasture and the rations of the steers in the finishing phase were varied between the two systems.

Simulation or other modeling techniques such as linear programming have been an important part of sustainable agriculture research (Coote et al., 1975; Domanico et al., 1986; Lemberg et al., 1992; Rotz et al., 1989; Schmit and Knoblauch, 1994; Westphal et al., 1989; Johnson et al., 1991). The main focus in several studies was determining the optimal farming system for a given set of resource or public policy constraints.

A body of work from the Pennsylvania State University measured nutrient flows on commercial case study farms (Bacon et al., 1990), developed a process of organizing farm nutrient data to formulate an agronomic nutrient management plan (Lanyon and Meij, 1992; Lanyon and Beegle, 1989), and analyzed the costs and benefits of farm nutrient information (Lemberg et al., 1992).

OBJECTIVES

1. Develop a process to evaluate the nutrient status of a commercial dairy farm and each component within the farm, and estimate the extent to which nutrient loss or excess is contributing to water pollution.
2. Develop, with the participating farmers, nutrient management plans for animals, manure, crops, and soils to minimize nutrient losses or excesses.
3. Develop a process to evaluate the environmental and economic impacts of alternative management practices on the whole-farm system.

PROCEDURES

Two large New York dairy farms (Farms A and B) participated in the project for approximately one study year (1994). Both farms were progressive industry leaders with above-average management. The basic method was to collect data from the farm that could feasibly be measured, and to use simulation and modeling when necessary for the analysis of processes that could not be measured.

Oberle and Keene (1991) and Karlen et al. (1994) defined a planning process as a sequence of steps to identify objectives, define and diagnose problems, generate alternative solutions, select the best alternatives based on established criteria, and develop an implementation plan. Although the project group did not consciously follow a formalized process for developing and implementing resource management plans, our desire to use the current farm structure as a starting point, and the need to follow a course of action which would be acceptable to the farmers led us to follow many of the steps in a planning process. In reality, the chronology of the research was not an exact step-by-step process (see Discussion). Detailed procedures are described in each of the nine parts following.

Situation Analysis

The first step was to inventory the current farm business and resource situation. Table 1 summarizes data collected and variables accounted for on the case study farms during the study period. Table 2 provides an overview of selected farm data.

Nutrients concentrate on livestock farms if more nutrients are imported as feeds, fertilizer, and nitrogen fixation than are exported as products sold (Klausner, 1993). Mass nutrient flows for N, P, and K were estimated on the two farms. Complete soil and crop analyses were performed. Imports and exports of feeds, fertilizers, animals, meat, and milk were determined from farm records. Nitrogen fixation was estimated from legume acreage. A simple crop-soil-animal nutrient balance was also calculated, comparing the amount of N, P, and K excreted in manure with the amount required for crop production. For this, a manure assessment was conducted with analysis for total N, ammonia N, organic N, urea, P, K, pH, and total solids. Manure production was estimated by several methods.

Problem Diagnosis

Losses of N to the environment were estimated due to volatilization from manure storage, leaching from soils, and volatilization and denitrification from the fields. A soil-nitrogen simulation model (Hutson and Wagenet, 1991, 1992) was used to estimate N transformations, volatilization, denitrification, and leaching. Accumulation or depletion of N, P, and K within different subcomponents of the farm was estimated.

Table 1. Inputs and data sources for various procedures in nutrient management.

Procedure	Variables and Inputs Needed	Data Source
Mass nutrient balance	Imports of N,P,K in feed, fertilizer, livestock, and legume N fixation Exports of N,P,K in milk, meat, calves and crops sold	Farm accounting records
Manure composition and flows	Manure processing, handling & storage	Farm records, manure nutrient analysis
Nitrogen leaching	Soil properties and initial conditions Condition of soil surface due to rainfall, temperature, evaporation, nutrient additions Cropping pattern	Background modeling, soil tests/regression Aurora Experiment Station records Farm records, literature, estimates
Ration formulation	Feed requirements, manure N, P, K Milk urea-N, energy balance Ration options Nitrogen status and reproduction	Farm records, feed analysis, DHIA records
Nutrient management plan	Quantity of manure nutrients Fertilizer requirements and soil N,P,K Crop uptake (corn, alfalfa, other) Crop rotation	Farm records, manure analysis Manure analysis, farm records, soil tests Crop analysis/yields Farm records, cattle requirements
Nutrient flows	Animal inventories, rations, crop production Mass nutrient balances, N leaching, volatilization, denitrification, N fixation	Farm records, mass balance calculations, LEACHN model
Partial budget analysis	Input/output prices, rations, crop yields, manure application rate and distribution, labor, capital inputs, machinery data	Farm records, literature

Table 2. Selected farm business characteristics of case study Farms A and B.

Item	Farm A	Farm B
Farm Size		
Number of cows, milking and dry (12/31/94)	320	525
Number of heifers (12/31/94)	290	490
Crop land (acres)	604	1,078
Productivity		
Rolling herd average (lb/head)	26,000	24,000
Corn silage yield (tons dry matter/acre)	5.9	5.9
Alfalfa haylage yield (tons dry matter/acre)	5.8	4.4
Annual Manure Production		
Liquid (thousand gallons)	2,562	5,352
Non-liquid (tons)	652	2,664

Alternatives to Current Practices

Specific management changes were recommended that entailed both animal and crop/soil nutrient management planning. Details of these alternatives and a description of the systems and tools used to formulate recommendations are given in Part II (Klausner et al).

Ration reformulation. Animal rations were analyzed with the objective of reducing imported and excreted N while maintaining milk production at current levels. The Cornell Net Carbohydrate and Protein System (CNCPS) was used to evaluate cattle nutrient utilization (Fox et al., 1995). Farm specific inputs were used in the model, and the extent to which rumen microbial nutrient requirements and animal energy and protein requirements were deficient or in excess was determined. Over a period of two years, animal rations were reformulated to meet requirements while limiting excess nutrient supply.

Nutrient management planning. A step-by-step process of soil/crop nutrient management planning was formulated for efficient use of manure nutrients with minimal use of commercial fertilizers. Recommendations for fertilizer and manure applications were made for each field considering the total amount of manure produced, the crop rotation, soil type, risk of runoff, and net nutrient requirements.

Comprehensive Environmental Assessment -- The Ontario Environmental Farm Plan was used to identify areas where the potential for an environmental problem exists. Suggested solutions and preliminary plans were developed for the four problem areas with the highest priority: silage storage, manure storage, milk center washwater recycling and barnyard runoff.

Pathogen Prevalence -- Agricultural animals are potential sources of two parasitic protozoa, *Giardia* and *C.parvum*, which are a health concern for humans. Both of these pathogens were found in feces of animals on Farms A and B. Guidelines were developed for each farm to control the prevalence and movement of these pathogens.

Evaluation of Alternatives

Nutrient flows within farm boundaries. The flows of nutrients (N, P, K) were calculated for the whole farm and across subunits of the farm. The rate of accumulation of nutrients for the whole farm during the study year (1994) was compared to the projected accumulation for the next year (1995) assuming implementation of the nutrient management plan. Nutrient flow analysis is described in Part III (Hutson et al).

Economic analyses. The economic costs and benefits as well as the feasibility of the changes in animal and crop nutrient management were determined. Constraints on labor and capital resources were incorporated into the recommendations, and the expected effect on net farm income was estimated using a partial budget approach. These results are described in Part IV (Rasmussen et al.).

DISCUSSION

This work differs from previous research in the following ways:

1. This work explicitly incorporated the role of dairy cattle in the farming system. The process for developing nutrient management plans included both animal nutrient management and agronomic recommendations. Unlike earlier work, this research accounted for the impact of herd management on feeding, animal productivity, crop nutrient management, whole-farm mass nutrient flows, and farm profitability.
2. This study focused on analyzing commercial farms. Other articles called for an integrated analysis of commercial farms; ours is among the first to attempt it. The case study farms in this research were essentially conventional dairy farms, and were alternative only insofar as the farmers were progressive in learning about environmental problems on their farms and what to do about them. Using commercial farms introduced both strengths and weaknesses into the approach.
3. The multidisciplinary makeup of the study group included not only scientists from a broad range of disciplines, but undergraduate and graduate students, extension field staff, and the farmers themselves as participants. A list of participants is given in Table 3 (farmer cooperators are not listed to protect confidentiality).

Integrating Knowledge - Lessons Learned

This group came to use a systems approach because it was the obvious way to integrate the knowledge necessary to accomplish the objectives. Although the group used techniques common to a more formalized planning process (writing a mission statement, listing goals, developing procedures for problem identification, producing alternative solutions, and evaluating alternatives), we did not set out on an orderly planning process by *a priori* decision. If the planning process had been formalized early in the project, it may have saved time and increased our efficiency of data collection and analysis. Perhaps our greatest lesson was that conducting multidisciplinary research requires a planning process that clarifies the objectives and roles and identifies ways to attain goals in an organized fashion.

Table 3. Dairy farm sustainability project contributors, 1993-1995.

Principal Scientists	Title
Danny Fox, Chair	Professor, Animal Science
Larry Chase	Assoc. Professor, Animal Science
Debbie Cherney	Sr. Research Assoc., Animal Science
Jerry Cherney	Professor, Soil, Crop, and Atmos. Sci.
Merrill Ewert	Asst. Professor, Education
John Hutson	Sr. Research Associate, Soil, Crop, and Atmos. Sci.
Stuart Klausner	Sr. Extension Associate, Soil, Crop, and Atmos. Sci.
Wayne Knoblauch	Professor, Ag., Resource, & Managerial Econ.
Rick Koelsch	Asst. Professor, Bio. Systems Engineering, U. of Nebraska
Alice Pell	Assoc. Professor, Animal Science
Ron Pitt	Professor, Ag. & Bio. Engr.
Keith Porter	Director, NYS Water Resources Institute
Susan Wade	Sr. Research Associate, Vet. Diagnostic Lab
Jeff Wagenet	Professor & Chair, Soil, Crop, and Atmos. Sci.
Keith Waldron	Sr. Extension Associate, Int. Pest Mgmt.
Peter Wright	Sr. Extension Associate, Ag. & Bio. Engr.

Staff	Title
Kathy Barrett	Cornell Cooperative Extension Agent
Mike Barry	Nutritionist, Animal Science
John Hanchar	Economist, Ag., Resource, & Managerial Econ.
Cindy Malvicini	Coordinator, Center for the Environment
Caroline Rasmussen	Economist, Animal Science
Stephanie Schaff	Research Associate, Vet. Diagnostic Lab
Tom Tylutki	Nutritionist, Animal Science
Judy Wright	Cornell Cooperative Extension Agent

Students	Area of Study
Pat Crosscombe	World View Study, Education
Jim Houser	Data Synthesis and Modeling, Ag. & Bio. Engr.
Julie Monaco	Manure Sampling and Losses, Ag. & Bio. Engr.
William Stone	Dairy Cattle Nutrition, Animal Science
Kimberly White	Environmental Assessment, Ag. & Bio. Engr.

The study was both multidisciplinary and systems based, attributes which had positive and negative aspects. Over the course of the project, we learned disciplinary subject matter from one another and were presented with new ways of thinking about planning and problem solving. As time progressed, we graduated from having a polite interest in each others' work to having a real stake in understanding each others' results. The interactions among project members also forced us to think about our own disciplines from a new perspective (see Murray et al., 1994a). In the process of working together we developed a rapport with each other and informally developed a structure for conducting multidisciplinary work; this had the added benefit of improving our ability to transfer knowledge to practice. Dividing the leadership duties among project participants was also important in giving everyone a feeling of shared ownership of the project.

On the other hand, the process of integrating knowledge was not simple or obvious. It was agreed by some participants that although group members may be outstanding in their disciplines, our collective understanding of how to integrate knowledge still needs to be advanced. Like other researchers (Lockeretz, 1991; Murray et al., 1994a), we found that multidisciplinary research is difficult and time consuming, and it is hard work to develop a "shared vision" of what needs to be accomplished and the best way to proceed. Luna et al. (1994) pointed out that multidisciplinary research requires a significant time commitment from the participating scientists if they are to feel that they "own" the project. Given the difficult and time-consuming nature of the integration process, a logical next step will be to automate the process of knowledge integration through the development of computerized decision support tools.

Yet another challenge of the multidisciplinary approach was an inequality in the level of aggregation and precision among disciplines. For example, assumptions used in the nutrient flow and economic analyses were much broader and less precise than the data collected and used for the soil leaching model. Having a mixture of on-farm data collection and simulation modeling was challenging as well, because some participants were more comfortable than others with the assumption-making inherent in modeling.

We also encountered positive and negative aspects of the case study approach. On the positive side, working with commercial farms gave the project a strong practical focus and forced the participants to think about information that was useful to farmers. When a colleague was presenting material unfamiliar to others, the fact that the data were from farms that everyone was familiar with gave people a common base to relate to. Working with progressive producers gave the project a "real world" impetus and ensured that issues studied were pertinent and plans recommended were practical. Murray et al. (1994b) and Stevenson et al. (1994) raised the concern that research done on one or two farms may be too site-specific and cannot be transferred to other locations. We did not feel this was a great problem because although the results from the individual farms were site specific, the process is transferable to other farms.

The problems we encountered with the case study approach were inherent to the farms being active commercial farms. A large problem was in data collection. Much of the data that were useful and necessary for research were not needed for daily farm operation and were not routinely recorded by the producers. For example, although historical manure application records were needed for the analysis, they were not initiated on a quantitative basis until midway through the study period. A related problem was that the farms were continually changing even as data were being collected. Milk production, forage quality, animal rations, animal intake, and manure composition all varied from season to season and year to year. This made the interpretation of

results more difficult. In addition, because the scientific team did not control management practices on the farm, comparative experiments were impossible.

Finally, although this study resulted in a process for researching problems associated with sustainable agriculture, many questions that the participating farmers had at the beginning of the project remain unanswered: Does my farm currently have an environmental problem? Is there potential for future problems? What is the most profitable set of farming practices that will protect the environment? Because some of the information we generated is the first such information obtained, we have no basis of comparison with other farms and no standard to relate to. We know that developing and following an integrated set of management plans may limit potential problems. But, with current tools, we cannot definitively say whether the farms are currently causing a nonpoint-source water quality problem or are likely to have problems in the future. Future work in this area needs to focus on computerized tools to predict the interactions among farm components and determine the effects of management changes on nutrient flows and farm profitability.

CONCLUSIONS

The need for knowledge integration is central to efforts that seek to organize limited capital and human resources to achieve farm business and environmental goals. The following articles describe a process for integrating knowledge to promote sustainability from a nutrient management perspective. The results of the analyses are specific to the case study farms at the time of the research, but the process can be applied to other farms at other sites.

This report documents how we gathered and used data from two large dairy farms in Central New York, and our combined strategy for reducing the accumulation of nutrients on these farms. The result is a synthesis of information on the overall flows of N, P, and K within and across the farm boundaries and the associated costs and benefits of managing these nutrients.

REFERENCES

- Alatieri, M.A. 1989. Agroecology: a new research and development paradigm for world agriculture. *Agric., Ecosystems, and Envir.* 27:37-46
- Bacon, S.C., L.E. Lanyon, and R.M. Schlauder, Jr. 1990. Plant nutrient flow in the managed pathways of an intensive dairy farm. *Agron. J.* 82:775-761.
- Bawden, R. J. 1991. Systems thinking and practice in agriculture. *J. Dairy Sci.* 74:2362-2373.
- Coote, D.R., D.A. Haith, and P.J. Zwerman. 1975. Environmental and economic aspects of nutrient management on the New York dairy farm. *SEARCH Agriculture* 5(5), New York Agricultural Experiment Station, Cornell University, Ithaca, NY.
- Davenport, T.E. 1994. Keeping agriculture viable: EPA's perspective - you need to protect water quality. *J. Soil and Water Conserv.* 49:8-14.
- Dicks, M.R. 1992. What will be required to guarantee the sustainability of U.S. agriculture in the 21st century? *Amer. J. Alternative Agric.* 7:190-195.
- Dlott, J.W., M.A. Altieri, and M. Masumoto. 1994. Exploring the theory and practice of participatory research in U.S. sustainable agriculture: a case study in insect pest management. *Agric. and Human Values* 11:126-139.
- Domanico, S.L., P. Madden, and E.J. Partenheimer. 1986. Income effects of limiting soil erosion under organic, conventional, and no-till systems in Eastern Pennsylvania. *Amer. J. Alternative Agric.* 1:75-82.
- Dsouza, G.E., E.W. Maxwell, W.B. Bryan, and E.C. Prigge. 1990. Economic impacts of extended grazing systems. *Amer. J. Alternative Agric.* 5:120-125.
- Dunlap, R.E., C.E. Beus, R.E. Howell, and J. Ward. 1992. What is sustainable agriculture? An empirical examination of faculty and farmer definitions. *J. Sustainable Agric.* 3:5-39.
- Fox, D.G., M.C. Barry, R.E. Pitt, D.K. Roseler, and W.C. Stone. 1995. Application of the Cornell net carbohydrate and protein model for cattle consuming forages. *J. Anim. Sci.* 73:267-277.
- Francis, C. 1995. What is sustainability? p. 70-76. *In Proc. Agriculture and People - Building a Shared Environment.* 9-10 Oct. Univ. of Nebraska, Lincoln, NE.
- Fretz, T.A., D.R. Keeney, and S.B. Sterrett. 1993. Sustainability: defining the new paradigm. *Hort. Technol.* 3:118-126.

- Hildebrand, P.E. 1990. Agronomy's role in sustainable agriculture: integrated farming systems. *J. Prod. Agric.* 3:285-288.
- Hutson, J.L., and R.J. Wagenet. 1991. Simulating nitrogen dynamics in soils using a deterministic model. *Soil Use Management* 7:74-78.
- Hutson, J.L., and R.J. Wagenet. 1992. LEACHN -- Leaching estimation and chemical model, version 3. Research Series 92-3, Dept. of Soil, Crop, and Atmos. Sci., Cornell Univ., Ithaca, NY.
- Hutson, J.L., R.K. Koelsch, R.E. Pitt, and R.J. Wagenet. 1996. Integrating knowledge to improve dairy farm sustainability III: environmental losses and nutrient flows. (submitted).
- Johnson, S.L., R.M. Adams, and G.M. Perry. 1991. The on-farm costs of reducing groundwater pollution. *Amer. J. Agric. Econ.* 73:1063-1073.
- Karlen, D.L., M.C. Shannon, S.M. Schneider, and C.R. Amerman. 1994. Using systems engineering and reductionist approaches to design integrated farm management research programs. *J. Prod. Agric.* 7:144-150.
- Klausner, S.D. 1993. Mass nutrient balances on dairy farms. pp. 126-129 *In Proc. Cornell Nutrition Conf. Feed Manuf.*, Cornell University, Ithaca, NY.
- Klausner, S.D., D.G. Fox, T.P. Tylutki, W.C. Stone, L.E. Chase, and R.E. Pitt. 1996. Integrating knowledge to improve dairy farm sustainability II: plant and animal nutrient management. (submitted).
- Lanyon, L.E. 1992. Can a modern dairy farm be sustained? *J. Sustainable Agric.* 2:83-99.
- Lanyon, L.E., and D.B. Beegle. 1989. The role of on-farm nutrient balance assessments in an integrated approach to nutrient management. *J. Soil and Water Conserv.* 44:164-168.
- Lanyon, L.E., and H.K. Meij. 1992. FINFO: a field and farm technical information management program. *J. Prod. Agric.* 5:88-94.
- Lemberg, B., W.T. McSweeney, and L.E. Lanyon. 1992. An information management technology program for ex ante nutrient loss reduction from farms. *J. Environ. Qual.* 21:574-578.
- Lockeretz, W. 1991. Multidisciplinary research and sustainable agriculture. *Biol. Agric. Hort.* 8:101-122.
- Luna, J., V. Allen, J. Fontenot, L. Daniels, D. Vaughan, S. Hagood, D. Taylor, and C. Laub. 1994. Whole farm systems research: an integrated crop and livestock systems comparison study. *Amer. J. Alternative Agric.* 9:57-62.

- MacRae, R.J., S.B. Hill, J. Henning, and G.R. Mehuys. 1989. Agricultural science and sustainable agriculture: a review of the existing scientific barriers to sustainable food production and potential solutions. *Biol. Agric. Hort.* 6:173-219.
- Murphy, B. 1990. Pasture management. p. 226-237. *In* C. Edwards, R. Lal, P. Maddan, R.H. Miller, and G. House (ed.) *Sustainable Agricultural Systems*. Soil Water Conserv. Soc., Ankeny, IA.
- Murray, H.D., R. Dick, D. Green-McGrath, L.M. Butler, L.S. Lev, and R. Carkner. 1994a. Whole farm case studies of horticultural crop producers in the Maritime Pacific Northwest. *Agric. Exper. Sta., Oregon State Univ. Station Bulletin* 678.
- Murray, H. D., D. Green-McGrath, L.S. Lev, and A.M. Morrow. 1994b. Whole farm case studies: a how-to guide. EM 8558 Oregon State University Extension Service .
- Neher, D. 1992. Ecological sustainability in agricultural systems: definition and measurement. *J. Sustainable Agriculture*. 2:51-61.
- National Research Council. 1991. *Toward sustainability: a plan for collaborative research on agriculture and natural resource management*. National Acad. Press, Washington, DC.
- New York Agricultural Statistics Service. 1995. *New York agricultural statistics 1994-1995*. New York State Dept. Agric. and Markets, Div. of Statistics, Albany, NY.
- Oberle, S.L., and D.R. Keeney. 1991. A case for agricultural systems research. *J. Environ. Qual.* 20:4-7.
- Peters, S., R. Andrews, and R. Janke. 1988. Rodale's farming systems experiment 1981 to 1987. p. 15-23. *In* Proc. Second Annual Virginia Conf. Sustainable Agric. Virginia Coop. Ext. Service 444-700.
- Rasmussen, C.N., J.J. Hanchar, and P.E. Wright. 1996. Integrating knowledge to improve dairy farm sustainability IV: economic evaluation of alternatives to improve nutrient efficiency. (submitted).
- Rotz, C.A., J.R. Black, D.R. Mertens, and D.R. Buckmaster. 1989. DAFOSYM: a model of the dairy forage system. *J. Prod. Agric.* 2:83-91.
- Schmit, T.M., and W.A. Knoblauch. 1994. The impact of nutrient loading restrictions on dairy farm profitability. *J. Dairy Sci.* 78:1267-1281.
- Smolik, J.D., and T.L. Dobbs. 1991. Crop yields and economic returns accompanying the transition to alternative farming systems. *J. Prod. Agric.* 4:153-161.

- Stevenson, G.W., J. Posner, J. Hall, L. Cunningham, and J. Harrison. 1994. Addressing the challenges of sustainable agriculture research and extension at land-grant universities: radically organized teams at Wisconsin. *Amer. J. Alternative Agric.* 9:77-83.
- Stockle, C.O., R.I. Papendick, K.E. Saxton, G.S. Campbell, and F.K. van Evert. 1994. A framework for evaluating the sustainability of agricultural production systems. *Amer. J. Alternative Agric.* 9:45-49.
- Temple, S.R., D.B. Friedman, O. Somasco, H. Ferris, K. Scow, and K. Klonsky. 1994. An interdisciplinary experiment station-based participatory comparison of alternative crop management systems for California's Sacramento Valley. *Amer. J. Alternative Agric.* 9:64-71.
- Weiss, A., and J.G. Robb. 1988. Systems and the business of agriculture. *J. Prod. Agric.* 1:230-234.
- Westphal, P.J., L.E. Lanyon, and E.J. Partenheimer. 1989. Plant nutrient management strategy implications for optimal herd size and performance on a simulated dairy farm. *Agric. Systems* 31:381-394.

**Integrating Knowledge to Improve Dairy Farm
Sustainability - Part II:**

Plant and Animal Nutrient Management

S.D. Klausner, D.G. Fox, T.P. Tylutki,
W.C. Stone, L.E. Chase, and R.E. Pitt

ABSTRACT

A process to design animal and crop nutrient management plans was developed and used on two New York dairy farms (A and B). Mass balances of N, P, and K for these farms indicated that over 60% of the nutrient imports from purchased feeds, fertilizers, and symbiotic N fixation was not accounted for in the nutrient exports of milk and animals. In most cases, the greatest percentages of nutrient imports were associated with purchased feeds. A dynamic model of cattle nutrient utilization on Farm A indicated an excess of degradable protein in the diet and an energetic cost of excreting excess ammonia. Reformulation of diets resulted in an increased use of farm produced alfalfa silage, corn silage, and high moisture ear corn; a reduction in crude protein content of the rations of 2 percentage points; and a 25 to 40% reduction in N, P, and K while supporting a 13% increase in milk production. A step-by-step process of nutrient management planning for efficient use of manure nutrients resulted in the substantial replacement of commercial fertilizers. Soil testing, manure analysis, feed ingredient analysis, and monitoring of animal dry matter intake were among the critically important tools in this process.

INTRODUCTION

Reducing nitrate contamination of groundwater and phosphorus enrichment of surface waters has become an important regional and national goal. Water quality concerns, in combination with potential or enacted nutrient management legislation in many states, have created a renewed awareness of the need for efficient nutrient management in dairy farming. However, most livestock farms do not follow a comprehensive nutrient management plan that encompasses both plant and animal requirements. This lack of planning increases the potential for environmental pollution from farms (Lanyon, 1994).

Nutrients accumulate on a farm if a greater quantity is imported as purchased feeds, fertilizer, and symbiotic N fixation than is exported as products sold. Mass nutrient balances on three New York dairies (Klausner, 1993) showed that 64 to 76% of N, 68 to 81% of P, and 67 to 89% of K imported each year were retained on the farm. These high net excess rates were a reflection of individual feeding and fertilizing practices but were not related to farm size, which varied from 45 to 1,300 cows. The largest source of imported nutrients was purchased feeds, which accounted for 62 to 87% of imported N, 45 to 81% of imported P, and 16 to 62% of imported K (Klausner, 1993).

Because purchased feeds are the primary source of nutrient imports, ration formulation has a significant impact on a farm's nutrient status. Changes in the types of feeds purchased, the balance between forage and concentrate, and the ratio of corn silage to haycrop can affect substantially the imports of purchased feeds. These changes also affect fertilizer usage. Crop land areas may change as the feeding program is adjusted. Also, the nutrient composition of the manure and its ability to replace commercial fertilizers is affected by animal nutrition (Pell, 1992; Tamminga, 1992).

The purpose of this part of the study was to assess the overall nutrient status of the two case study farms in this project and to develop animal and crop nutrient management plans. These plans incorporated assessment of nutrient imports and exports; evaluation of changes in animal diets; assessment of manure and soil nutrient status; and recommendations for manure and fertilizer application with respect to crop nutrient requirements and soil and water conservation

objectives. Further evaluation of the environmental impacts and the economic costs and benefits are considered in Parts III and IV (Hutson et al., Rasmussen et al.).

MATERIALS AND METHODS

The two case farms (A and B) were large dairy farms in Central New York (Part I, Fox et al.). Mass nutrient balances, soil/crop nutrient management plans and ration evaluation are presented for both Farms A and B. Acreages and animal numbers were provided in Table 2 of Part I (Fox et al.). Soils on both farms were well drained to moderately well drained Honeoye-Lima-Kendaia complex (fine loamy, calcareous glacial tills) with slopes primarily less than 6%.

Imports of feeds, fertilizers, and animals were determined using annual farm expense records for 1993. Annual sales records were used to determine exports of milk and animals. No crops were sold off the farms. Changes in inventory and open accounts from year to year were unavailable but were assumed to be small enough to be unimportant. Acres of legumes (entirely as alfalfa) and percent alfalfa in the stand were used to estimate symbiotic N fixation. Forage analyses of all home grown feeds were collected routinely by the farmers; analyses were performed by the Northeast Dairy Herd Improvement Association (DHIA, Ithaca, NY). Nutrient composition of purchased feeds was specified by the supplier. For planning purposes, crop yields were projected from soil potential. The N fixation per unit land area was estimated as 40% of the legume N content (Heichel et al., 1981, 1984). Nutrient composition of purchased cattle was estimated from Nour and Thonney (1988). Nutrient concentrations in milk sold were determined by DHIA.

The Cornell Net Carbohydrate and Protein System (CNCPS) was used to evaluate cattle nutrient utilization. The CNCPS model integrates information on animal breed and frame size, thermal environment, feed composition and intake, and digestion and passage rates to predict animal performance, feed energy values, site of digestion and use of dietary protein, and ruminal microbial growth efficiency (Fox et al., 1995). Farm specific inputs were used in the model, and the extent to which microbial nutrient requirements and animal energy and protein requirements were deficient or in excess was determined.

A single diet evaluation was done for Farm B and more complex series of evaluations was conducted for Farm A. For Farm A, evaluation of diets was carried out for lactating cows divided into four stages of lactation, for two heifer groups divided by age, and for two dry cow groups divided by closeness to calving. Dry matter intakes, body condition scores, barn ambient temperatures, and other inputs for the model were collected within two days of the sample day each month for the DHIA. Ration ingredients as a percentage of diet dry matter were determined at or within 2 days of the time that intakes were determined. All lactating cows were body taped for the first three evaluations in order to estimate each group's average body weight. Nearly all cows were body condition scored each month. Beginning in October 1992, the group's average weights were adjusted for body condition score with a conversion of 60 lb per condition score unit (1 to 9 scale). Ambient maximum and minimum temperatures were determined daily from thermometers inside the barns (Ithaca temperatures were used when readings were not taken). Hair depth was estimated each month. Forages were analyzed by DHIA for concentrations of dry matter, NDF, crude protein, soluble protein, acid detergent insoluble N, and minerals every two months or sooner if the forages appeared to change. Concentrates were analyzed similarly every three months.

The diet evaluation in June 1991 was used to establish a baseline for both milk production and feed costs per unit of milk. The CNCPS was used monthly to evaluate and then reformulate rations between August 1991 and November 1993. Rations were reformulated depending on milk production, intake, body condition, feed analysis, feed costs, appearance of manure and feed, and feed inventories.

In spring 1994, soil samples were taken from the plow layer (0 to 10 in) from all production fields and analyzed for pH and Morgan-extractable P, K, Ca, Mg, Fe, Al, Mn, and Zn. Acreage, soil type, soil characteristics, and crop rotation were recorded for each field. Manure application rates were recorded for 6 months by the farmer in 1994 for Farm A and estimated by the farmer for Farm B. Manure production was estimated from the volume of the spreader and the number of loads removed each month. Manure analyses were performed in December of 1990 and June and November of 1993 for dry matter, total N, organic N, ammoniacal N, total P, and total K. Soil nutrient requirements were based on Cooperative Extension recommendations (Cornell, 1993).

RESULTS AND DISCUSSION

Mass Nutrient Balances

An illustration of the nutrient flows assessed on these farms is shown in Figure 1. Nutrients were brought onto the farms in purchased feeds, fertilizers, and animal replacements. Nutrients were also imported in the conversion of atmospheric N into plant proteins by legumes, and to a lesser extent, precipitation. Nutrients left the farms in products sold as milk, animals, and crops.

Figure 1. Illustration of typical nutrient flows on a dairy farm.

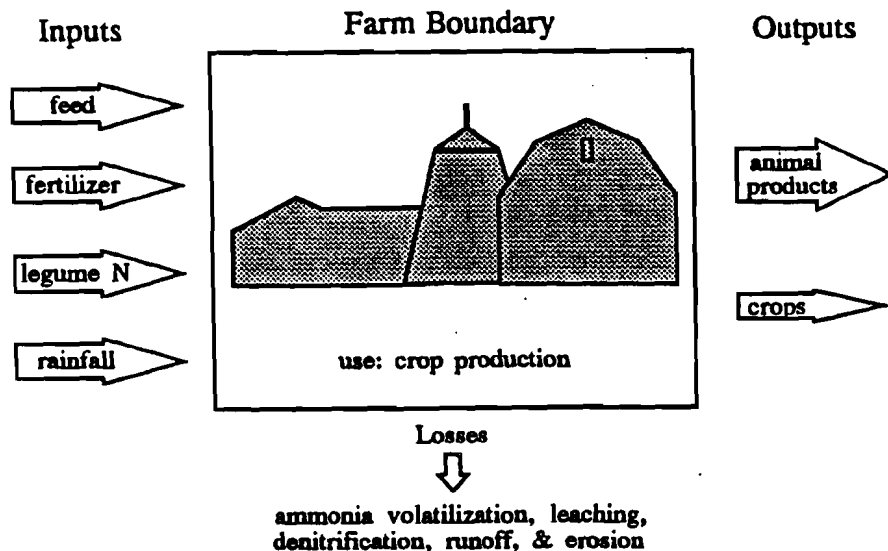

Table 1 shows the nutrient imports and exports for Farm A. Total imports of N were 72 tons/yr. Measured exports as milk and animals totaled 21 tons/yr. The difference between imports and exports was 51 tons/yr, which was 72% of the imports. Thus, over two-thirds of the imported N was retained on the farm that year. Mass balances for P and K (Table 1) also showed that imports exceeded exports, with net excess rates of 59 and 71%, respectively.

Table 1. Annual mass nutrient balances for Farm A.

	N	P	K
	tons/yr		
Imports			
Purchased feeds	43.8	8.4	12.3
Fertilizers	13.5	2.0	7.3
N fixation	14.6	0	0
Purchased animals	<u>0.1</u>	<u>0.03</u>	<u>0.01</u>
Total	72.0	10.4	19.6
Exports			
Milk	18.6	3.8	5.6
Animals	<u>1.9</u>	<u>0.5</u>	<u>0.1</u>
Total	20.5	4.3	5.7
Net excess rate			
tons/yr	51.5	6.1	13.9
% of imports	72	59	71

For Farm B (Table 2), the magnitudes of imports and exports were larger than Farm A because of larger animal numbers (1.6 times the number of lactating cows). Nutrient imports from purchased feeds were greater than Farm A by a factor of 1.8 for all nutrients. For fertilizers, nutrient imports were greater than Farm A by factors of 1.9, 5.0, and 4.8 for N, P, and K, respectively. Imports from N fixation were similar on the two farms because the acreages of alfalfa were similar.

Table 2. Annual mass nutrient balances for Farm B.

	N	P	K
	tons/yr		
Imports			
Purchased feeds	78.5	14.2	22.8
Fertilizers	26.1	10.0	35.1
N fixation	13.9	0	0
Purchased animals	<u>0</u>	<u>0</u>	<u>0</u>
Total	118.5	24.2	57.9
Exports			
Milk	26.4	5.5	8.3
Animals	<u>1.9</u>	<u>0.5</u>	<u>0.1</u>
Total	28.3	6.0	8.4
Net excess rate			
tons/yr	90.2	18.2	49.5
% of imports	76	75	85

Milk nutrient exports were higher on Farm B by a factor of about 1.5 for N, P, and K; this ratio is close to that of lactating cow numbers for the two farms because milk production per cow was comparable. Net excess rates of N, P, and K as a percentage of imports were comparable for N but higher for P and K on Farm B.

Partitioning of the various nutrient imports is shown in Table 3. For both farms, purchased feeds accounted for the largest share of imported nutrients in almost all cases. However, fertilizers represented a larger percentage on Farm B than Farm A, and imports of fertilizer K exceeded purchased feeds on Farm B. These results indicate that Farm B was more liberal in its use of fertilizers than Farm A.

Table 3. Relative contribution of nutrient sources on Farms A and B.

Import	Farm A			Farm B		
	N	P	K	N	P	K
	% of imports					
Purchased feeds	61	81	63	66	59	39
Fertilizer	19	19	37	22	41	61
N fixation	20			12		

Further assessment of the nutrient status of the two farms is shown in Table 4, which compares nutrients collected in manure with crop nutrient requirements. Nutrients in manure exceeded crop requirements. N fixation by alfalfa, in addition to high soil test levels of P and K as a result of previous overapplications of fertilizer and manure, reduced the need for supplemental nutrients. The quantity of total nutrients per unit of tillable land area was comparable on the two farms because of similar animal densities (Table 4). However, there is a difference between amounts of total and plant-available nutrients per tillable acre. The nutrients in manure cannot be

substituted for fertilizer on a pound-for-pound basis, because manure nutrients are not as readily available nor can their application be as carefully timed or placed as fertilizer. An apparent surplus of manure nutrients on these farms, in terms of total quantity (Table 4), may not provide a sufficient amount of available nutrients to meet crop requirements. This is especially true for N.

Table 4. Comparison between manure nutrients produced and total crop nutrient requirements, manure nutrients per tillable land area, and animal densities for Farms A and B.

Farm	Nutrient	Manure nutrient production	Total crop nutrient requirement		Surplus nutrients	Manure nutrients per tillable land area	Animal density
			tons/yr				
						lb/(acre•yr)	animal units/acre [†]
A	N	55.3	16.8		38.5	185	1.1
	P ₂ O ₅	24.2	6.3		17.9	81	
	K ₂ O	41.6	7.3		34.3	139	
B	N	89.3	38.4		50.9	165	0.9
	P ₂ O ₅	38.5	9.5		29.0	70	
	K ₂ O	71.4	9.3		62.1	135	

[†] 1 animal unit = 1000 lb body weight.

The mass nutrient balances were useful as a tool to identify focal areas for management. The mass balances on these and other New York dairy farms (Klausner, 1993) showed that purchased feed was the primary source of imported nutrients (Table 3). When the imported nutrients in fertilizer exceed that in feed, it is the result of a low animal to land ratio or excessive fertilizer purchases, as was the case for K on Farm B. Matching feed and fertilizer purchases to actual need should help reduce nutrient imbalances and excessive nutrient loss (Hutson et al., 1996).

The fate of surplus nutrients on these farms was not known. Much of surplus P and K can remain in the soil, although a relatively small amount may be stored temporarily in crops before being recycled to the soil in crop residue and manure. Some P and K may be lost from the farm primarily in runoff and erosion. Nutrient accumulation would be reflected in a long term increase in soil-test P and K levels. Thus, soil testing serves as the single most important tool for managing P and K. Nitrogen does not accumulate appreciably in soil, and much of the available soil N can be lost by runoff, erosion, leaching, and denitrification (Hutson et al., 1996).

Animal Nutrient Management

Mass balances indicated that approximately 72% and 76% of the imported nitrogen was retained annually on Farm A and Farm B respectively. The CNCPS was used to evaluate alternative strategies that would reduce imported N while keeping milk production at current levels.

On Farm B, the current ration was compared to a ration designed to reduce imported feed by 50% (Table 5). Homegrown high moisture corn maximized ruminal microbial amino acid production while taking advantage of the degradable intake protein (DIP) in the alfalfa. Ladino clover was used to balance fiber and nitrogen requirements, and corn meal was used to balance energy requirements that remained. Soybean meal was imported as the only source of supplemental N to provide supplemental peptides to maximize microbial amino acid production from the high moisture corn starch. With this combination, imported N was reduced to 13% of the total fed. Diets for the replacement heifers were designed using high moisture ear corn and hay crop silage only.

Table 5. Feed Requirements and N Excretion Predictions for Farm B when Attempting to Reduce Imported Feed by 50%^{†‡}.

Feed	Current amounts		Proposed amounts	
	acres	tons	acres	tons
From crops grown				
Corn Silage	394	2094	0	0
Alfalfa	367	1130	313	1501
Grass	43	136	0	0
H.M. ear corn	210	455	364	1819
Ladino clover	0	0	600	1501
From purchased feed				
Soy plus		225		0
Soy 49		301		124
Whole cotton		326		0
Fat		24		55
Corn meal		551		590
Wet Brewers Grains		298		0
Hay		90		0
Minerals		132		163

[†] 500 cows averaging 74 lbs/d (26,500 lbs RHA), 350 heifers.

[‡] In current system, 75 tons N grown (48% of total N in ration) and 80 tons purchased (52% of total N in ration), with 32 tons exported as milk (20% of total N excreted) and 107 tons excreted as manure (80% of total N excreted). In proposed system, 137 tons N grown (87% of total N in ration) and 20 tons N are purchased (13% of total N in ration), 32 tons exported as milk (20% of total N excreted) and 114 tons excreted as manure (80% of total N excreted).

The CNCPS was used to balance diets for Farm A. These rations were fed and the results collected and analyzed over a 13 month period. Table 6 shows the base ration in June 1991 for one cow group (early lactation mature cows). In this ration, forages accounted for 35% of the diet, high moisture ear corn 21%, and purchased feeds 44%. The CNCPS was used to evaluate the balance between supply and requirement of metabolizable energy (ME) for the whole animal; supply and requirement of metabolizable protein (MP) for the whole animal; production of bacterial protein in the rumen; supply of feed bypass protein to the lower tract; supply and

requirement of ammonia and peptides for ruminal bacteria; and fiber requirements for proper rumen function. Dry matter intake was predicted from milk production, thermal environment, and feed description, and was close to actual intake (Table 6). The ME supply was closely balanced to the animal requirement (ME balance of -0.1 Mcal/day). The MP balance was positive (supply exceeded requirement) but was within 5% of requirement. The bacterial N and peptide balances were positive.

In the rumen, some of the feed protein is degraded to peptides and ammonia which are required by ruminal bacteria; the positive balances on these constituents indicates an excess supply. Excess ammonia is absorbed through the rumen wall and excreted as urea, but there is an energetic cost of converting ammonia to urea. This "urea cost" was almost 1 Mcal/d, which was unusually high and substantially increased the ME requirement. The predicted plasma urea nitrogen (PUN) of 16.4 mg % showed excess urea in the blood. Amino acid supply can limit animal performance; sources of amino acids include ruminal bypass protein and microbial protein. The first limiting amino acid was methionine, the requirement for which was just being met (supply = 102% of requirement).

Overall, the diet of June 1991 suggested an excess of degradable protein and an energetic cost of excreting excess ammonia. Between June 1991 and March 1992, a series of adjustments were made in the diet to address the apparent N utilization problem as well as changes in milk production, animal intake, thermal environment, and feed characteristics. Table 6 shows the reformulated ration for this cow group after ration adjustments had stabilized and milk production had increased to 108 lb/d. Intake of corn silage and high moisture ear corn (HMEC) was increased, some of the soybean meal (SBM) was replaced with a heat treated soybean product which is a source of rumen-bypass protein, and the total number of dietary ingredients was reduced from 9 to 7. In the new ration, forages accounted for 40% of dry matter, and purchased feeds were reduced to 30% of the diet. Diet crude protein was reduced by almost 2 percentage points from the base ration. Purchased feed costs were lower by an average of \$0.64/(cow•day) for the affected groups. Changes in net farm income as a result of ration reformulation are estimated in Part IV.

Table 6. Results of implementing the CNCPS on Farm A, showing a base ration (June 1991), a reformulated ration (March 1992) for early lactation mature cows, and sensitivity to changes in dry matter intake (DMI), forage NDF content, effective NDF (eNDF) content, soluble protein (SolP) level, and starch digestibility.

	Base 6/91	Re-Bal 3/92	Sensitivity Analysis				
			DMI [‡]	NDF [§]	eNDF [¶]	SolP [#]	Starch ^{††}
Diet Dry Matter, lb/day [†]							
Corn silage	12.7	16.7	15.0	16.7	16.7	16.7	16.7
Alfalfa silage	5.3	6.5	5.8	6.5	6.5	6.5	6.5
HMEC	10.9	16.4	14.7	16.4	16.4	16.4	16.4
Treated SBM		7.2	6.5	7.2	7.2	7.2	7.2
SBM	10.4	2.9	2.6	2.9	2.9	2.9	2.9
WCS	5.6	5.8	5.2	5.8	5.8	5.8	5.8
Protein mix	1.0						
Corn grain	4.6						
Tallow	0.5						
Minerals	0.7	2.0	1.8	2.0	2.0	2.0	2.0
Total DMI, lb/day	51.8	57.5	51.5	57.5	57.5	57.5	57.5
Predicted DMI, lb/day	52.2	56.2	56.2	56.2	56.2	56.2	56.2
Diet CP, % dry matter	20.2	18.2	18.2	18.2	18.2	18.2	18.2
NSC, % dry matter	40	44	44	49	44	44	44
Actual milk, lb/day	95.6	108.1	108.1	108.1	108.1	108.1	108.1
ME allowable milk, lb/day	95.4	104.2	91.9	110.4	104.2	103.7	100.0
ME balance, Mcal/day	-0.1	-2.0	-8.1	1.0	-2.0	-2.2	-4.0
MP balance, lb/day	0.410	0.58	-0.03	0.72	0.22	0.80	-0.46
MP from bacteria, lb/day	3.31	3.64	3.34	3.61	3.23	3.65	2.65
MP from feed, lb/day	3.20	3.81	3.31	3.83	3.85	4.01	3.81
Bacterial N balance, lb/day	0.31	0.13	0.12	0.13	0.23	0.09	0.39
Peptide balance, lb/day	0.17	-0.01	0.01	-0.03	0.05	0.04	0.16
Urea cost, Mcal/day	0.96	0.48	0.00	0.59	0.49	0.66	1.11
Days to CS change	2253	141	35	284	146	129	71
eNDF supplied, lb/day	10.8	11.0	9.9	9.3	8.4	11.0	11.0
eNDF required, lb/day	10.4	11.5	10.4	11.5	11.5	11.5	11.5
Predicted ruminal pH	6.30	6.24	6.24	6.11	6.04	6.24	6.24
Predicted PUN, mg % ¹	6.4	13.0	10.0	14.0	13.0	15.0	17.0
Limiting AA	MET	MET	MET	MET	MET	MET	MET
Limiting AA, % req.	102	107	99	109	98	109	85

[†]HMEC = high moisture ear corn; SBM = soybean meal; WCS = whole cottonseed; DMI = dry matter intake; CP = crude protein; NSC = nonstructural carbohydrates; ME = metabolizable energy; MP = metabolizable protein; CS = condition score; eNDF = effective NDF; PUN = plasma urea nitrogen; AA = amino acid; MET = methionine.

[‡]DMI reduced to base level, June 1991.

[§]NDF content of forages reduced by 1 standard deviation as reported by DHIA.

[¶]Effective NDF values of all diet ingredients reduced by 25%.

[#]Protein solubility of all diet ingredients reduced by 1 standard deviation as reported by DHIA.

^{††}Ruminal starch digestion rate reduced to 5%/h, and gross intestinal digestibility of starch reduced to 50%.

Despite the reduction in diet crude protein, the MP balance for the animal was in greater excess than with the base diet, and the amino acid requirement was still being met. Substitution of heat treated SBM for other sources of protein reduced substantially the degradability of protein in the rumen. This had a number of benefits. A closer balance between supply and requirement of ammonia and peptides in the rumen was effected, which had the secondary benefit of reducing PUN, urea cost, and ME requirement. Using a higher percentage of corn silage and HMEC in the ration increased the energy density of the diet. An associated benefit was that production of microbial protein was increased as a consequence of increased microbial yield on more rapidly fermentable carbohydrates. Actual milk production, which had been accurately predicted in the base ration, now exceeded predicted milk production based on ME supply (ME-allowable milk). Dry matter intake exceeded predicted intake by 1.3 lb/day.

Table 6 shows sensitivity of the model predictions to problems encountered between June 1991 and March 1992, including a transient drop in intake and production during hot weather in August, a sudden reduction in fiber (NDF) content of the corn silage, changes in forage particle size, changes in soluble protein contents, and apparent reduction in total digestibility of starch (intact kernels appearing in manure). Increased ambient temperature can induce heat stress in cattle, depressing dry matter intake. When intake was reduced from March 1992 to June 1991 levels (Table 6), ME-allowable milk production declined 12.3 lb/day. This is similar to the decreases that were actually seen. ME and MP balances became negative, showing that animal energy and protein requirements were not being met. Insufficient ME causes animals to lose body condition; the model predicted an increased rate at which animal body condition was decreasing (time to change in condition score was smaller). Supply of methionine also fell slightly below requirement.

When forage NDF was reduced by one standard deviation in values measured by DHIA (after restoring dry matter intake to its March 1992 level), the ME balance was increased by 3 Mcal/day and the ME allowable milk production by 6.2 lb/day (Table 6). Lower NDF in the forage results in higher concentration of nonstructural carbohydrates (NSC), which are fermented rapidly in the rumen. Thus, rumen microbial growth was increased, resulting in higher MP from bacteria. The higher NSC increased the MP and methionine balances, but peptides for ruminal NSC bacteria were in greater shortage. Reduction in NDF also reduced effective NDF (eNDF), which is the portion of NDF that stimulates rumination, saliva production, and rumen motility, all of which promote normal ruminal pH. The predicted ruminal pH was 6.1, which is below the pH for maximum fiber digestion and is at the point of highest sensitivity of rumen fiber-digesting bacteria to pH. Overall, lower NDF increased growth of bacteria on rapidly digestible carbohydrates but inhibited the growth of fiber digesting bacteria.

Effects of reducing effective NDF, keeping NDF in the ration at its original level, are shown in Table 6. Reduction in eNDF with no change in NDF is possible when forage particle size is reduced by chopping more finely. Predicted ruminal pH decreased to 6.0, thereby reducing fiber digestion in the rumen and production of MP from bacteria, and increasing the ruminal N and peptide balance. Methionine became deficient because of the loss of bacterial supply from the rumen.

When protein solubility was decreased (Table 6), the MP from feed increased substantially, causing a rise in the overall MP balance. However, predicted PUN and urea cost rose significantly. Finally, ruminal digestion rate of starch in the corn silage was decreased and gross intestinal digestibility was reduced, to reflect a high percentage of whole kernels in the corn

silage and visible presence of undigested corn kernels in the manure. These effects caused microbial protein production to fall and an MP shortage of 0.46 lb/day (Table 6). Amino acid requirements were also unmet. ME balance decreased by 2 Mcal/day, and the ME allowable milk dropped by 4.2 lb/day. These results suggest why excessive body condition loss occurred during one month.

Use of the CNCPS to improve nutrient use efficiency required superior information collection and feeding management. Specifically, implementation of the CNCPS required:

1. Close monitoring of dry matter intake, and early identification of feed intake problems when they arose.
2. Frequent and accurate feed analysis to describe carbohydrate and protein fractions, so that ruminal carbohydrate and N requirements and animal energy and amino acid balances could be assessed.
3. Careful attention to bunker-silo and feed-bunk management to preserve forage quality and optimize feed intake and rumen function.
4. Effective control of ration mixing and delivery, to ensure that the ration as designed was actually available to the cow.
5. Close monitoring of animal response in terms of milk production and body condition.

The farms in this study were capable of carrying out all five control measures effectively. Even so, rations were formulated to include 5% more ammonia, peptides, and MP than required to allow a safety factor for day-to-day variations in feed composition and ingredient weighing and mixing. In the situations we have evaluated, rarely is ammonia deficient; often it is in excess because of the degradable protein in silages. This example shows the importance of being able to account for the plant and animal interaction in improving whole farm nutrient balance. Maturity at harvest affects the energy, fiber, water and protein content of the feeds. The chemical and physical composition of the silage affects rumen function and animal efficiency. For example, harvesting alfalfa at an immature stage increases the energy value and total protein content. However, the degradable protein intake may be increased because of the lower cell wall content of the forage and likely higher water content of the forage at ensiling. Also the effectiveness of the fiber in maintaining an optimum pH in the rumen for maximum fiber digestion may be decreased.

Harvest management of alfalfa is also crucial to improving nutrient usage by cattle, including maturity effects on digestible energy, fiber intake, effectiveness of fiber, protein content, protein solubility, and physical processing. For example, harvesting alfalfa at an early stage of maturity (less than 10% bloom) increases the apparent energy value and protein content; however, protein degradability may also be increased, rendering the usage of N less efficient, and the effective fiber requirement which maintains normal ruminal pH and maximum fiber digestion may be not be met. On Farm A, alfalfa crude protein levels ranged from 22 to 24%, NDF from 35 to 43%, and ADF from 30 to 35%; these values indicate good forage quality and a high level of harvest management on this farm.

Changes in milk production and excretion of total N, organic N, and ammonia N are shown in Figure 2 for the whole herd at the three manure sampling times. Cow numbers varied by less than 4% during this period. Even though milk production was rising, excretion of total N, organic N, and ammoniacal N decreased by about 34, 15, and 50%, respectively, over the test period. These reductions result from both reduced intake of N and more efficient utilization of N.

Similar reductions in excretion of P and K were seen (Figure 3). Reductions in excreted P follow from reduced intake of purchased feeds, because concentrates which are sources of N tend also to be high in P. Reductions in excreted K were not caused by reduced intake of K, because most of the ration K was derived from alfalfa, and intake of alfalfa was not decreased. Evidently, the efficiency of K utilization by the animals was increased. Changes in manure nutrient concentrations had direct effect on the crop/soil nutrient management plan described next in this paper.

These results reveal some of the issues surrounding improvement of nitrogen imbalances on farms. There are three choices to reduce this imbalance; export some of the manure, have more acres per cow, and/or evaluate different combinations of crops, acres and cows. With less purchased feed, more metabolizable protein must be produced from home grown feeds, requiring optimizing ruminal production of amino acids. Assuming in either case the ration is optimally balanced for carbohydrate and protein fractions with little excess, approximately the same tonnage of nitrogen will be fed to the animals in the revised cropping program, and approximately the same tonnage of nitrogen must cross the farm boundaries, either through nitrogen fixation or as fertilizer N. However, if when compared to the current system the total amount of N fed for the same level of production is decreased less N will enter the farm. By balancing with little wastage while managing to minimize safety factor needed, the overall N, P and K balances of the farm can be improved. Thus, after optimizing N use by the cattle, the opportunities to improve nitrogen balances on farms are through better use of manure nutrients or through lower losses associated with nitrogen fixation.

Figure 2. Changes in milk production and total N, organic N, and ammonia N from manure for Farm A at three time points.

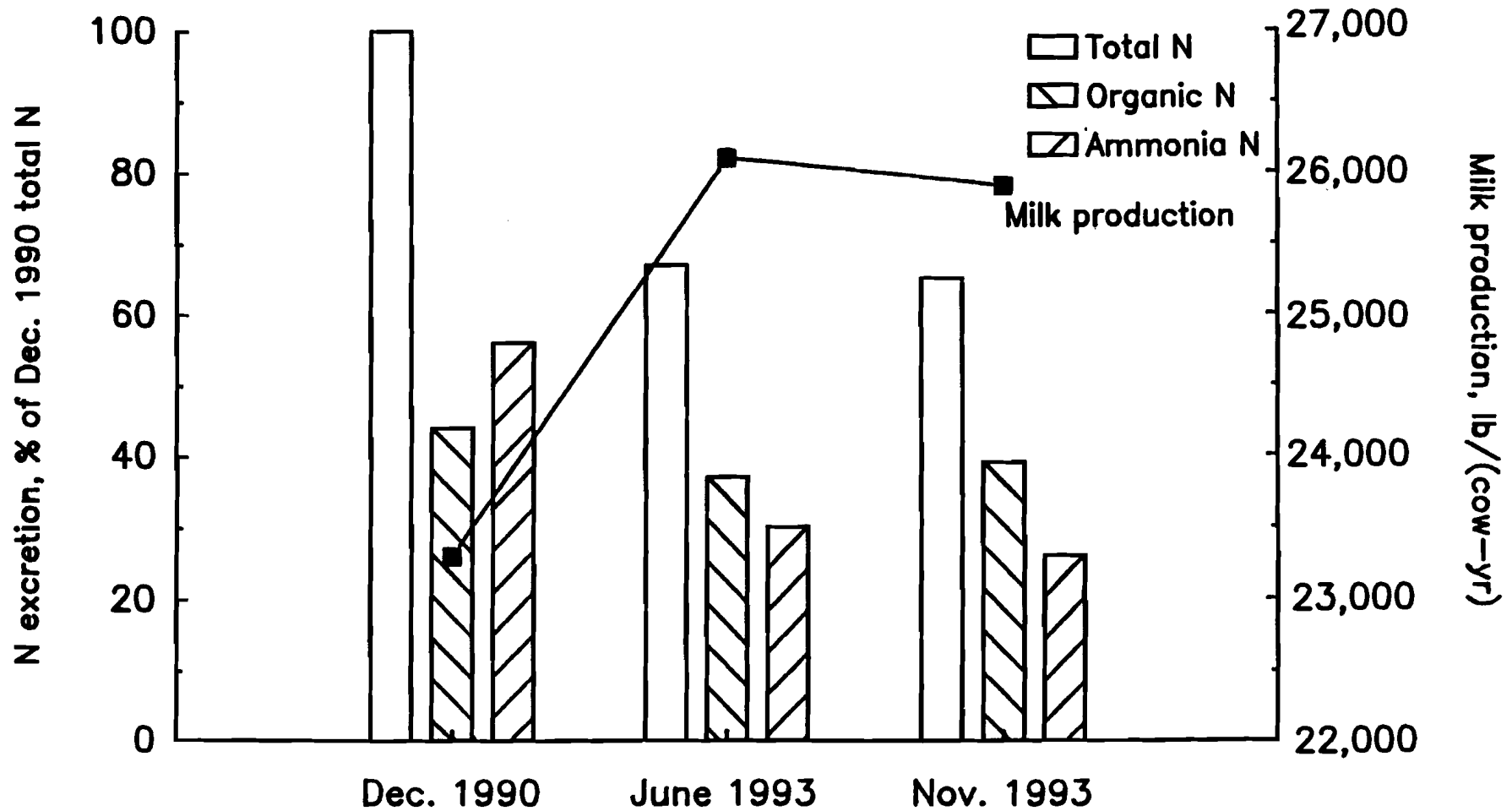
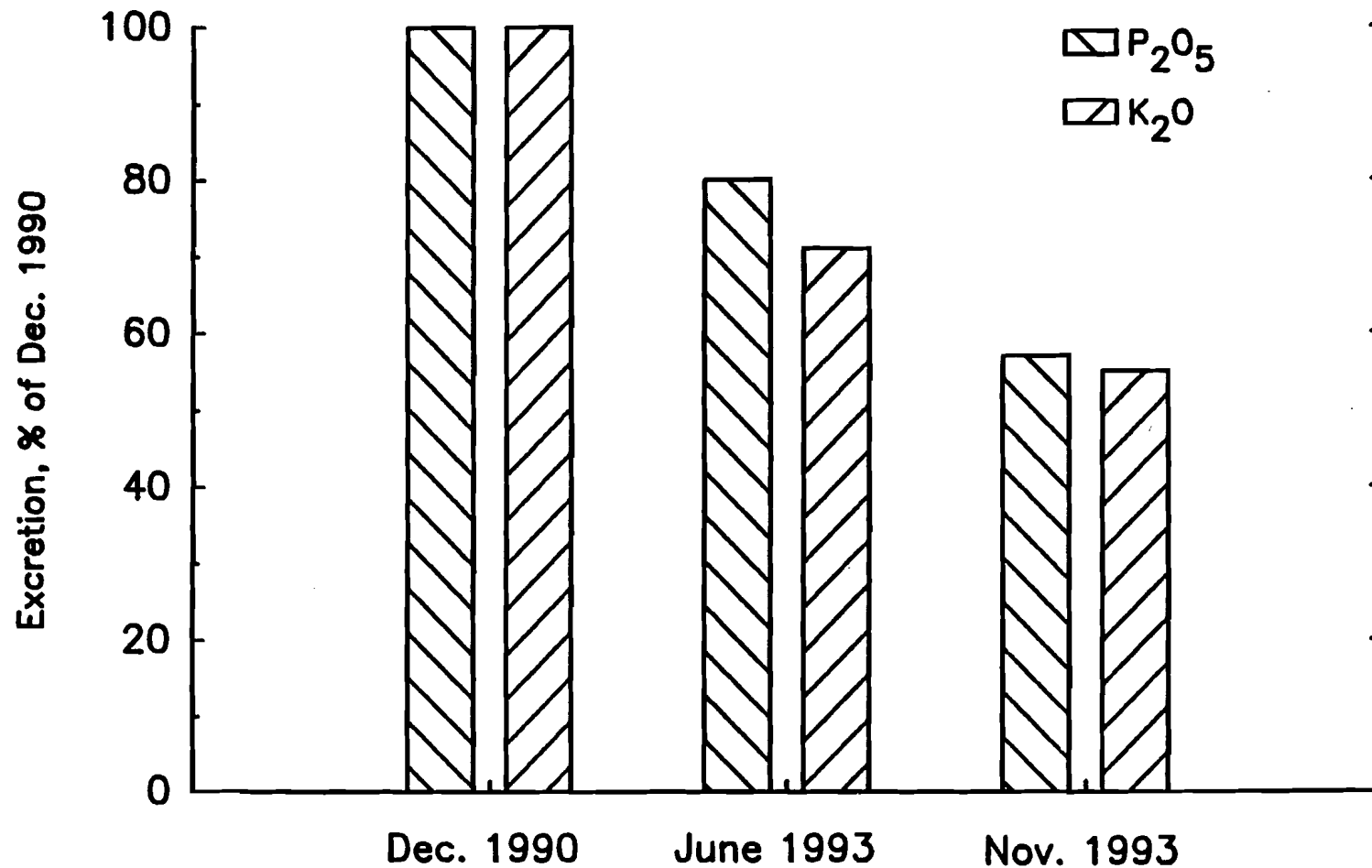

Figure 3. Changes in production of P_2O_5 and K_2O in manure from Farm A at three time points.



Crop Nutrient Management Planning

The surplus of nutrients imported onto Farms A and B suggested that crop nutrient management planning could have a positive impact on mass nutrient balances. The goal in nutrient management planning on these farms was to assure an adequate and sustained supply of high quality feed and improved nutrient recycling. Soil and manure analyses were central components of the planning process. The soil fertility program focused on the use of manure as the major source of plant nutrients, and fertilizer used only to supplement additional needs. In the nutrient management planning process, residual soil fertility was assessed, and a major portion of the crop nutrient requirements was supplied by manure. Any supplemental requirements were supplied with commercial fertilizers.

The steps taken to develop the crop nutrient management plan for Farm A are discussed below. Supportive documentation is presented in Klausner (1995).

Step 1. Determine number of animal units (1 unit = 1000 lb).

The number of mature animals, heifers, and calves was multiplied by average body weight for each group. Total weight was divided by 1000. Farm A had 678 animal units. Farm B had 943 animal units.

Step 2. Estimate quantity of manure collected annually.

Three separate methods can be used to estimate manure production.

- a) Determine number of spreader loads removed from the barns or storage per unit of time. Multiplying number of loads by capacity of spreader when normally loaded by the appropriate time factor gives annual production.
- b) Calculate volume of manure in storage. Divide the quantity in storage by the amount of time since storage was last emptied (expressed as a percent of the year, e.g., 6 months = 0.5). Multiplying by the appropriate time factor gives annual quantity.
- c) Calculate the manure production per animal unit (ASAE, 1995) and multiply by number of animal units. This method is considered the least reliable because it is based on data from 1976, and the dry matter intake per unit body weight of high producing cows has increased substantially since then.

Tables 7 and 8 give the quantity of manure collected from each of the sources on Farms A and B using method (a) above.

Table 7. Quantity and analysis of manure collected on Farm A.

Manure source	Weight or volume produced per year	Analysis, lb/ton or lb/1000 gal and (Quantity, tons/yr)				
		Total N	NH ₄ N	Organic N	P ₂ O ₅	K ₂ O
Bedded pack	652 tons	14 (4.6)	2 (0.7)	12 (3.9)	18 (5.9)	14 (4.6)
Lactating cows	2,100,000 gal	35 (36.8)	15 (15.7)	20 (21.0)	12 (12.6)	19 (20.0)
Heifers	360,000 gal	50 (9.0)	21 (3.8)	29 (5.2)	22 (4.0)	58 (10.4)
Dry cows	288,000 gal	34 (4.9)	18 (2.6)	16 (2.3)	12 (1.7)	46 (6.6)

Table 8. Quantity and analysis of manure collected on Farm B.

Manure source	Weight or volume produced per year	Analysis, lb/ton or lb/1000 gal and (Quantity, tons/yr)				
		Total N	NH ₄ N	Organic N	P ₂ O ₅	K ₂ O
Manure pond	5,352,000 gal	28 (74.9)	15 (40.1)	13 (34.8)	12 (32.1)	21 (56.2)
Heifers, < 6 mos.	555 tons	10 (2.8)	1 (.3)	9 (2.5)	4 (1.1)	13 (3.6)
Dry cows, bred heifers	2,109 tons	11 (11.6)	3 (3.2)	8 (8.4)	5 (5.3)	11 (11.6)

Step 3. Measure nutrient content in manure.

Representative samples of manure from each handling system were taken and analyzed on a periodic basis until reasonably consistent results were obtained (Tables 7 and 8). On Farm A, nutrient levels were highest from the heifer barn. Between 71 and 75% of the manure on the two farms was from lactating cows; thus, nutrient concentrations in this manure source were of greatest importance to the planning process.

Multiplying the quantity of manure by its respective nutrient content and summing over manure sources gave the amount of nutrients collected annually (Table 4).

Step 4. Identify cropping program.

Tables 9 and 10 give the acreages for the crops in the rotation for Farm A and B respectively. Because on Farm A, there was only 10 days of manure storage capacity in the milking barns, some idle land was set aside each summer to serve as a manure disposal area during the growing season. This practice is not recommended, and manure-storage plans were evaluated to utilize the nutrients more effectively (Part IV, Rasmussen et al.). Crop rotation and crop to be grown on each field were recorded. This information was used to prioritize fields on the basis of nutrient requirements. Records of previous manure applications to determine residual manure N would have been useful; however, this information was not complete for either farm.

Table 9. Average soil test results for different crops on Farm A.

Crop land	Land area	Soil test		
		pH	P	K
		lb/acre		
Triticale-pea/alfalfa	57	7.85	56 (VH) [†]	181 (VH)
Alfalfa, established	203	7.61	26 (H)	132 (H)
Corn	287	7.68	18 (H)	144 (H)
Grass	5	7.90	42 (VH)	260 (VH)
Idle	52	7.89	16 (H)	87 (M)
All crops [‡]	604	7.69	24 (H)	140 (H)

[†]Soil test level: M = medium, H = high, VH = very high.

[‡]Total crop land area; weighted average soil test results.

Table 10. Average soil test results for different crops on Farm B.

Crop land	Land area	Soil test		
		pH	P	K
	acres		lb/acre	
Alfalfa	393	7.71	24 (H)	141 (H)
Corn	607	7.74	22 (H)	152 (H)
Grass	78	7.81	11 (H)	131 (H)
All crops [‡]	1,078	7.73	22 (H)	147 (H)

[†]Soil test level: M = medium, H = high, VH = very high.

[‡]Total crop land area; weighted average soil test results.

Step 5. Determine risk and optimum time period for spreading manure on each field.

Each production field was assigned a risk level based on nutrient loss potential for the soil and topography, nuisance factor to neighbors, and crop quality considerations. The risk factor was used to determine the most appropriate seasonal timing of applications. A level of 1 to 4 was assigned according to percent slope, slope length, flooding frequency, drainage class, areas of concentrated runoff, winter access, and closeness to neighbors (Klausner, 1995). Risk levels were coded as follows: 1 = low risk, year round spreading acceptable; 2 = minimal risk, spreading best from April to December; 3 = moderate risk, spreading limited to April to October; 4 = high risk, no spreading at any time.

For Farm A, the majority of fields were very gently sloping with slope lengths less than 200 ft, indicating low probabilities of erosion or runoff. Soils were well or moderately-well drained and positioned on the hill top, so the risk of flooding was minimal. There was good access to most fields for winter spreading. All but a small percentage of fields were rated risk level 1 or 2. Although the farmstead was located close to a small town, less than 1% of cropped area was rated risk level 4 due to nearness to neighbors or the need to reduce K levels in forage fed to dry cows.

Step 6. Assess net nutrient requirements of each crop.

Crop nutrient recommendations were based on Cooperative Extension recommendations (Cornell, 1993). Current and previous inputs of organic N from manure were assessed for their fertilizer N equivalence using the decay rates of Klausner et al. (1994). Tables 9 and 10 show the average soil test levels for fields in each crop. Soil pH, P, and K levels were in the high to very high range. Net nutrient requirement was the total requirement minus starter fertilizer application and minus residual manure N availability (for formulating an N recommendation).

Step 7. Determine the highest priority nutrient and time of application.

The nutrient having the highest priority was N, based on the fact that N was more limiting for crop growth than P or K. Time of manure application to individual fields was prioritized based on their risk level. This identified which fields were to receive manure during different periods of the year. The timing of application was not a serious restriction for Farm A because almost all fields were rated risk level 1 or 2 (Step 5).

Step 8. Calculate desired manure application rate.

The fertilizer replacement value of manure (Klausner et al., 1994; Klausner, 1995) was used to determine the rate of manure application to individual fields based on the recommendation for the nutrient having the highest priority. The net nutrient requirement from Step 6 was divided by the fertilizer N equivalent in manure. The following equation was applied to each field: Rate of manure per acre = [Total fertilizer requirement - starter fertilizer recommendation - residual manure N]/(fertilizer N equivalent per ton or per 1000 gal manure). The fertilizer N equivalent of manure was the sum of ammoniacal N and organic N concentrations (Klausner et al., 1994; Klausner, 1995). However, most of the ammoniacal N fraction was lost by volatilization because manure was not immediately incorporated into the soil (Lauer et al., 1976). Based on mineralization rates of organic N, it was estimated that 7, 10, and 5.5 lb N would be equivalent to fertilizer N per 1000 gal of liquid manure produced in the barns housing lactating cows, heifers, and dry cows, respectively, and 4 lb N/ton from the bedded pack in the calf barn. These fertilizer N equivalents were 35% of the organic N contents in Table 7.

Step 9. Select rates of manure application.

After summing the desired manure application rates over all fields (Step 8), the quantity required was compared to the amount available. Surpluses would be divided among fields with the lowest risk of nutrient loss. However, on Farm A there was not enough manure to satisfy the net nutrient requirement for N. Because N was the highest priority, the acreages of the highest N-requiring crop (two or more years of continuous corn) were summed and divided into the quantity of manure collected. A base rate of 10,000 and 12,000 gal/acre was selected for the second and third or more years of continuous corn, respectively, assuming an available N of 7 lb/1000 gal from the lactating cows. For other manure sources, the rate of application was adjusted based on the ratio of available N, e.g. if the recommended rate was 10,000 gal/acre from the lactating cow barn, then the adjusted rate for manure from the dry cow barn was $10,000 \times (7/5.5) = 12,700$ gal/acre.

Quantity of manure applied per field was the product of the selected application rate per acre and the number of acres in the field. The N, P, and K application rate was obtained by multiplying the selected application rate per acre by the available N and total P and K per unit of manure applied.

Step 10. Determine additional fertilizer requirements.

The supplemental fertilizer requirement was the difference between the net N, P, and K requirement and the quantity of available nutrients applied in manure. For Farm A, the pre-sidedress nitrate soil test (PSNT) for corn (Magdoff et al., 1984; Klausner et al., 1993) was used extensively to verify the need for additional fertilizer N.

Tables 11 and 12 give the average manure and fertilizer applications recommended for each crop on Farm A and B. The majority of manure (75%) on Farm A was applied to corn. A small amount of manure was applied to older stands of alfalfa. Fertilizer application rates were kept to a minimum because manure nutrients substituted for much of the fertilizer requirement. Implications of the nutrient management plan's impact on the mass nutrient balance are considered in Hutson et al. (Part III); economic costs and benefits of implementing these plans are presented in Rasmussen et al. (Part IV)

Table 11. Recommended average fertilizer and manure application rates in the nutrient management plan for Farm A.

Crop land	N	P ₂ O ₅	K ₂ O	Manure	
				total	per area
		lb/acre		1000 gal	1000 gal/acre
Triticale-peas/alfalfa	40	20	20	0	0
Alfalfa, established	0	8	30	140	0.7
Corn [†]	38	22	21	2370	8.2
Grass	160	0	0	0 [‡]	0
Idle	0	0	0	2	12.0
All crops [§]	23.4	15.0	21.8	3120	5.2

[†] Manure was not applied to first-year corn following alfalfa.

[‡] No manure was applied to grass because of need for low-K grass hay for dry cows.

[§] Average application rates of N, P₂O₅, K₂O, and manure; sum of total manure applied to all crop land.

Table 12. Recommended average fertilizer and manure application rates in the nutrient management plan for Farm B.

Crop land	N	P ₂ O ₅	K ₂ O	Manure	
				total	per area
		lb/acre		1000 gal	1000 gal/acre
Alfalfa	6	25	20	210	0.5
Corn [†]	50	18	18	5712	9.2
Grass	122	0	0	840	14.0
All crops [‡]	37.7	19.4	17.8	6762	6.3

[†] Manure was not applied to first-year corn following alfalfa.

[‡] Average application rates of N, P₂O₅, K₂O, and manure; sum of total manure applied to all crop land.

CONCLUSIONS

Mass nutrient balances for Farms A and B indicated that 60 to 85% of input N, P, and K were retained on the farm; 40 to 80% of imported nutrients were from purchased feeds. Critical evaluation and refinement of the rations on Farm A effected a reduction in crude protein content of 2 percentage points while supporting a 13% increase in milk production. Reductions were achieved by closely balancing the nutrient supply and requirements of rumen bacteria and the whole animal, allowing greater usage of farm produced feeds. Nutrient excretion in manure decreased by 30 to 40% during the ration adjustment period. With nutrient management planning, manure substituted for much of the fertilizer requirement. Soil testing, manure analyses, feed analyses, and monitoring of animal dry matter intake were among the critically important tools in soil, crop, and animal nutrient management.

REFERENCES

- ASAE. 1995. Manure production and characteristics. p.484-486 . *In* ASAE Standards. ASAE, St. Joseph, MI.
- Cornell. 1993. Cornell recommends for integrated field crop management. Dept. Soil, Crop, and Atmos. Sci., Cornell Univ., Ithaca, NY.
- Fox, D. G., M. C. Barry, R. E. Pitt, D. K. Roseler, W. C. Stone. 1995. Application of the Cornell net carbohydrate and protein model for cattle consuming forages. *J. Anim. Sci.* 73:267-277.
- Heichel, G. H., D. K. Barnes, and C. P. Vance. 1981. Nitrogen fixation of alfalfa in the seeding year. *Crop Sci.* 21:330-335.
- Heichel, G. H., D. K. Barnes, C. P. Vance, and K. I. Henjum. 1984. N fixation and nitrogen and dry matter partitioning during a four year alfalfa stand. *Crop Sci.* 24:811-815.
- Hutson, J. L., R. K. Koelsch, R. E. Pitt, and R. J. Wagenet. 1996. Integrating knowledge to improve dairy farm sustainability III: Environmental losses and nutrient flows. (submitted).
- Klausner, S. D. 1995. Nutrient management: Crop production and water quality. Cornell Univ. Publication Services, Research Park, Ithaca, NY.
- Klausner, S. D. 1993. Mass nutrient balances on dairy farms. p. 126-129. *In: Proc. Cornell Nutrition Conf. Feed Manuf.* Cornell Univ., Ithaca, NY.
- Klausner, S. D., W. S. Reid, and D. R. Bouldin. 1993. Relationship between last spring soil nitrate concentrations and corn yields in New York. *J. Prod. Agric.* 6:350-354.
- Klausner, S. D., V. R. Kanneganti, and D. R. Bouldin. 1994. An approach for estimating a decay series for organic nitrogen in animal manure. *Agron. J.* 86:897-903.
- Lanyon, L. E. 1994. Dairy manure and plant nutrient management issues affecting water quality and the dairy industry. *J. Dairy Sci.* 77:1999-2007.
- Lauer, D. A., D. R. Bouldin, and S. D. Klausner. 1976. Ammonia volatilization from dairy manure spread on the soil surface. *J. Environ. Qual.* 5:134-141.
- Magdoff, F. R., D. Ross, and J. Amadon. 1984. A soil test for nitrogen availability to corn. *Soil Sci. Soc. Am. J.* 48:1301-1304.

- Nour, A. Y. M., and M. L. Thonney. 1988. Minerals of carcass soft tissue and bone of serially slaughtered cattle as affected by biological type and management. *J. Agric. Sci., Camb.* 111:41-49.
- Pell, A. N. 1992. Does ration balancing affect nutrient management? p. 23-31. *In: Proc. Cornell Nutrition Conf. Feed Manuf. Cornell Univ., Ithaca, NY.*
- Rasmussen, C.N., J.J. Hanchar, and P.E. Wright. 1996. Integrating knowledge to improve dairy farm sustainability IV: economic evaluation of alternatives to improve nutrient efficiency. (submitted).
- Tamminga, S. 1992. Nutrition management of dairy cows as a contribution to pollution control. *J. Dairy Sci.* 75:345-358.

Integrating Knowledge to Improve Dairy Farm Sustainability - Part III:

Environmental Losses and Nutrient Flows

J. L. Hutson, R. K. Koelsch, R. E. Pitt, and R. J. Wagenet.

ABSTRACT

In Part II of this study (Klausner et al., 1996), it was shown that 60 to 85% of the nutrient inputs for the two case study farms were not accounted for in the measured outputs. The purpose of this part of the study was to quantify the environmental losses of N from manure storage and from volatilization, denitrification, and leaching from the fields. Manure composition was determined at excretion, before storage, and after storage. Losses of N through volatilization on the barn floor and in storage were estimated with the model of Muck and Steenhuis (1981). Barn floor losses were highly dependent on scraping interval and temperature. Total loss of N from manure was 16% of excreted N on Farm A and 19% on Farm B. Leaching losses in the fields were estimated using the LEACHN model of Hutson and Wagenet (1991), and accounted for 9% and 8 % of total N inflows to Farm A and Farm B, respectively. The majority of the leaching losses were from the best drained soils. For example, on farm A, about 70% of the leaching losses were concentrated on 25% of the land area, and were associated with the most well drained soils. Total environmental losses accounted for between 75% and 68 % of the retained N on the two farms. Implementation of the crop nutrient management plan of Part II (Klausner et al., 1996) is predicted to reduce the net excess of P and K on Farm A and N, P and K on Farm B. .

INTRODUCTION

Results of the mass nutrient balances for Farms A and B in Part II of this study (Klausner et al.) indicated respectively that 72% and 76 % of the N, 57% and 75 % of the P, and 71% and 85% of the K imported as feed, fertilizer, and N fixation were not accounted for in the export of nutrients as milk and animals. These retained nutrients can accumulate on the farms or escape into the water and air. To determine the fate of these nutrients, losses of nutrients at various points in the farm have to be estimated.

The crop nutrient management plans developed in Part II maximized the use of manure nutrients as a replacement for chemical fertilizers. Implementation of the plans is expected to affect mass nutrient balances and loss of nutrients to the environment. The objectives of this part of the study were to quantify the losses of N in manure handling between excretion and application of manure to the fields, estimate the losses of N by leaching and volatilization/denitrification in the fields, and synthesize nutrient flow information to determine the extent to which environmental losses account for retained nutrients.

MATERIALS AND METHODS

To determine N losses from manure, characteristics of manure were determined on three data collection visits to Farm A (June 23, August 12, and October 25, 1994) and three data collection visits to Farm B (July 5, August 12 and October 18, 1994). Samples were taken at excretion, after residence on the barn floor, and after storage. At excretion, manure was collected by scraping sections of the alley approximately 8 feet in length. The alley was first cleaned, and after 30 minutes the total manure was removed and sampled. Recovery of the urine fraction was difficult with this method, so for subsequent samplings, urine and feces from at least 5 animals were collected separately prior to falling on the floor. The balance between urine and feces was

estimated from Morse et al. (1994) and ASAE (1992): 38.5% of manure was assumed to derive from urine, 61.5% from feces. Manure was analyzed by the Northeast Dairy Herd Improvement Association for total solids, total N, ammonia N, urea N, organic N, P, K, and pH.

The mathematical models of Muck and Steenhuis (1981) and Muck and Steenhuis (1982) were implemented to predict N losses from the barn floor and manure storage, respectively. The first model simulates the conversion of urea to ammonia and the volatilization of ammonia. Urea conversion is assumed to follow a Michaelis-Menten relationship with urea as the substrate. The maximum conversion rate is an Arrhenius function of temperature. Volatilization rate is dependent on temperature, current ammonia concentration, pH, wind speed, and surface to volume ratio (inverse of depth). Barn temperatures were recorded for a period of 6 months at various elevations in the barn, and were found to remain within 4°F of the ambient temperatures recorded at a near-by weather station. Thus, weather station temperatures were used with the exception that temperatures at the floor of the barn were assumed to remain above freezing. For outdoor manure storage, wind speed was taken as 50% of the value at the weather station; indoor wind speed was assumed to be 0.7 mph.

To estimate N losses from the fields, transformations, volatilization, denitrification, and leaching of N from the soils were simulated using the LEACHN model of Hutson and Wagenet (1991, 1992). LEACHN considers water movement (Richards equation) and chemical transport (convective-dispersive equation) through a soil matrix. Because over 95% of the land area had slopes less than 8%, and slopes were generally less than 3%, the hydrology was simplified to include only vertical flow and evapotranspiration, with no runoff or subsurface lateral flow. Soil type information was obtained from Soil Survey (1971) data, which were used to estimate both water retention and conductivity. Lower boundary conductivities were chosen using values established in a previous project (Hutson et al., 1988), so that water table fluctuations were typical of those measured in the region by Fritton and Olson (1972).

Transformations of N between plant residue, manure, other organic matter, ammonia, urea, and nitrate, as well as adsorption, were simulated in LEACHN as described in Hutson and Wagenet (1991). The soil was divided into 10 segments, each 4 inches in depth. Volatilization from the soil surface segment was modeled as a first order process. Denitrification was assumed to follow a Michaelis-Menten relationship with nitrate as the substrate. Both volatilization and denitrification are dependent on temperature and soil moisture content; denitrification increases as the soil approaches saturation. Mineralization rate coefficients were chosen to coincide with the organic N decay rates of Klausner et al. (1996). Unadjusted N transformation rate constants were similar for all soils; differences arose in response to differences in profile water content and temperature regimes.

Uptake of N by alfalfa was estimated from the typical N content of harvested alfalfa (3.2%), from the percentage of uptake N that goes to harvested N (33% for year 1, 20% for subsequent years), and from typical dry matter yields (7,600 lb/(acre•yr)). Uptake N was supplied by soil mineral N if available; the balance of the N uptake was assumed to be met by N fixation.

The LEACHN simulations were coupled to a raster-based GIS system (IDRISI) with 164 by 164 ft pixels. LEACHN simulations were performed for each pixel. Information from soil survey maps was digitized into the GIS format. A variety of soil types with widely varying drainage classes were present in cultivated fields. Information on cropping patterns for each field for the previous three years (1992 to 1994) and the following year (1995) were obtained from the

nutrient management plan. Accurate manure application history was not available, so the manure and fertilizer application rates were assumed to be those of the nutrient management plan. LEACHN simulated N dynamics for each soil/crop/nutrient combination with weekly output.

Nutrient flow information for crops, soils, feeding, and manure on the farms was synthesized using the constructs of Bacon et al. (1990) and Saama et al. (1994). For each farm, mass balances were performed on the whole farm and on subunits of the farm, wherein the difference between inflows and outflows equaled the rate of accumulation (or depletion) within each subunit. Subunits of animal housing (not including barn floor losses), manure storage (including barn floor losses), and all fields combined were analyzed. Figure 1 shows the flows and groupings; each box is a unit or subunit, and arrows show the mass flows crossing the boundaries. In some cases, an outflow from one subunit was an inflow to another subunit (e.g. manure out of the barns and into storage). Also, some flows crossed both the whole farm boundary and a subunit boundary (e.g. purchased feeds). The mass balances depicted in Figure 1 were performed separately for N, P, and K, but not all flows in Figure 1 were present for P and K.

Flows of purchased feeds and crops were evaluated from rations for early 1995. Ration information included dry matter intake; distribution of feeds in the ration; N and P concentrations in forages and concentrates; N, P, and K concentrations in the overall ration; body weight; and milk production. Reference values for K concentrations in the crops and feeds were used (National Research Council, 1988). Dry matter intake for each group of lactating cows was available for the previous 12 months, from which an annual average was calculated. Crop nutrient flows from the fields were obtained from yields measured by the farmer for the 1994 growing season on a field-by-field basis using weigh scales.

RESULTS AND DISCUSSION

Nitrogen Losses from Manure

Table 1 gives the measured manure-N concentrations at excretion for lactating cows on Farm A. The June 23 sampling, consisting of collection from the barn floor after a 30 minute interval, resulted in total solids, total N, and urea concentrations similar to the fecal samples in the two later assessments. This is consistent with a lack of recovery of the urine fraction in the first sampling. The August and October assessments differed substantially in total N, ammonia, and urea, but P and K concentrations were fairly stable.

Total N concentrations after retention on the barn floor before storage were also highly variable among the three samplings (Table 2). For the June 23 sample, N concentration was higher than at excretion, which shows the inaccuracy of the excretion measurement. Reduction in N concentration was approximately 40% for August 12 and 14% for October 25, but these values depended on the assumption of urine/feces ratio. Urea accounted for between 20 and 50% of the total N in the urine at excretion (Table 1), but this was reduced to zero after retention on the barn floor, so that all the N was organic N and ammonia. This suggests a rapid transformation of urea to ammonia.

Figure 1. Definition of farm subunits (boxes), and nutrient flows across the boundaries of these subunits (arrows).

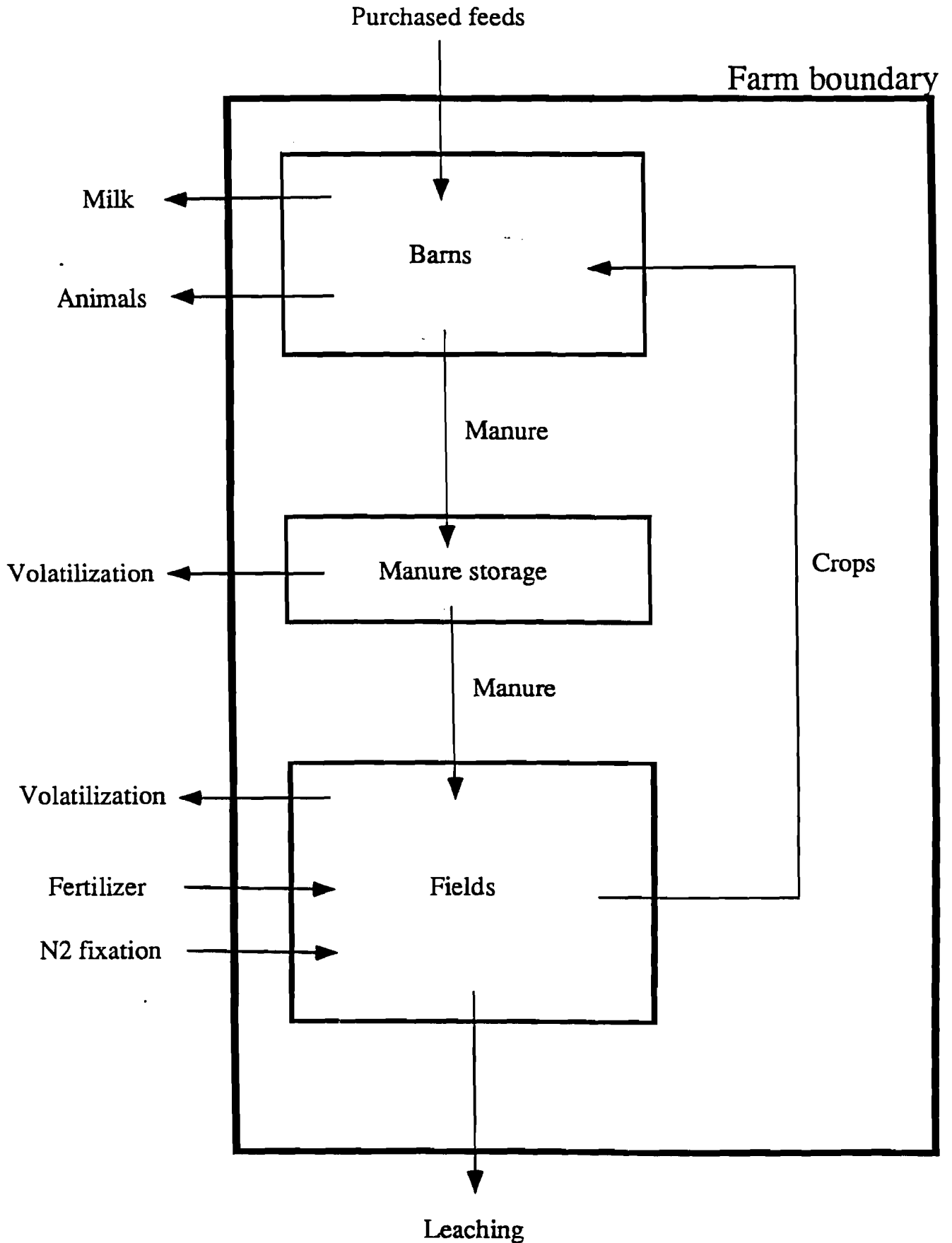

Table 1. Nutrient contents (% of wet mass) of milking-herd manure at excretion, measured at three sampling dates on Farm A.

Nutrient	Sampling Date						
	June 23 Combined	August 12			October 28		
		Urine	Feces	Combined†	Urine	Feces	Combined†
Total solids	11.1	---	10.9	6.7	---	7.6	4.5
Total N	0.41	1.28	0.57	0.84	1.07	0.41	0.66
Ammonia	0.096	0.690	0.025	0.281	0.025	0.022	0.023
Urea	0.004	0.270	0.003	0.106	0.527	0	0.203
Organic N	0.307	0.320	0.538	0.454	0.519	0.387	0.438
P	0.114	0.030	0.121	0.086	0.010	0.128	0.083
K	0.176	0.690	0.078	0.314	0.650	0.077	0.298
pH	7.1	8.3	6.8	7.38	7.9	---	---

†Assuming 38.5% urine, 61.5% feces.

Table 2. Measured nutrient contents (% of wet mass) of lactating cow manure just prior to storage on Farm A.

Nutrient	Sampling Date		
	June 23	August 12	October 25
Total solids	8.9	9.4	7.5
Total N	0.57	0.49	0.57
Ammonia	0.31	0.21	0.25
Urea	0.001	0	0
Organic N	0.25	0.28	0.32
P	0.090	0.099	0.099
K	0.36	0.30	0.36
pH	7.8	7.4	---

After storage (Table 3), total N and ammonia concentrations were lower than just prior to storage (Table 2). P and K concentrations were also lower. However, the manure sampled after storage was not the same manure sampled prior to storage, so a direct comparison could not be made.

Total solids content of manure averaged 8.6% prior to storage (Table 2) and 6.7% after storage (Table 3). This apparent decrease reflects the addition of dilution water from milking center waste and clean water for producing a more easily pumped slurry. These additions were estimated to be 37,400 lb water/day, and accounted for 40 to 50% of the liquid volume being hauled from storage.

Table 3. Measured nutrient contents (% of wet mass) of milking-herd manure after storage on Farm A.

Nutrient	Sampling Date		
	June 23	October 25	November 23
Total solids	10.7	4.3	5.2
Total N	0.42	0.26	0.44
Ammonia N	0.16	0.12	0.17
Urea N	0	0.003	0
Organic N	0.26	0.14	0.27
P	0.060	0.061	0.071
K	0.19	0.12	0.24
pH	---	7.1	---

Results of the manure analysis showed the difficulty of determining N losses by sampling manure. Sampling of mixed urine and feces apparently biased the composition toward higher feces than urine. Separate sampling of urine and feces required an assumption of urine/feces ratio. Also, tracking changes in manure through storage was problematic. For these reasons, the models of Muck and Steenhuis (1981, 1982) were implemented to estimate N losses at these points in the waste stream. Efforts to duplicate the results in Muck and Steenhuis (1981) for checking the computer program revealed two challenges. First, it was implicitly assumed in Muck and Steenhuis (1981) that manure and urine were not mixed on the barn floor, but that the characteristics of the urine alone dictated the conditions for urea conversion and ammonia volatilization. Given that volatilization rate increases with pH, and that the pH of urine is higher than that of total manure (Table 1), this assumption increased N losses. Secondly, the surface to volume ratio (A) for manure on the floor was not provided by Muck and Steenhuis (1981). For this, a urine depth of 0.04 inches was assumed (for which A is 25 inches⁻¹) until the floor area

was covered, after which depth was increased uniformly until the next scraping. Larger values of A (smaller depths) enhanced volatilization substantially, so this assumption was important to the end predictions. With these assumptions, the results of Muck and Steenhuis (1981) could be reasonably duplicated.

Efforts to duplicate the storage-loss simulations of Muck and Steenhuis (1982) were less successful. Lacking the ability to implement the storage-loss model, the model for barn floor losses was adapted to top loaded manure storage losses, assuming that all urea had previously been converted to ammonia. Diffusion of ammonia to the surface of the storage should not have been rate limiting, because the manure highest in ammonia was being applied to the surface, and losses should have been dictated by the volatilization rate. The surface area of storage was 2,580 ft² on Farm A.

Figure 2 shows the predicted N losses from the barn floor as a function of scraping interval and temperature. Losses increased with scraping interval up to 40 hours and were highly temperature dependent. Thus, predicted losses varied with time of year, and most losses occurred between April and October. Table 4 gives the manure production, scraping interval, and N losses for each barn and for manure storage. Manure production was estimated from ASAE (1992) equations. In Part II (Klausner et al., 1996), total manure production was estimated to be 23 million lb. per year, based on the number of spreader loads collected per month and spreader capacity. This value is within 3% of the manure production estimate in Table 4. The losses of N from the dry cow, heifer, and calf barns were much greater than for the lactating cow barn because of the much longer scraping interval (3.5 days versus 40 minutes). Overall N loss for all manure handling and storage averaged for an entire year was 16% of excreted N (Table 4).

Table 4. Manure production and predicted volatilization losses of N on the barn floor and in storage on Farm A.

Location	Manure Production (lb/day)	Scraping Interval (hours)	N Loss (% of excretion)
Lactating cow barn	48,900	0.67	0
Dry cow barn	6,600	84	17
Heifer barn	9,000	84	19
Calf barn	900	84	29
Storage			15
Overall	65,400		16

Figure 2. Predicted volatilization losses of N from the barn floor as dependent on scraping interval and temperature. Curve labeled "average" shows N losses for a whole year using monthly average temperatures.

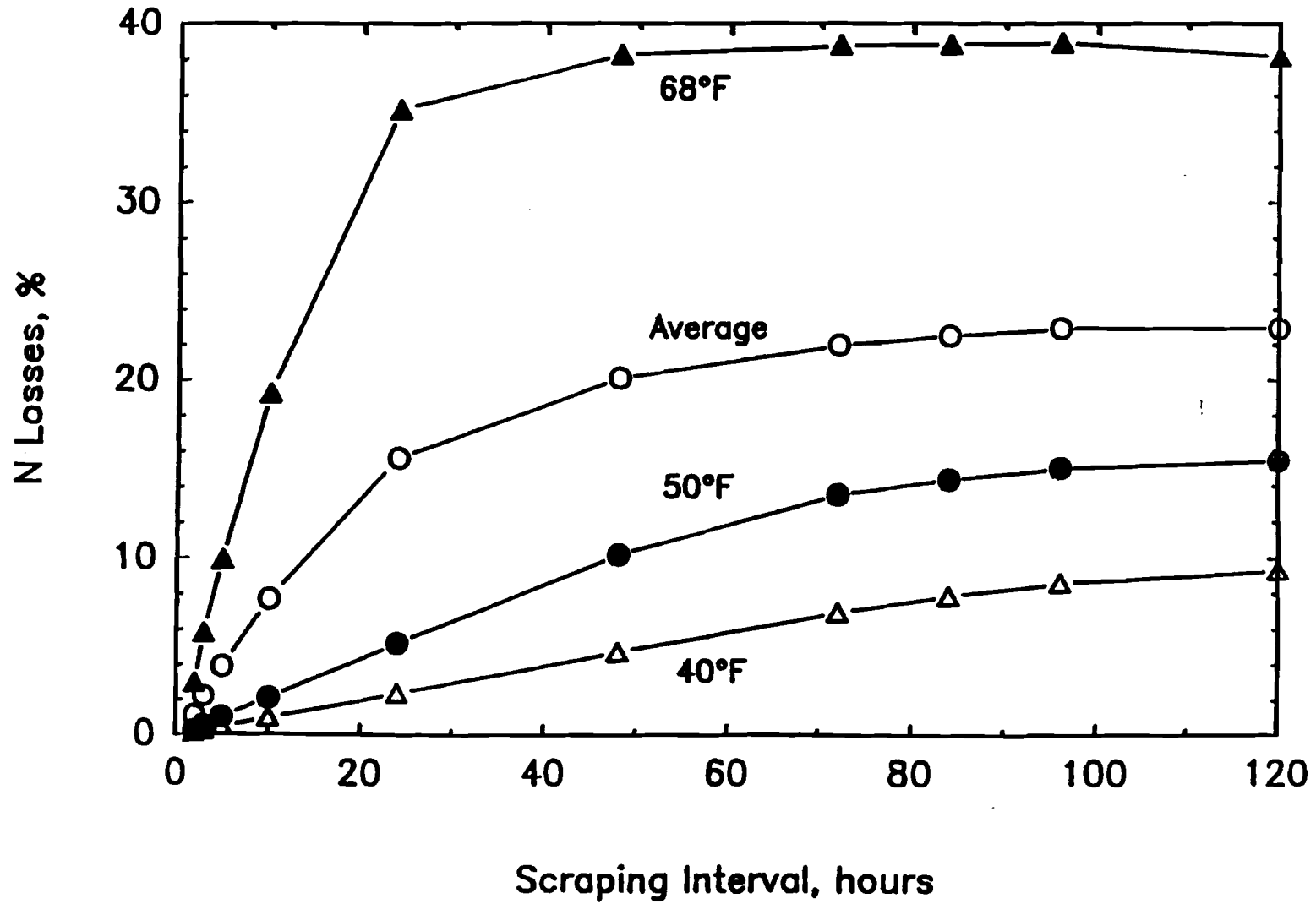

Table 7. Characteristics and contribution to N leaching of the various soil types on Farm B.

Series	Texture	Slope	Area (% of total)	Contribution to N leaching (% of total)	(% Leaching) (% Area)
Kendaia	Silt loam	0-3	7.7	0.4	0.05
Lima	Silt loam	3-8	12.6	1.5	0.12
Lima	Silt loam	0-3	32.2	6.8	0.21
Honeoye	Silt loam	2-8	45.6	91.0	2.00
Arkport	Fine sandy loam	1-6	0.6	0.1	0.19
Honeoye/Lansing	Gravelly silt loam	14-20	0.4	0.1	0.23
Palmyra	Gravelly loam	3-8	0.5	0.1	0.17

Table 8. Grouping of soils into four drainage classes and the contribution to leaching of each class as affected by crop type on Farm A.

Class	Drainage (inches/year)	Area		N Leached		Crop	N Leached (lb/(acre•year))
		acres	% of total	lb/year	% of total		
1	2.4-2.6	156	24.1	450	3.6	Alfalfa	2.9
						Corn	2.7
						Grass	2.3
						Idle	4.6
2	5.4-5.9	277	43.0	2,040	16.6	Alfalfa	7.0
						Corn	7.7
						Grass	7.1
						Idle	11.0
3	14.7-15.4	163	25.0	8,500	68.9	Alfalfa	41.2
						Corn	65.5
4	16.1-16.5	47	7.5	1,340	10.9	Alfalfa	20.2
						Corn	33.4

Drainage was the most important variable dictating leaching in these simulations, and was determined by the assigned conductivity at the lower boundary of the profile. Lower drainage impacted N leaching in two ways: through reduced drainage fluxes from the bottom of the profile, and through lower N concentrations in the leachate, since wetter soils promote denitrification. Surface runoff, lateral subsurface drainage and proximity to streams, none of which were included in the simulations, may nonetheless lead to low-drainage soils being potential sources of pollution.

Strategies to control leaching from well drained soils have not been identified. Replacing alfalfa with grass may or may not be a reasonable strategy, because leaching of N from the few grass fields was comparable to that from other crops on the same soil (Table 8). Moreover, management by soil type would require redefining field boundaries, a scheme that may not be feasible on the case farms.

Synthesis of Nutrient Flow Information

Whole farm and subunit N flows are shown in Tables 9 and 10. Each column gives the estimated inflows (positive) and outflows (negative) for the unit or subunit identified in the column heading; flows are labeled in the first column. At the bottom of each column is the sum of the flows for that column, and represents net excess (or depletion) of N in that subunit. Dividing the net excess by the sum of the inflows for that subunit gave the excess as a percentage of inflows. For example, the first column of numbers represents the whole farm N balance as presented in Part II (Klausner et al., 1996), and includes only those flows which cross the farm boundary, i.e. inputs of purchased feeds, fertilizer, and N fixation, and outputs of milk and animals (Figure 1). On Farm A, net excess of N was 103,400 lb/year, representing 72% of N inflows for the whole farm. On Farm B, net excess of N was 180,400 lb/year, representing 76% of N inflows for the whole farm.

The second column of numbers in Tables 9 and 10 gives the N flows for the barns subunit. Flows crossing the boundary were inflows of purchased feeds and crops, and outflows of milk, animals, and manure (Figure 1). Purchased-feed input for the whole farm (first column) carried over to the barns subunit, assuming that all the purchased feeds brought onto the farm in that year passed into the barn. Similarly, outflows of milk and animals carried over from the first column. Crops input to the barns was obtained from ration information (sum of high moisture ear corn, alfalfa silage, and corn silage). Manure outflow from the barns represented only excretion and did not include volatilization losses from the barn floor or storage.

On both farms, net excess of N in the barns subunit was small, 5% and 1 % of the N inflows to the barns subunit for Farm A and B respectively. This is reasonable because there is no obvious accumulation of N in the barns. In the third column of numbers in Tables 9 and 10, N flows associated with the manure storage subunit are shown. The flows were manure N excretion, manure N outflow to the fields, and volatilization losses. Volatilization included barn floor and storage losses, previously estimated to be 16% of excreted N for the overall farm on Farm A (Table 4). Calculations were performed starting with the manure N flow to the fields estimated by Klausner et al. (1996) and using the N loss estimate to back calculate N excretion. On Farm A, manure N flow to the fields was 110,600 lb/year (Klausner et al., 1996), with an average N content of 0.52%. This N content reflects the 16% loss estimated to occur in storage. Thus, dividing this flow by the fraction retained in storage (0.84 i.e. [1-0.16]) yielded the excretion N shown in Table 9. Dividing excretion N by total manure production gave an average manure-N

concentration of 0.60% at excretion. This value is in the middle of the range of measured N concentrations at excretion, 0.41 to 0.84% (Table 1).

The N flows for the fields subunit, shown in the fourth column of numbers in Tables 9 and 10, were inflows of fertilizer, manure, and N fixation, and outflows of crops and environmental losses. Crops outflow was determined from crop yield and composition data. Net excess of N in the fields subunit was negative on Farm A because outflows exceeded inflows. Negative excess could indicate depletion of soil organic N. However, on Farm A, net excess was only 9% of total inflows to the fields subunit, indicating that N depletion was small or nonexistent. Crop yields were unusually high in the study year (1994). Comparison of the crops N outflow from the fields (fourth column) with the crops N inflow to the barns (second column) showed that crop production was 33% larger than N consumption on an annual basis. Based on this, Farm A would have residual feeds at the end of the year. Farm B had a net excess for N from the fields subunit of 59,210 lbs./year.

In the last column of Tables 9 and 10, a revised whole-farm N balance was projected for the next year. Here, annual flow of N in purchased feeds was estimated from updated rations at the end of 1994, and milk N outflow was based on milk production. Fertilizer N was determined from Klausner et al. (1996), and N fixation was based on legume crop area planned for 1995. On Farm A, net balance of N was virtually unchanged from 1994, with net excess still being 70% of N inflows. Fertilizer N was projected to fall by 50% using the nutrient management plan. However, purchased feed N was apparently increased by about 20%, more than offsetting the reduction in fertilizer N and increased milk outflow. This reflected a change in the type of feeds purchased, rather than a decrease in forage:concentrate ratio. On Farm B, the percentage of N retained is projected to decrease from 76% to 65%. The major factors in the change are an increase in milk production and decrease in fertilizer use.

The modeled losses of N to the environment were volatilization from manure storage, leaching, and volatilization and denitrification from the fields. On Farm A, the sum of these losses, 78,800 lb N/year, represented over 75% of the retained N for the whole farm. On Farm B, the manure storage, leaching, and volatilization and denitrification losses are estimated at 120,960 lbs N/year, or about 67% of the retained N for the whole farm. Thus, most of the retained N, i.e. the surplus between inputs and products sold, was projected to escape into the off-farm environment. On Farm A, leached N represented about 10% of the retained N on the farm, 9% of all N inflows, and 7% of N inflows to the fields. Values were similar for Farm B with leached N being 10% of total retained N, 8 % of all N inflows and 7 % of N inflows to the field subunit.

Table 9. Flows of N (lb/year) into (+) and out of (-) the whole farm and subunits of Farm A. Each column shows the mass flowrates crossing the boundary of the unit identified in the column heading (see Figure 1).

Type of Flow	Whole Farm Unit	Barns Subunit	Manure Storage Subunit	Fields Subunit	Whole Farm Unit (1995)
Purchased feeds	+87,700	+87,700	---†	---	+106,600
Milk	-37,200	-37,200	---	---	-42,700
Animals	-3,500	-3,500	---	---	-3,500
Fertilizer	+27,100	---	---	+27,100	+13,900
Manure	---	-131,500	+131,500 -110,600	+110,600	---
Crops	---	+92,700	---	-123,800	---
Leaching	---	---	---	-12,300	---
Volatilization/ denitrification	---	---	-20,900	-45,600	---
N fixation	+29,300	---	---	+29,300	+30,400
Net excess‡	+103,400	+8,200	0	-14,700	+104,700
Net excess as percentage of inflows§	72%	5%		9%	69%

† Dashed lines indicate flows of this type do not cross the boundary of this unit or subunit.

‡ Net excess = sum of inflows and outflows for that unit or subunit.

§ Net excess as percentage of inflows = $100 \times (\text{net excess}) \div (\text{sum of inflows for that unit or subunit})$.

Table 10. Flows of N (lb/year) into (+) and out of (-) the whole farm and subunits of Farm B. Each column shows the mass flowrates crossing the boundary of the unit identified in the column heading (see Figure 1).

Type of Flow	Whole Farm Unit	Barns Subunit	Manure Storage Subunit	Fields Subunit	Whole Farm Unit (1995)
Purchased feeds	+157,000	+157,000	---†	---	+170,410
Milk	-52,800	-52,800	---	---	-80,500
Animals	-3,800	-3,800	---	---	-3,800
Fertilizer	+52,200	---	---	+52,200	+40,450
Manure	---	-242,490	+242,490 -196,010	+196,010	---
Crops	---	+144,330	---	-142,320	---
Leaching	---	---	---	-18,880	---
Volatilization/ denitrification	---	---	-46,480	-55,600	---
N fixation	+29,800	---	---	+27,800	+32,000
Net excess‡	180,400	2,240	0	59,210	158,560
Net excess as percentage of inflows§	76%	1%	---	21%	65%

†Dashed lines indicate flows of this type do not cross the boundary of this unit or subunit.

‡Net excess = sum of inflows and outflows for that unit or subunit.

§Net excess as percentage of inflows = $100 \times (\text{net excess}) \div (\text{sum of inflows for that unit or subunit})$.

Tables 11 and 12 shows similar balances for P. On Farm A, overall net excess P was 57% of inflows. Net excess was low (14%) in the barns subunit but substantial (35%) in the fields subunit. The retained P in the fields could accumulate in the soil or be lost through runoff and erosion. About 65% of the retained P for the whole farm was associated with excess in the fields. The pattern of P excess was similar on Farm B. The overall excess of P was 75% of inflows with the majority of the excess (84%) in the fields subunit.

The whole farm P balance on Farm A projected for the following year predicted a moderate decrease in P excess (Table 11). Fertilizer P usage dictated by the nutrient management plan was essentially unchanged from 1994, indicating that P fertilizer had not been over-utilized. Instead, a moderate decrease in P inflows from purchased feeds was predicted from ration information. Divergent changes in the inflows of N and P in purchased feeds reflected a change in the types of feeds being purchased. Similarly, the P balance on the fields subunit showed no projected change, again because of the closeness between actual and recommended fertilizer P usage.

The projected decrease in excess P retained on Farm B was approximately 13,000 lb/year. The majority of this projected decrease, 10,850 lbs/ year, would be in the fields subunit. This savings is due primarily to decreased use of commercial fertilizer as recommended by the NMP.

Table 11. Flows of P (lb/year) into (+) and out of (-) the whole farm and subunits of Farm A. Each column shows the mass flowrates crossing the boundary of the unit identified in the column heading (see Figure 1).

Type of Flow	Whole Farm Unit	Barns Subunit	Fields Subunit	Whole Farm Unit (1995)	Fields Subunit (1995)
Purchased feeds	+16,700	+16,700	--- [†]	+15,600	---
Milk	-7,700	-7,700	---	-8,600	---
Animals	-1,100	-1,100	---	-1,100	---
Fertilizer	+4,000	---	+4,000	+4,000	+4,000
Manure	---	-18,300	+18,300	---	+18,300
Crops	---	+14,800	-14,500	---	-14,500
Net excess [‡]	+11,900	+4,400	+7,800	+9,900	+7,800
Net excess as percentage of inflows [§]	57%	14%	35%	51%	35%

[†]Dashed lines indicate flows of this type do not cross the boundary of this unit or subunit.

[‡]Net excess = sum of inflows and outflows for that unit or subunit.

[§]Net excess as percentage of inflows = $100 \times (\text{net excess}) \div (\text{sum of inflows for that unit or subunit})$.

Table 12. Flows of P (lb/year) into (+) and out of (-) the whole farm and subunits of Farm B. Each column shows the mass flowrates crossing the boundary of the unit identified in the column heading (see Figure 1).

Type of Flow	Whole Farm Unit	Barns Subunit	Fields Subunit	Whole Farm Unit 1995	Fields Subunit (1995)
Purchased feeds	+28,400	+31,560	---†	+31,560	---
Milk	-11,000	-11,000	---	-16,100	---
Animals	-1,000	-1,000	---	-1,000	---
Fertilizer	+20,000	---	+20,000	+9,150	+9,150
Manure	---	-33,620	+33,620	---	+33,620
Crops	---	+21,380	-22,990	---	-22,990
Net excess ‡	36,400	7,320	30,630	23,610	19,780
Net excess as percentage of inflows§	75%	14%	57%	58%	46%

† Dashed lines indicate flows of this type do not cross the boundary of this unit or subunit.

‡ Net excess = sum of inflows and outflows for that unit or subunit.

§ Net excess as percentage of inflows = $100 \times (\text{net excess}) \div (\text{sum of inflows for that unit or subunit})$.

Tables 13 and 14 show the flows for K on the two case study farms. On Farm A, apparent excess of K in the barns subunit represented 26% of inflows. For the fields subunit there was a substantial depletion of K primarily because of the large outflow with crop yields. Fertilizer K usage with the nutrient management plan (fourth column) was projected to decrease 30% from the study year. Also, K inflows with purchased feeds were smaller by 60%. These changes projected a reduction in retained K on the farm and a greater depletion of K from the fields.

On Farm B, 85 % of inflows of K are unaccounted for by off farm exports of milk and animals. The greatest share of K inflows was to the fields subunit. Utilizing the NMP is projected to decrease the K flow imbalance appreciably due to a 28 ton decrease in K applied as fertilizer.

Table 13. Flows of K (lb/year) into (+) and out of (-) the whole farm and subunits of Farm A. Each column shows the mass flowrates crossing the boundary of the unit identified in the column heading (see Figure 1).

Type of Flow	Whole Farm Unit	Barns Subunit	Fields Subunit	Whole Farm Unit (1995)	Fields Subunit (1995)
Purchased feeds	+24,700	+24,700	--- [†]	+9,500	---
Milk	-11,200	-11,200	---	-12,800	---
Animals	-200	-200	---	-200	---
Fertilizer	+14,500	---	+14,500	+10,600	+10,600
Manure	---	-68,900	+68,900	---	+68,900
Crops	---	+84,600	-104,200	---	-104,200
Net excess [‡]	+27,800	+29,000	-20,800	+7,100	-24,700
Net excess as percentage of inflows [§]	71%	26%	25%	35%	31%

[†]Dashed lines indicate flows of this type do not cross the boundary of this unit or subunit.

[‡]Net excess = sum of inflows and outflows for that unit or subunit.

[§]Net excess as percentage of inflows = $100 \times (\text{net excess}) \div (\text{sum of inflows for that unit or subunit})$.

Table 14. Flows of K (lb/year) into (+) and out of (-) the whole farm and subunits of Farm B. Each column shows the mass flowrates crossing the boundary of the unit identified in the column heading (see Figure 1).

Type of Flow	Whole Farm Unit	Barns Subunit	Fields Subunit	Whole Farm Unit (1995)	Fields Subunit (1995)
Purchased feeds	+45,600	+40,700	--- [†]	+40,700	---
Milk	-16,600	-24,140	---	-24,140	---
Animals	-200	-200	---	-200	---
Fertilizer	+70,200	---	+70,200	+14,480	+14,480
Manure	---	-111,550	+111,550	---	+111,550
Crops	---	+127,390	-132,400	---	-132,400
Net excess [‡]	99,000	32,200	49,350	30,840	-6,370
Net excess as percentage of inflows [§]	85%	19%	27%	56%	5%

[†]Dashed lines indicate flows of this type do not cross the boundary of this unit or subunit.

[‡]Net excess = sum of inflows and outflows for that unit or subunit.

[§]Net excess as percentage of inflows = $100 \times (\text{net excess}) \div (\text{sum of inflows for that unit or subunit})$.

IMPLICATIONS

Atmospheric and water-borne losses of N to the environment may be viewed in different ways. If water quality were the sole concern, then atmospheric losses would be considered benign or even advantageous. Less land area is required when rates of manure application are N based, permitting a higher application of manure to fields closest to the barns thereby reducing application costs. Viewing atmospheric losses as benign suggests that existing practices such as long manure scraping intervals and surface application of manure to the fields were acceptable. On the other hand, atmospheric losses of N could be a problem for the case study farms. Atmospheric losses of N may contribute to air quality problems and impacts on neighbors. Higher application rates of manure could result in greater accumulation or environmental loss of P and a greater concentration of K in crops, potentially leading to K toxicity.

The nutrient management plans have implications for the fate of N. Based on an improved balance of nutrients on the farm and a more even distribution of manure, there is little doubt that the plans would reduce the risk of groundwater contamination and the cost of fertilizers. However, wider distribution of manure or longer manure storage intervals could increase air

quality concerns. Also, more spreading of manure in the spring and late fall, when row crops are not in place and soils may be saturated, could increase the risk of runoff and create temporary labor and equipment shortages (see Part IV, Rasmussen et al.).

Nutrient balances in Bacon et al. (1990) showed whole farm N, P, and K net excess from 50 to 60%, somewhat lower than this study. However, the farms in our study were very different, with more lactating cows (320 and 525 versus 65) and higher milk production (26,000 and 24,000 versus 14,500 lb/(cow•year)). Apparent net excess of N in the barns subunit of Bacon et al. (1990) was 22 to 25% and thus was lower in the present study (5% and 1%). Accumulation of N in the fields subunit was 20 to 30% for Bacon et al. (1990), but environmental losses were not included. In our study, environmental losses for Farms A and B, respectively, were predicted to be 35% and 29% of N inflows to the fields, which is comparable to the N retained in the fields of Bacon et al. (1990).

Determining nutrient balances on farm subunits was difficult for several reasons. One was the shortage of records for farm practices in earlier years, including distribution and timing of manure and fertilizer applications. Because of this, we used the nutrient management plan to project manure and fertilizer use. Also, crop yields for the study year, which were unusually high, were unlikely to be repeated. In general, we were forced to use a mixture of "snapshot" data such as animal rations and inventories, and cumulative data such as annual purchases. This was particularly problematic because all of the farm and herd parameters were constantly changing, including milk production, animal numbers, rations, animal intakes, and manure production and composition. Development of a record keeping system will be integral to nutrient accounting on other farms (Lemberg et al., 1992).

CONCLUSIONS

Losses of N through manure handling and storage on the case farms A and B were estimated to be 16% and 19% of excreted N. Leaching of N to groundwater accounted for 9% and 8% of the total inflows to Farm A and Farm B, and 7% of N inputs to the fields of both farms. On both farms the majority of the leached N was concentrated on the best drained soils. For instance, on Farm A, about 70% of leached N was concentrated on 25% of the crop area, which was associated with the most well drained soils. Total environmental losses accounted for over 75% of the retained N on Farm A and 67% of the retained N on Farm B. Net excess of P on the whole farm units was primarily associated with P net excess in the fields. Implementation of the nutrient management plan was projected to reduce P and K net excess on Farm A and N, P and K use on Farm B.

ACKNOWLEDGMENT

We wish to thank Julie Monaco for her assistance with the manure sampling and manure loss model.

REFERENCES

- ASAE. 1992. Manure production and characteristics. p. 484-486. *In* ASAE Standards. ASAE, St. Joseph, MI.
- Bacon, S. C., L. E. Lanyon, and R. M. Schlauder. 1990. Plant nutrient flow in the managed pathways of an intensive dairy farm. *Agron. J.* 82:755-761.
- Fritton, D. F., and G. W. Olson. 1972. Depth to apparent water table in 17 New York soils from 1963 to 1970. p. 37. *New York Food Life Sci. Bulletin* 13, Cornell Univ. Agric. Exper. Sta., Ithaca, NY.
- Hutson, J. L., and R. J. Wagenet. 1991. Simulating nitrogen dynamics in soils using a deterministic model. *Soil Use Management* 7:74-78.
- Hutson, J. L., and R. J. Wagenet. 1992. LEACHM -- Leaching estimation and chemical model, version 3. Research Series 92-3, Dept. of Soil, Crop, and Atmos. Sci., Cornell Univ., Ithaca, NY.
- Hutson, J. L., D. S. Wilks, C. J. Duffy, and J. H. Peverly. 1988. Modeling annual cycles of soil water regimes in New York soils. Res. Project Report, Water Resources Inst., Cornell Univ., Ithaca, NY.
- Klausner, S. D., D. G. Fox, T. P. Tylutki, W. C. Stone, L. E. Chase, and R. E. Pitt. 1996. Integrating knowledge to improve dairy farm sustainability I: objectives, procedures, and lessons learned. (submitted).
- Lemberg, B., W. T. McSweeney, and L. E. Lanyon. 1992. An information management technology program for ex ante nutrient loss reduction from farms. *J. Environ. Qual.* 21:574-578.
- Morse, D., R. A. Norstedt, H. H. Head, and H. H. Van Horn. 1994. Production and characteristics of manure from lactating dairy cows in Florida. *Trans. ASAE* 37:275-279.
- Muck, R. E., and T. S. Steenhuis. 1981. Nitrogen losses in free stall dairy barns. p. 406-409. *In* Proc. Fourth Internat. Symp. Livestock Waste, Livestock Waste: A Renewable Resource. ASAE, St. Joseph, MI.
- Muck, R. E., and T. S. Steenhuis. 1982. Nitrogen losses from manure storages. *Agric. Wastes* 4:41-54.
- National Research Council. 1988. Nutrient requirements of dairy cattle, sixth edition. National Academy Press, Washington, DC.

- Rasmussen, C. N., J. J. Hanchar, and P. E. Wright. 1996. Integrating knowledge to improve dairy farm sustainability IV: economic evaluation of alternatives to improve nutrient efficiency. (submitted).
- Saama, P. M., B. E. Koenig, H. E. Koenig, and J. H. Anderson. 1994. Analytical tools for material and energy balance, cash flow, and environmental loads in a dairy cattle enterprise. *J. Dairy Sci.* 77:994-1002.
- Soil Survey. 1971. Cayuga County Soil Survey, New York. USDA-SCS and Cornell Univ. Agric. Exper. Sta. May, 1971.

**Integrating Knowledge to Improve Dairy Farm
Sustainability - Part IV:**

**Economic Evaluation of Alternatives to
Improve Nutrient Efficiency**

C. N. Rasmussen, J. J. Hanchar, and P. E. Wright

ABSTRACT

This paper illustrates the use of farm management principles to evaluate proposed changes in the farm business (alternatives). The alternatives were proposed to decrease nutrient loading and potential loss of nutrients to the environment on two case study farms. The alternatives are evaluated from an economics and management perspective based upon criteria related to farm business objectives including continued farm profitability and feasibility given available land, labor and capital resources. Alternatives proposed included reformulating dairy cattle rations to improve nutritional efficiency and implementing an agronomic nutrient management plan (NMP) that allocates manure and fertilizer to fields in an agronomically appropriate fashion. On Farm A, the feasibility of the NMP was limited by the availability of manure storage and labor. Two additional alternatives were developed to overcome these resource limitations, constructing a manure storage pond and using custom hired labor to apply manure to fields. Partial budget analysis projected that on both case study farms, all the alternatives considered increased net farm income. Expected increases ranged from approximately \$1,400 to \$ 42,300 in an average future year. However, the projected impact on farm profitability was relatively minor compared to each farm's size and productivity.

INTRODUCTION

By definition, a farm's sustainability depends on its continuing economic viability (Alatieri, 1989; Francis, 1995; Fretz et al., 1993; NRC, 1991; Stockle et al., 1994). Farm sustainability also depends upon achieving business and individual objectives of the farm owner and family, and the availability of resources. Maximization of profit is normally a primary business objectives. A farm's sustainability also depends on being environmentally acceptable to society. Adoption of environmentally sound management practices will depend on forces internal to the business such as farm productivity, profitability and a commitment to land stewardship, and forces external to the business such as market forces, conformance to government regulations, litigation or the threat of litigation, and social pressures.

The purpose of this research project was to develop a process for integrating knowledge to promote dairy farm sustainability. A farmer achieves business, individual and environmental objectives by making decisions which allocate limited land, labor and capital resources among competing uses. To make such decisions, a farmer collects information about the current situation and observes areas where the current situation deviates from desired conditions. The farmer then tries to identify underlying causes of problems, and generates a set of possible solutions to each problem. These alternative solutions are then evaluated based on the degree to which they help to achieve farm objectives. These activities of farm managers are described as problem solving (Hutt et al., 1989). Part I describes The Dairy Farm Sustainability Project as focusing on problem solving aspects of planning (Fox et al.). Other sections of this report focus on processes for identifying problems, diagnosing problems, and evaluating alternatives from animal, agronomic, and water quality perspectives.

Part IV outlines an approach for evaluating alternatives from an economic and management perspective; and illustrates the approach by evaluating some of the proposed changes to the two case study farms discussed in other parts of this report. A primary objective of these farms is to minimize any negative impact they may have on water quality while maintaining or

enhancing farm profitability. Mass nutrient balances indicate that under current management practices, between 60% and 85% of the N, P and K brought on the farms did not leave as a product and remained unaccounted for (Klausner et al., 1996). These excess nutrients present a potential water quality problem (Hutson et al. 1996). Two alternatives to decrease nutrient loading and potential loss to the environment are reformulating dairy cattle rations to improve nutritional efficiency and implementing agronomic nutrient management plans (NMP) that allocate manure and fertilizer to fields in an agronomically appropriate fashion.

A review of the literature shows that practices designed to achieve environmental objectives can be expected to have positive or negative effects on measures of profit depending on the nature of the environmental objectives, available resources, and other conditions specific to the farm and region studied. When environmental objectives are met by more efficient allocation of resources and better use of information, economic efficiencies are also realized. Coote et. al. (1975) stated that since nutrients constitute a scarce resource, policies designed for economically efficient nutrient use may also be environmentally sound. When nutrients were conserved using a variety of management practices, including optimal timing and rate of fertilizer application (Johnson et al, 1991; Lemberg et al. 1992), cover crops and animal manure use (Norris and Shabman, 1992), farm profits increased or negative effects on income were minimal. At the same time, several researchers found that environmental restrictions which change the level of farm intensity as measured by cows/land unit or land use patterns may substantially decrease farm net return (Coote et. al. 1975; Jacobs and Timmons, 1974; Schmit and Knoblauch, 1994; Westphal et. al., 1989).

Other factors influencing the economic impact of controlling nutrient loss are the cost and availability of information and the farmers aversion to the risk of production decline. Lemberg et. al. (1992) reported that where information is obtainable, such as manure and soil analysis, the cost of the information was more than offset by the savings in fertilizer expenditures. McSweeney and Shortle (1989) reported that a lack of information about manure nutrient content, soil nutrients and plant production response to manure and fertilizer could cause farmers to over apply manure and fertilizer. Especially, risk averse producers would be inclined to apply nutrients at rates in excess of those required to maximize profits.

METHODS

Functions of the farm manager include: planning, implementation and control (Kay, 1986). Problem solving involves the following steps: problem identification, problem diagnosis, the generation of alternatives and decision making. Other sections of this report identified and diagnosed potential nutrient problems and proposed alternative solutions. This section focuses on the decision making phase of the planning process. Decision making involves evaluating alternatives and choosing the best alternative(s). The following steps are used to evaluate alternatives:

1. establish criteria,
2. rate alternative based on criteria,
3. compare and rank alternatives based upon rating received.

These steps provide a framework for evaluating proposed nutrient management alternatives.

Establish Criteria

Farm business profitability and the feasibility of the proposed change given available land, labor and capital are the major criteria used for evaluation. Although not the only farm business objective, maximization of profit is useful as an objective, because profit is measurable and related to business growth and survival. The feasibility of alternatives is evaluated by comparing the requirements of the proposal with the available farm resources. Another criterion in this analysis, the sensitivity of a budgeted solution to changes in production was evaluated to indicate the risk of the proposed alternatives.

Rating Alternatives

To rate each alternative on profitability criteria requires an estimate of the expected change in net farm income associated with the proposed change in the farm business. Net farm income is the total return to the farm operator(s) and other unpaid family members for their labor, management and equity capital (Kay, 1986). The partial budget approach is used to estimate the expected change in net farm income associated with the proposed alternative in an average future year (Kay, 1986). The partial budget contains only those income and cost items that change if the proposed change in the farm business is implemented (Kay, 1986). The change in net farm income is calculated by itemizing all items that will change in response to implementing the proposed solution and subtracting items that reduce net farm income (reduced income and added costs) from items that increase net farm income (added income and reduced costs). Since both case study farms are actual working farms with many conditions changing simultaneously, it was difficult to fix a baseline point from which the partial budget comparisons are made. For illustrative purposes, the baseline point is considered to be "current farm practices in an average future year" before implementation of alternatives.

Product prices and input costs are available from the authors. The labor cost included direct labor expenses, workmen's compensation, unemployment insurance and employee benefits. The analysis assumes that the farmers can hire or allocate more or less labor as needed. Change in costs are calculated by multiplying the additional or reduced hours required by the value of labor per hour. The machinery repair and maintenance costs and fuel and lubricant costs per hour were calculated using ASAE standard formulas (ASAE 1993). These formulae use the machine's original manufacturer's list price, age and estimated useful life to determine the repair and maintenance cost per hour of use. The fuel and lubricant cost per hour of use was determined using ASAE equations using the horsepower of the tractor and the fuel cost per gallon. Hours required for fertilizer application and manure handling were estimated using engineering calculations. Distances from manure storage ponds and barns to fields were estimated, for simplicity, using the direct line distances measured from an aerial photo.

Partial Budget Analyses

The expected change in farm profitability resulting from each alternative was estimated using partial budgets. For farm B, one partial budget was constructed to estimate the impact of the NMP on annual net farm income. The milk production, crop production mix, yields and crop quality were assumed to be unchanged. The total quantity of manure applied to the fields was unchanged but the allocation was changed by the NMP. On farm B, all field application except for manure, starter fertilizer and anhydrous ammonia application are custom hired. The custom hire operator provides the machinery, labor and fuel.

For farm A, a series of partial budgets were constructed to analyze several farm business changes. The first budget in this series analyzes reformulating dairy cattle rations to improve metabolic efficiency while limiting nutrient use and excretion. The following three budgets consider implementing a NMP with and without the construction of remote manure storage and use of custom hired labor to agitate and spread manure from the remote storage area.

Comparing and Ranking Alternatives

Alternatives represent possible solutions to a problem. Alternatives can be rated on criteria given estimates of expected changes in net farm income, the land, labor and capital required for each alternative and the resources available. A decision making grid, Figure 1, is useful for documenting the results of rating each alternative on each criterion. For illustration, Figure 1 contains suggested criteria for evaluating alternatives and a scale for rating alternatives on each criterion. In the grid, the expected impact of the alternatives are given a score of 1 (good) to 3 (poor) for each criteria. A decision making grid such as Figure 1 allows for side by side comparison and ranking of alternative possible solutions to a problem. The decision maker assigns a weight to each criterion. Totals, a weighted sum of the ratings, provide a basis for ranking the alternatives and information for selecting from among the set of possible solutions.

Figure 1. Farm A, decision making grid

Ratings: 3 - Good rating for criterion
 2 - Fair rating for criterion
 1 - Poor rating for criterion

Problem: Mass nutrient balances indicate that under current management practices
 59 to 71 % of N,P, and K imported to farm are unaccounted for.

Economics and Management Rating Criteria†	CNCPS Ration Formulation	NMP	NMP w/ remote storage	NMP w/ remote storage & custom spreading
Expected change in net farm income ≥ 0	3	3	3	3
Maximize expected change in net farm income	3	1	1	1
Feasibility - land constraints	3	1	3	3
Feasibility - labor constraints	3	1	1	3
Feasibility - current capital assets (e.g. manure storage and pump available)	3	1	3	3
Totals	15	7	11	13
Ranking	1	4	3	2

† All criteria given the same weight (1).

RESULTS

In Table 1, the adoption of the nutrient management plan for Farm B is compared to current management practices. Adopting the NMP reduces farm costs associated with a decrease in fertilizer application. The quantity of nitrogen, phosphorus and potassium from commercial fertilizer recommended by the NMP is respectively 9, 4 and 38 tons less than that used under current practices (Table 2). The estimated net decrease in costs is \$17,058. The additional costs associated with the NMP include charges for additional machinery repair and maintenance, fuel and labor. The NMP requires more machinery and labor hours because the manure is spread on more acres at a lower rate per acre. Under current practices, approximately 41 machine and labor hours are used to spread an average of 17,185 gal on 400 acres. In the NMP, 65 hours are used to spread an average of 14,000 gal on 491 acres. The increase in cost is modest, \$ 1,057. The change in net farm income that could be expected from adopting the NMP is \$ 16,001.

Table 1. Impact of NMP on Farm B annual net farm income†

Items That Add to Net Income		Items That Reduce Net Income	
Added Returns		Reduced Returns	
None		None	
Reduced Costs		Added Costs	
<u>Variable (Operating):</u>		<u>Variable (Operating):</u>	
1. Reduced purchases of fertilizers	\$ 15,368	1. Change in manure allocation	
A. Material		A. Tractor repair and maintenance	\$ 483
B. Application		B. Tanker-truck repair and maintenance	189
1. Custom hire	\$ 997	C. Fuel	149
2. Repairs and maintenance	340	D. Labor	236
3. Fuel	116		
4. Labor	237		
Total: Added Returns and Reduced Costs (A)	\$ 17,058	Total: Reduced Returns and Added Costs (B)	\$ 1,057
		Change in Net Farm Income (A minus B)	\$ 16,001

† Assumptions:

- 1) Production of milk, feedstuffs, rotations, yields and quality are unchanged.
- 2) Total quantity of manure applied to fields is unchanged but allocation by field is changed.

Table 2. Total quantity of nutrients from commercial fertilizer used on Farm B.

Nutrient	----- Tons of Nutrient -----		
	1994	NMP	Change
N	30	21	9
P	16	12	4
K	49	11	38

A series of partial budgets was developed to evaluate the ration reformulation and soil/crop nutrient management plan (NMP) alternatives proposed for Farm A (Tables 3,4,5 and 8). In Table 3, the projected impact of reformulating the rations was an increase in annual net farm income of \$42,300. Ration reformulation included an increase in milk production and changes in purchased feed costs and expenses (feedstuff analyses and nutritional consulting). The metabolic energy required to excrete excess ruminal nitrogen (urea cost) was decreased by ration reformulation by about 0.5 Mcal of net energy per day (see Part II, Klausner et al.). This reduction in absorbed energy requirement was estimated to result in a milk production increase of 1 lb/cow/day (Stone et al.,1992), or 305 lb per cow per year including dry periods. In actuality, rolling herd average milk production increased 1,062 lb. per cow per year during the study period. Thus, the portion of this increase which could conservatively be attributed to increased nutrient efficiency was 30% of the actual increase experienced by the case study farm. The increased milk production attributed to ration reformulation was valued assuming a milk price of \$12.00 per hundred weight. The acres of haylage, corn silage, and high moisture corn produced before and after the ration changes were not substantially different. Labor records indicated that hours of hired labor did not change with the ration reformulation. Therefore, crop production and labor costs were assumed to be unaffected by the ration changes.

Table 3. Impact of CNCPS ration formulation on Farm A annual net farm income†

Items That Add to Net Farm Income		Items That Reduce Net Farm Income	
Added Income		Reduced Income	
A. Increased milk production due to a decrease in the energy required to excrete excess N (.48 mcal NE) = 305 lb./cow per year * 320 cows * \$0.12 /lb. milk	\$ 11,712	None	
Reduced Costs		Added Costs	
<u>Variable (Operating):</u>		<u>Variable (Operating):</u>	
A. Reduced purchases of feed		A. Added purchases of feed	
1. Animal Protein	\$ 2,276	1. Soybean Meal	\$ 21,207
2. Protein Mix	41,466	2. Minerals	9,306
3. Cotton seed	27,592	3. Corn Meal	15,056
4. Tallow	8,437	B. Nutritional consultant and feed analyses	3,600
Total: Added Income and Reduced Costs (A)	\$ 91,483	Total: Reduced Income and Added Costs (B)	\$ 49,169
		Change in Net Farm Income (A minus B)	\$ 42,314

†Assumptions:

1) Production of feedstuffs, rotations, yields and quality are unchanged

In Table 4, an analysis of implementing the crop/soil NMP on Farm A was conducted. The NMP changed fertilizer material and application costs. It was assumed that there would be no reduction in crop yields associated with implementing the NMP. Because the case farm was already allocating manure throughout the farm and applying fertilizer at levels approximating nutrient management plan recommendations, the savings in fertilizer usage and resulting increase in budgeted net farm income was only \$1,350.

Under current practices on Farm A, 40 to 45 acres of crop land are left fallow and used as manure disposal fields. The fields designated for this purpose are rotated each year. This acreage receives 29 to 47 thousand gallons of manure per acre, compared to the fields in crop production which received 4 to 7 thousand gallons per acre. The NMP recommended the typical level of manure application for these manure-disposal fields. Over a four year period these fields were approximately the same distance from the barn as all other farm fields. Therefore, the expenses associated with spreading manure on these fields were not different from current practices.

Table 4. Impact of nutrient management plan on Farm A annual net farm income†

Items That Add to Net Farm Income		Items That Reduce Net Farm Income	
Added Income		Reduced Income	
None		None	
Reduced Costs		Added Costs	
Variable (Operating):			
A. Reduced purchases of commercial fertilizers			
1. Material	\$ 1,251		
2. Fertilizer application	99		
Total: Added Income and Reduced Costs (A)	\$ 1,350	Total: Reduced Income and Added Costs (B)	\$ 0
		Change in Net Farm Income (A minus B)	\$ 1,350

† Assumptions:

- 1) Production of feedstuffs, rotations, yields and quality are unchanged.
- 2) Total quantity of manure applied to fields is unchanged but allocation by field is changed.

In reality, implementation of the NMP was limited by land, labor, and capital resources. The first problem considered was the limitation on land available for manure disposal during crop production. Manure storage capacity was limited to 10 days; hence there was no existing method of manure disposal during the growing season other than spreading on the 40 acres designated for this purpose. Construction of a manure storage pond was considered to allow the producer to store manure both during the growing season and at other times when fields were inaccessible. Thus, an additional partial budget analysis, Table 5, considered the expected effect of the NMP including construction of an earthen manure storage pond. Because the farm was situated very close to a small town, the storage pond would to be built in a remote location on crop land 1.5 miles from the town. The storage pond size was determined by calculating the manure allocated to all the nearby fields in a year, allowing an additional 33% capacity for precipitation and other variable factors. Table 6 shows the initial investment, assumed useful life, and annual fixed ownership costs (depreciation, repairs, insurance, and interest) for the storage pond, road, and pump used for agitating and emptying the manure storage pond.

Table 5. Impact of nutrient management plan with construction of remote site manure storage pond on Farm A annual net farm income †

Items That Add to Net Farm Income		Items That Reduce Net Farm Income	
Added Income		Reduced Income	
A. Value of crops produced on land currently set aside for manure application during growing season. 40 Acres x \$523/acre average value of crops	\$20,920	A. Elimination of government payment for participation in set-aside program	\$1,200
Reduced Costs		Added Costs	
<u>Fixed (Ownership):</u>		<u>Fixed: (Ownership)</u>	
		A. Storage Pond	\$ 927
		B. Road	103
		C. Pump	1,751
<u>Variable (Operating):</u>		<u>Variable (Operating):</u>	
A. Costs associated with reduced commercial fertilizer purchases		A. Costs of producing crops on land currently used for manure application (40 acres x \$223/a)	\$ 8,920
1. Material	\$ 1,251	B. Load storage (.906 m. gal.)	
2. Application	99	1. Tank-truck r&m, fuel, lube	310
		2. Labor	237
		C. Unload storage (1.2 m. gal)	
		1. Agitation	
		a. Tractor r&m, fuel, lube	274
		b. Pump repair & main.	259
		c. Labor	58
		2. Load Tank-truck	
		a. Tractor r&m, fuel, lube	140
		b. Pump r&m	137
		c. Labor	316
		D. Spread additional volume due to precipitation (.3 m. gal)	
		1. Tank-truck r&m, fuel, lube	206
		2. Labor	157
Total: Added Income and Reduced Costs (A)	\$ 22,270	Total: Reduced Income and Added Costs (B)	\$ 14,995
		Change in Net Farm Income (A minus B)	\$ 7,275

† Assumptions:

- 1) Production of feedstuffs, rotations, yields and quality are unchanged.
- 2) Manure storage pond constructed with 1.2 million gallon capacity, 0.9 million gallons of manure transported to storage pond, 0.3 million gallons precipitation added, 1.2 million gallons water and manure spread on fields.
- 3) No additional transportation costs; 0.9 million gallons of manure spread on fields under current practices.
- 4) Fixed (ownership) costs include depreciation, insurance, interest and repairs on the manure storage pond and the road and depreciation, insurance and interest on the pump. Pump has 10 year useful life, 0 salvage value (Table 6).

Table 6. Farm A, manure storage pond initial investment and annual ownership costs

Item	Initial Cost	Useful life	----- Fixed (Ownership) Costs (\$/year) -----			
			Depreciation†	Repairs	Insurance	Interest‡
Earthen storage pond	\$ 7,942§	20 years	\$ 397	\$ 397	\$ 33	\$ 99
Road - 200 ft.	1,000	20 years	50	40		13
Pump	15,000	2,500 hours	1,500	¶	63	188

† Straight line depreciation.

‡ Interest charged at 2.5 % real rate annually over 20 years.

§ Storage pond initial cost includes construction cost of \$ 1 per cubic yard plus design and test pit excavation cost of \$ 2000.

¶ Pump repair is a variable expense and charged at \$ 4.80 per hour used.

With the addition of the manure storage pond, the land which was previously used for manure disposal would be available for crop production. To determine the crop production value of these 40 acres, the value and direct costs of each of the crops produced on the farm in a typical crop year were estimated, and the value of the crops was calculated as a weighted average of all crops in proportion to their acreage (Table 7). The weighted average market value of all crops produced on the farm (\$523 per acre), when multiplied by acreage, was considered added income. The direct cost of production was based on constructed enterprise budgets and was increased 4% per year to reflect inflation (Greaser, 1993). The weighted average direct cost of production (\$223 per acre) of producing a typical crop mix on the 40 acres was considered an added cost. The net return of crop production on these acres was the difference, \$300 per acre.

Table 7. Value and direct cost of crop production in average year on Farm A

Crop	Value \$/acre	Direct cost \$/acre	Return over Direct Cost \$/acre	Number acres	Return over Direct Cost/ crop (\$)
Corn Silage	421	186	235	209	49,115
Alfalfa Haylage	621	264	357	255	91,035
High Moisture Ear Corn	487	197	290	100	29,000
Hay	520	155	365	6	2,190
Total				570	171,340
Weighted Average	523	223			300

Table 5 gives the partial budget analysis for implementing the NMP including construction of the remote manure storage pond and the added net income from the additional crop acreage. The major contribution of \$20,920 of added income was from the value of crops produced on the acreage formerly used for manure disposal. Subtracting the cost of production of \$8,920 gave a net positive value of \$12,000 for the additional acreage. Because this land had been kept out of production, it was eligible to receive government payments under the USDA set-aside program. Thus, the value of these government payments, \$1,200, appeared as a reduction in farm income. The annual ownership and operating costs of the manure storage pond added a total of \$4,875 to costs. Annual net farm income was expected to increase by \$7,275 in this scenario. Thus, addition of a manure storage pond would be expected to increase net farm income on the case study farm if the budgeted income from the increase in crop production on the 40 manure storage acres was realized.

Availability of labor was another factor that limited the feasibility of the manure storage alternative on Farm A. The farm owner was concerned that labor for spreading manure and a tractor for agitation would be unavailable during the spring planting season when much of the manure would be spread. Therefore, an additional partial budget was constructed to consider hiring custom labor to agitate, pump and apply the manure from the remote storage pond (Table 8). Variable costs increased due to the custom operator charges, although the fixed and variable costs associated with agitating, pumping and spreading the manure were less. With these considerations, the expected increase in net farm as a result of implementing the NMP with manure storage pond and custom operator was reduced to \$3,193.

Both alternatives proposed for Farm A, reformulating rations to increase nutritional efficiency and the NMP, met the objectives of decreasing nutrient loading and possible loss to the environment (see Part III, Hutson et al.) while not adversely affecting farm profitability. The proposed ration change received good ratings for the feasibility criteria (Figure 1). The immediate and successful adoption of the proposed changes in rations by the producer supported the ratings given. When the alternatives are compared and ranked using the decision making grid, three of the alternatives, the ration reformulation and the NMP with manure storage both with and without custom hired labor had high scores (Figure 1). This implies that each of these alternatives does a good job of satisfying the criteria. In this case, multiple alternatives can be implemented. The ration reformulation alternative, ranked first, can be implemented in conjunction with one of the agronomic plans. The two alternatives which include manure storage have very similar scores. Making a decision between the agronomic plans may require the consideration of additional criteria. For instance, custom manure applicators may not be available on a timely basis, increasing the risk of production loss. It may be useful to consider other refinements of these alternatives, for example, hiring extra labor on a seasonal basis and /or renting or purchasing an additional tractor.

This paper illustrates an approach for evaluating alternatives using a limited set of criteria. Environmental criteria would provide a basis for evaluating alternatives in a manner that is consistent with the focus on sustainability. For example, "obtain a targeted reduction in the percentage of nutrients imported on to the farm that are unaccounted for based upon a mass nutrient balance analysis," may be an appropriate criterion. Ratings for each alternative on this criterion, comparison and ranking could proceed in a manner analogous to that outlined in this paper.

Table 8. Impact of NMP with construction of remote site manure storage pond, manure application done by custom operator on Farm A annual net farm income †

Items That Add to Net Farm Income		Items That Reduce Net Farm Income	
Added Income		Reduced Income	
A. Value of crops produced on land currently set aside for manure application during growing season. 40 Acres x \$523/acre aver. value of crops	\$20,920	A. Elimination of government payment for participation in set-aside program	\$1,200
Reduced Costs		Added Costs	
<u>Fixed (Ownership):</u>		<u>Fixed: (Ownership)</u>	
		A. Storage Pond	\$ 927
		B. Road	103
<u>Variable (Operating):</u>		<u>Variable (Operating):</u>	
A. Costs associated with reduced commercial fertilizer purchases	\$ 1,350	A. Costs of producing crops on land currently used for manure application (40 acres x \$223/a)	\$ 8,920
B. Costs associated with spreading .9 million gallons manure		B. Load storage (.9 million gal)	
1. Repairs and maint.	413	1. Tank-truck r&m, fuel, lube	310
2. Labor	475	2. Labor	237
		C. Unload storage (1.2 m. gal)	
		1. Agitation - tractor fuel	176
		2. Load Tank-truck - tractor fuel	89
		D. Spread additional volume due to precipitation (.3 million gallons) Tank-truck fuel	69
		E. Custom Operator Charges \$ 75/hour x 157 hours	7,934
Total: Added Income and Reduced Costs (A)	\$ 23,158	Total: Reduced Income and Added Costs (B)	\$ 19,965
		Change in Net Farm Income (A minus B)	\$ 3,193

† Assumptions:

- 1) Production of feedstuffs, rotations, yields and quality are unchanged.
- 2) Manure storage pond constructed with 1.2 million gallon capacity. Farm owner additional expenses include ownership costs associated with capital investment in manure storage pond and road. Pump is supplied by custom operator.
- 3) No additional transportation costs; 0.9 million gallons of manure spread on nearby fields under current farm practices. Farm operator loads 0.9 million gallons of manure into storage pond. Precipitation adds 0.3 million gallons of water to storage pond.
- 4) Custom operator pumps out and spreads 1.2 million gallons water and manure on nearby fields. Custom operator provides agitating pump and power, tank-truck and labor. Custom operator does not supply fuel.
- 5) Fixed (ownership) costs include depreciation, insurance, interest and repairs on the manure storage pond and the road. See Table 6.

Sensitivity Analysis

A possible producer objective may be to minimize the risk of decreased milk and crop production. In each of the partial budgets, it was assumed that crop yields were unaffected by the proposed NMP alternatives. Both the ration reformulation and the NMP would decrease the nutrient safety factor that was previously an intrinsic part of feeding management and fertilizer application practices. We did not attempt to predict a production loss associated with limiting the supply of nutrients to the cows or crops in this analysis. In fact, these practices may have increased productivity by increasing efficiency and promoting better management awareness of critical production issues. For example, ration reformulation contributed to increased milk production by decreasing energetic costs of excreting excess nitrogen. Implementing the Cornell Net Carbohydrate and Protein System model invoked other management changes such as close monitoring of animal dry matter intake, frequent and accurate feed analysis, careful attention to bunker-silo and feed-bunk management, effective control of ration mixing and delivery, and careful monitoring of milk production and body condition. These changes may also have contributed to increases in milk production. Similarly, the NMP may promote an increased awareness of fertilizer and manure application, which would have had a beneficial effect on crop production.

The sensitivity to possible changes in productivity as a result of implementing alternatives could be critical to farm profitability. Profitability is sensitive to changes in milk production and crop yields. On the large case study farms, the expected impact of the proposed alternatives (Tables 1,3,4,5 and 8) were small compared to the potential impact changes in milk or crop production would have. For example, a yield decrease of about 1 and 3.5 % of all crops produced on farms A and B respectively (Tables 8 and 1), would have eliminated any benefit of the NMP. Changes in farm profit from the ration reformulation on Farm A (Table 3), which had the most dramatic effect on farm profitability, would have been zero if there was a 3.4% decline in milk production. Other management practices and external factors (weather, pests, etc.) may have a greater impact on productivity and risk potential than the proposed alternatives.

DISCUSSION

The impact of the proposed alternatives on net farm income must be considered in a broader context. Even though each of the alternatives considered in this analysis had a positive impact on net farm income, the impact was relatively minor compared to each farm's size and revenues. Furthermore, the impact of the alternatives on the farm profitability may not be as important to the decision making process as the plans ability to meet the other objectives and goals of the decision maker. Other factors may dictate the degree to which farm practices which address environmental quality issues will be implemented. These factors may include the management time required to implement the plan. Limited management time may be directed at concerns that have a greater impact on farm profitability. Secondly, the farm managers attitude toward risk may influence the degree a plan is used. Minimizing risk is a pertinent but sometimes unspoken objective. A producer may be willing to purchase and use excess nutrients to insure against the possibility of lower productivity due to limited nutrients. Also, the logistics of how well the farm manure storage, machinery complement and labor lend themselves to implementing the plan will be important. And finally, the desire of the farm manager to limit nutrient loss to the environment may be the most important issue.

CONCLUSIONS

The sustainability of an agricultural system depends on the ability of the farm manager to organize resources on the farm in ways that sustain environmental quality and enhance the economic viability of the farm business. Depending on many site-specific factors, there may be trade-offs between environmental and farm business goals. On the case study farms, the NMP and ration reformulation alternatives proposed resulted in an increase in net farm income. However the size of the increase was relatively small compared to the size of each farm's revenue and expenses. This is consistent with results found by other researchers (Coote et. al. 1975, Johnson et. al. 1991, Lemberg et. al. 1992, Norris and Shabman, 1992). Decisions concerning the appropriate farm management practices which will meet both environmental and farm business goals will depend on the resources and objectives of the farm in question. A planning process which includes specification of objectives and goals, problem identification and diagnosis, the generation of alternatives and decision making provides a useful framework for organizing the combination of resources which will achieve farm business and environmental quality objectives.

ACKNOWLEDGMENT

We wish to thank Kim White for her assistance with manure storage pond design.

REFERENCES

- Alatieri, M.A. 1989. Agroecology: A new research and development paradigm for world agriculture. *Agriculture, Ecosystems and Environment* 27:37-46.
- ASAE Standards. 1993. Field efficiency, field speed and repair and maintenance cost parameters. ASAE, St. Joseph, MI.
- Coote, D.R., D.A. Haith, and P.J. Zwerman. 1975. Environmental and economic aspects of nutrient management on the New York dairy farm. *SEARCH Agriculture* 5(5), New York Agricultural Experiment Station, Cornell University, Ithaca, NY.
- Fox, D.G., C.N. Rasmussen, R.E. Pitt, J.J. Hanchar. 1996. Integrating knowledge to improve dairy farm sustainability - part I: objectives, procedures and lessons learned. (submitted).
- Francis, C. 1995. What is sustainability? p. 70-76. *In Proc. Agriculture and People - Building a Shared Environment*. Ithaca NE. 9-10 October 1995. Univ. of Nebraska, Ithaca, NE.
- Fretz, T.A., D.R. Keeney, and S.B. Sterrett. 1993. Sustainability: defining the new paradigm. *Hort. Technology* 3:118-126.
- Greaser, G.L. 1993. The farm management handbook. Pennsylvania State College of Agriculture, University Park, PA.
- Hutson, J. L., R. K. Koelsch, R. E. Pitt, and R. J. Wagenet. 1995. Integrating knowledge to improve the sustainability of dairy farming III: environmental losses and nutrient flows. (submitted).
- Hutt, G.K., R.A. Milligan, J.B. Kaufman III, and E.A. Claypoole. 1989. Management resource handbook. A.E. Extension 89-22, Agronomy mimeo 89-5, Animal Science Mimeo 119. Cornell University, Ithaca, NY.
- Jacobs, J.J. and J.F. Timmons. 1974. An economic analysis of agricultural land use practices to control water quality. *Amer. J. Agric. Econ.* 56:791-797.
- Johnson, S.L., R.M. Adams, and G.M. Perry. 1991. The on-farm costs of reducing groundwater pollution. *Amer. J. Agric. Econ.* 73:1063-1073.
- Kay, R.D. 1986. *Farm Management: Planning, Control and Implementation*, 2nd Edition. McGraw Hill Book Company, New York, NY.

- Klausner, S.D., D.G. Fox, T.P. Tylutki, W.C. Stone, L.E. Chase and R.E. Pitt. 1996. Integrating knowledge to improve the sustainability of dairy farming II: plant and nutrient management. (submitted).
- Lemberg, B., W.T. McSweeney and L.E. Lanyon. 1992. An information management technology program for ex ante nutrient loss reduction from farms. *J. Environ. Qual.* 21:574-578.
- McSweeney, W.T. and J.S. Shortle. 1989. Reducing nutrient application rates for water quality protection in intensive livestock areas: policy implications of alternative producer behavior. *Northeast J. Agric. Res. Econ.* 18:1-11.
- National Research Council. 1991. *Toward sustainability, a plan for collaborative research on agriculture and natural resource management.* National Academy Press, Washington, DC.
- Norris, P.E. and L.A. Shabman. 1992. Economic and environmental considerations for nitrogen management in the mid-Atlantic coastal plain. *Amer. J. of Alternative Agric.* 7:148-155.
- Schmit T.M. and Knoblauch, W.A. 1994. The impact of nutrient loading restrictions on dairy farm profitability. *J. Dairy Sci.* 78:1267-1281.
- Stockle, C.O., R.I. Papendick, K.E. Saxton, G.S. Campbell, and F.K. van Evert. 1994. A framework for evaluating the sustainability of agricultural production systems. *Amer. J. Alternative Agric.* 9:45-49.
- Stone, W.C., L.E. Chase and D.G. Fox. 1992. Field application of the Cornell Net Carbohydrate and Protein System model in a progressive dairy herd. pp. 168-179. *In Proc. Cornell Nutrition Conf. Feed Manuf.*, Cornell University, Ithaca, NY.
- Westphal, P.J., L.E. Lanyon, and E.J. Partenheimer. 1989. Plant nutrient management strategy implications for optimal herd size and performance on a simulated dairy farm. *Agricultural Systems* 31:381-394.

Integrating Knowledge to Improve Dairy Farm Sustainability - Part V:

Manure Management

R. K. Koelsch

ABSTRACT

An effort to review the manure management practices and the nitrogen losses between the cow and the field of two case study farms (Farm A and Farm B) has produced the following conclusions:

- Dilution water additions to the manure slurry account for 40 to 50% of the volume of product that must be handled and contributes substantial additional time and capital costs to that required for manure management.
- Ammonia volatilization loss estimates from the barn floor and manure storage range from 12 to 17% of the total nitrogen in manure. Knowledge of this loss has minimal value to these two farms since current manure application practices treat ammonia as a waste product. Since volatilization is a key mechanism for nitrogen losses, efforts to document the flow of nitrogen for these farms must include this loss.
- The implementation of nutrient management planning may have negative implications in the form of odor nuisance, soil compaction, and demands on equipment and labor resources. Alternative handling and application systems are recommended that can minimize possible negative implications of nutrient management planning.

INTRODUCTION

Objectives

The primary objectives of this component of the project was to:

1. Determine characteristics and quantities of manure and milking center waste produced.
2. Estimate the nitrogen losses between excretion of manure by the cow and application of the manure to the field.
3. Review the manure management systems currently in place.

Procedures

Three data collection visits were made to Farm A (June 23, August 12, and October 28, 1994) and Farm B (July 5, August 12, and October 18, 1994). These visits involved the following activities

- Collection of manure samples from the milking herd (Farm A and B) and bred heifer herd (Farm B farm only). Samples were collected from areas where manure was directed from barns through the manure storage. Samples were collected at three points: A) immediately following excretion, B) at the end of its residence time on the barn floor, and C) upon removal from storage (see Figure 1).
- Counting of animal inventories for all barns
- Collection of barn floor temperature data.
- Identification of waste management facilities, equipment and management practices.

Figure 1. Illustration of nitrogen flows for dairy farm and the points at which this activity tried to measure nitrogen concentration (A, B, and C).

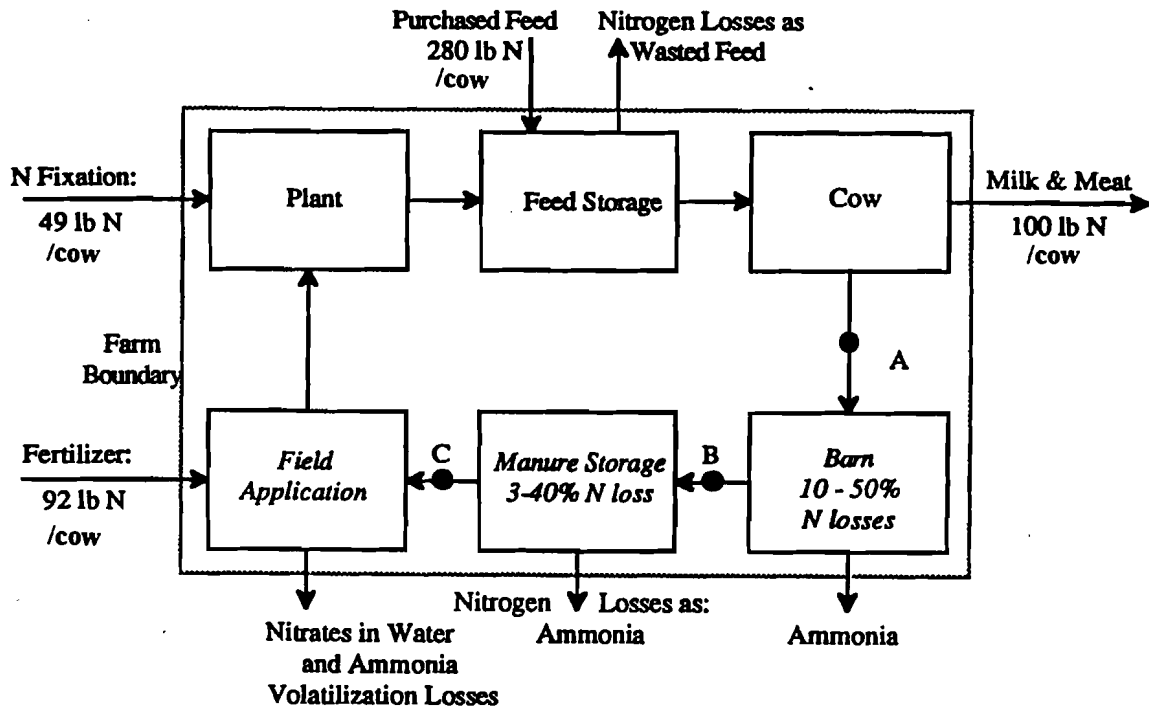

In addition, Farm B was visited daily for an eight day period (October 1994) to track level changes in three short term reception pits for the purpose of determining manure and milking center quantities produced. A similar effort was not made for Farm A because of our inability to separate manure production from milking center waste water and other water additions.

Collection of manure samples directly following excretion by the cow proved our most challenging data collection effort. During our initial visit, sections of alley approximately eight feet long were scraped as cleanly as possible. Manure and urine were allowed to fall for 1/2 hour period, then mixed as well as possible, and sampled. For a variety of reasons, we determined that this was not an appropriate method for sampling freshly excreted feces and urine. For the next two visits, samples of feces and urine were collected separately prior to their hitting the barn floor. Five or more animals were sampled from each barn except in the bred heifer barn where sample collection proved much more challenging. Urine and feces were analyzed separately and composite estimates were made of the combined urine and feces characteristics based on data from Morse (et al., 1994) and 1992 ASAE Standards. Manure analysis was conducted by Northeast Dairy Herd Improvement Association (DHIA) manure testing laboratory. Standard data reports used by DHIA (total nitrogen, ammonia nitrogen, organic nitrogen, phosphorus, potassium, and total solids) were supplemented with a measure of pH for most samples and urea for urine samples.

The campus related efforts focused on reviewing procedures for estimating ammonia losses from barn floor and manure storage. Procedures used by Muck and Steenhuis (1981) and Muck (1982) for barn floor losses and by Muck and Steenhuis (1982) for manure storage were adapted for use by this project. Appropriate spreadsheet tools were developed based upon these procedures, compared against data presented in the before mentioned papers and Muck and Richards (1983), and finally applied to facilities on the case study farms.

Modeling of barn floor ammonia losses was based on two components: urea conversion to ammonia and ammonia volatilization. Urea conversion to ammonia was modeled as follows: Volatilization of ammonia from a completely mixed liquid follows the following relationship:

$$\mu = \mu_m * \frac{S}{K_s + S} \quad (1)$$

μ :	rate of urea conversion	mg/(g•hr)
μ_m :	maximum rate of urea conversion	mg/(g•hr)
S :	urea concentration	mg/g
K_s :	urea concentration when μ is half of μ_m	mg/g

Volatilization of ammonia from a completely mixed liquid follows the following relationship:

$$C = C_0 * \exp[-K_g * a * f * t / H] \quad (2)$$

C :	concentration of ammonia at time t	mg/g
C_0 :	ammonia concentration at time 0	mg/g
K_g :	diffusion coefficient through a gas film	/hr
a :	surface to volume ratio	/cm
f :	fraction of unionized ammonia in solution	
H :	Henry's law constant	/cm

Loss of ammonia nitrogen from manure storage was a function of two processes: diffusion of ammonia through manure to the manure surface and volatilization of ammonia at the manure's surface (see equation 2). Diffusion was defined as follows:

$$J = -D * \frac{dC}{dz} \quad (3)$$

J:	ammonia flux	mg/(g•hr)
D:	diffusion coefficient	cm/hr
C:	ammonia concentration	gm/g
Z:	depth	cm

Results and Discussion

Data collected on manure characteristics and animal inventory is summarized in Table 1 and 2 for the two case study farms. Data was also collected or estimated on the volume of manure and milking center waste produced (figure 2).

Manure Characteristics

Manure samples collected just prior to storage (no opportunity for dilution water additions) ranged from 7.5 to 9.0% dry matter on Farm A. Manure samples taken at a similar location on Farm B ranged from 9.7 to 13.2% in the high group milking barn and between 8.5 and 12.3% in the low group milking barn and bred heifer barn. Manure leaving the storage ranged from 4.3 to 5.2% and 5.2 to 6.0% dry matter on Farm A and Farm B respectively. One sample taken from Farm A storage during the fall of 1993 was substantially higher. At this time, milking center waste was directed to a remote aerobic lagoon and not into the manure storage as is current practice.

The observed change in dry matter represents substantial additions of dilution water from the milking center, precipitation, and clean water additions for producing a more pumpable slurry. A measured water addition of 3400 gallons per day from the milking center was observed for Farm B. It would appear that water additions account for 40 to 50% of the liquid volume being hauled from manure storage. The additional equipment and labor investment for hauling water on both farms is substantial.

To reduce water additions to the manure stream, the following alternatives should be considered:

- Reduce milking center waste water production. As a minimum, water used for rinsing and washing the pipeline and bulk tank should be captured and reused for general cleanup activities in the parlor and holding area. Pipe line cleaning systems which reuse rinse and wash cycle water may be considered. Finally, water conservation by milkers should be promoted.
- Alternative treatment systems which eliminate tanker hauling should be considered for milking center waste water and runoff water from outdoor lots and concrete walkways. Aerobic lagoon treatment and/or vegetative filter strips are likely preferred options.
- Roof gutters which separate clean water from manure should be kept in good repair.

Table 1. Inventory of animals and summary of manure sample data collected on Farm B.

Date	Milking Herd		Dry Cow Barn	Bred Heifer Barn	Heifer Barn	Calves
	High Group Barn	Low Group Barn				
5-July-94	279	160	86	168	189	
12-August-94	284	170	106	142	204	
18-October-94	275	186	60	145	239	

Manure samples collected at time of excretion: High Group Barn							
Date Sample	5-July Combined	12-August			18-October		
		Urine	Feces	Combined	Urine	Feces	Combined
% of Combined ¹		38.5%	61.5%		38.5%	61.5%	
% N	0.481	1.170	0.410	0.703	0.460	0.380	
% NH3	0.199	0.040	0.022	0.029		0.010	
% Urea	0.004	0.860	0.007	0.335	0.460		
% Organic N	0.278	0.270	0.381	0.338		0.370	
% P	0.090	0.000	0.125	0.077		0.120	
% K	0.206	0.710	0.081	0.323		0.110	
% TS	9.474		11.656	7.168		12.100	7.442
pH	7.8	8.2	6.7	7.278			0.000
Manure samples collected at time of excretion: Low Group Barn							
% of Combined ¹		38.5%	61.5%		38.5%	61.5%	
% N	0.440	1.150	0.387	0.681		0.380	
% NH3	0.085	0.050	0.018	0.030		0.020	
% Urea	0.007	0.820	0.006	0.319	0.700		0.700
% Organic N	0.348	0.270	0.364	0.328		0.360	
% P	0.103	0.000	0.115	0.071		0.110	
% K	0.167	0.870	0.092	0.392		0.110	
% TS	11.299		11.357	6.985		12.010	
pH	7.1	8.3	6.5	7.193			
Manure samples collected at time of excretion: Bred Heifer Barn							
% of Combined ²		31.25%	68.75%		31.25%	68.75%	
% N		1.020	0.378	0.579		0.39	
% NH3		0.020	0.016	0.017		0.02	
% Urea		0.750	0.008	0.240	0.46		
% Organic N		0.250	0.355	0.322		0.37	
% P		0.000	0.114	0.078		0.08	
% K		1.110	0.115	0.426		0.09	
% TS			11.410	7.844		12.02	8.264
pH			7	4.813			

1 Morse (1994)

2 Muck (1981)

Table 1 (continued). Inventory of animals and summary of manure sample data collected on Farm B.

	Manure Samples Prior to Storage (new barn)				Manure Samples Prior to Storage (old barn)		
	5-July	12-Aug.	9-Sept.	18-Oct.	5-July	12-Aug.	18-Oct.
% N	0.546	0.346	0.410	0.550	0.575	0.510	0.490
% NH ₃	0.248	0.234	0.220	0.260	0.253	0.256	0.230
% Urea	0.011				0.009		
% Organic N	0.287	0.113	0.200	0.290	0.314	0.253	0.260
% P	0.095	0.083	0.060	0.100	0.090	0.089	0.080
% K	0.327	0.316	0.170	0.340	0.316	0.377	0.370
% TS	10.362	9.680	9.890	13.180	8.518	10.695	12.280
pH	7.2	7.5			7.3	7.5	

	Manure Leaving Storage		
	Fall 92	Jun-93	May-94
% N	0.360	0.300	0.360
% NH ₃	0.180	0.160	0.200
% Urea			
% Organic N	0.180	0.140	0.160
% P	0.063	0.058	0.063
% K	0.180	0.200	0.230
% TS	6.000	6.000	5.200
pH			

Farmstead manure storage : 275' X 115' X 20'
 North, south and east walls slope at 20°
 West wall slopes at 40°
 If filled to 18 feet of depth, average surface area is
 17,100 ft²

Remote manure storage: 200' x 110' x 20' with 30° sloping walls
 If filled to 18 feet of depth, average surface area is
 12,600 ft²
 Connected to farmstead storage by 8000' of 6 " plastic line

Barn Cleaning intervals:
 High Group Milking Barn...3 times a day
 Low Group Milking Barn...3 times a day
 Bred Heifer Barn...3 to 5 days
 Heifer Barn...3 to 5 days
 Dry Cow Barn...Every day

Application Equipment
 2 Husky tankers...3850 gallons each
 1 Husky tanker...3600 gallons
 1 box spreader

Table 2. Inventory of animals and summary of manure sample data collected on Farm A.

Date	Milking Herd Barn	Hospital	Dry Cow & Bred Heifer (>20 mo.) Barn	Heifer Barn (6-20 mo.)	Calf Barn (3-6 mo.)	Calves in Hutches
23-June-94	289		79	124	56	
12-August-94	273		79	154	27	
28-October-94	274	12	77	153	40	27

Date Sample	Manure samples collected at time of excretion						
	23-June Combined	12-August			28-October		
		Urine	Feces	Combined	Urine	Feces	Combined
% of Combined (assumed)		38.5%	61.5%		38.5%	61.5%	
% N	0.407	1.280	0.566	0.841	1.072	0.409	0.664
% NH ₃	0.096	0.690	0.025	0.281	0.025	0.022	0.023
% Urea	0.004	0.270	0.003	0.106	0.527		0.203
% Organic N	0.307	0.320	0.538	0.454	0.519	0.387	0.438
% P	0.114	0.030	0.121	0.086	0.010	0.128	0.083
% K	0.176	0.690	0.078	0.314	0.650	0.077	0.298
% TS	11.143		10.935	6.725	0.000	7.632	4.694
pH	7.1	8.3	6.8	7.378	7.9		

	Manure Samples Prior to Storage			Manure Samples After Storage		
	23-June-94	12-Aug-94	25-Oct-94	23-Nov-93	23-June-94	25-Oct-94
% N	0.569	0.486	0.571	0.42	0.26	0.439
% NH ₃	0.313	0.210	0.250	0.16	0.119	0.171
% Urea	0.001	0.000	0.000		0.003	0
% Organic N	0.255	0.276	0.321	0.26	0.138	0.268
% P	0.090	0.099	0.099	0.06	0.061	0.071
% K	0.365	0.302	0.360	0.19	0.12	0.236
% TS	8.877	9.375	7.525	10.68	4.271	5.231
pH	7.8	7.4			7.1	

Farmstead manure storage :
Barn Cleaning intervals:

Surface area is 2540 ft²
Milking Herd Barn...every 40 minutes
Dry Cow & Bred Heifer Barn...twice a week
Heifer Barn...twice a week
Calf Barn...twice a week

Application Equipment

Truck mounted liquid tankers...3560 gallons based upon average measured fill depth (5 samples)
1 box spreader

Figure 2. Dry matter characteristics and quantities of manure and waste water handled on Farm A and Farm B.

Farm B:

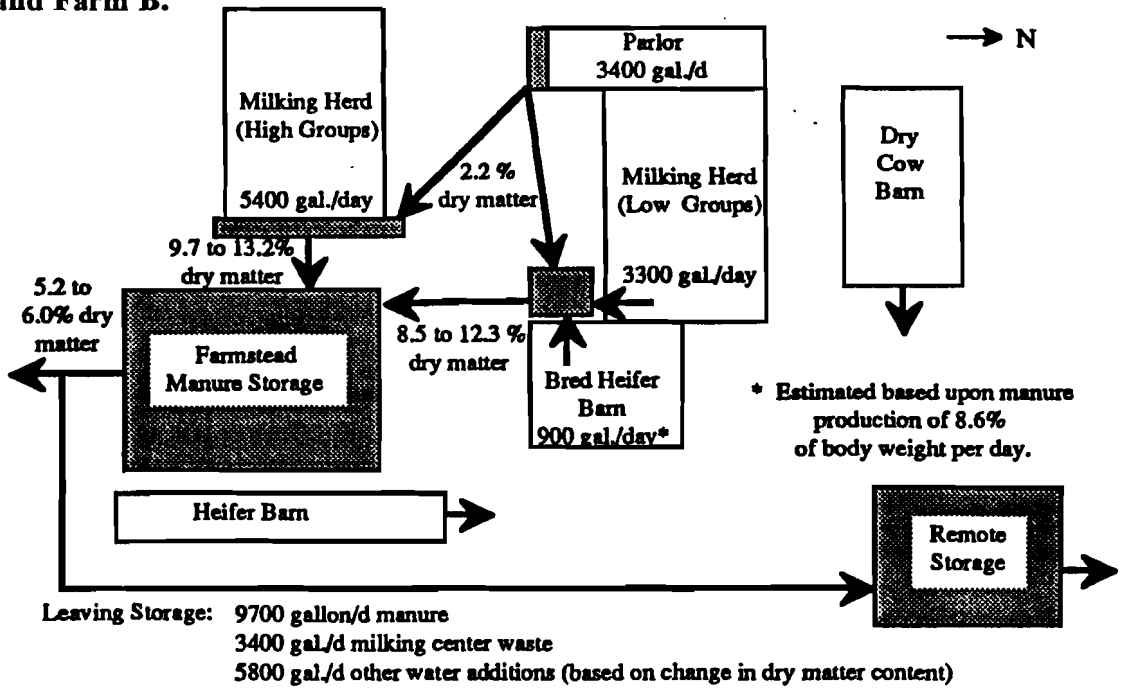

Farm A

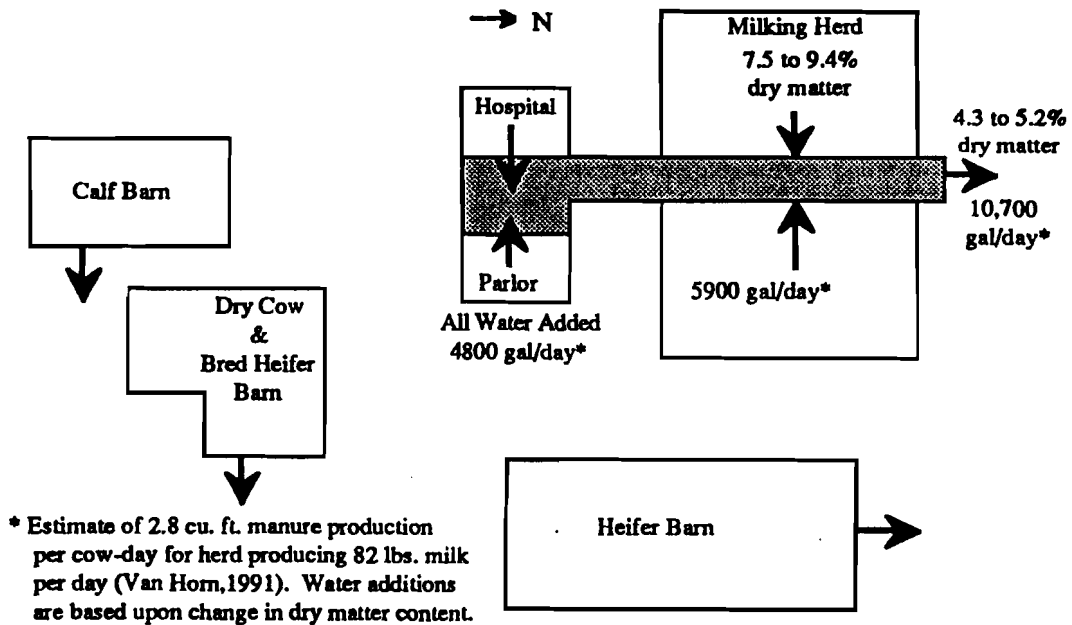

A reduction in water addition to the manure stream will produce a drier and more difficult waste stream for pumping. Alternative pumps capable of pumping 10% solids material and/or an overhead manure holding tanks which can be filled slowly with a low capacity pump and emptied quickly into a manure tanker parked underneath may meet the needs for handling manure without dilution of the manure slurry. For situations where manure is to be pumped extended distances, solids separation equipment should be considered for producing a lower solids material.

Nitrogen Losses

Measured urea concentrations suggest that between 44 and 51 % of total Kjeldahl nitrogen (TKN) is in this form. During most of the year, this form of nitrogen is converted to ammonia within relatively short periods of time. Ammonia nitrogen is susceptible to losses from the barn floor, manure storage, or following surface application of manure.

Efforts to replicate the model for barn floor losses as proposed by Muck and Steenhuis (1981) and Muck (1982) proved reasonably successful. Two primary challenges were encountered in the model preparation. First, although not clearly defined in the previously mentioned papers, it appears that the model assumes that manure and urine are not mixed on the barn floor and that the characteristics of urine (rather than urine and feces) should be used for the initial conditions. Since the models are a function of pH and urine has a higher pH than manure,, this assumption dramatically increases the predicted nitrogen losses. Second, the value of "a", surface to volume ratio, was undefined by the authors. A minimum value for "a" was selected at 10 cm^{-1} and as urine accumulation in the alleys resulted in smaller values of "a", a calculation of "a" was made based upon cumulative urine accumulation, alley area, and an assumption of no evaporation. With these assumptions, the model prepared for this project closely approximated the model results and data presented by Muck and Richards (1983).

Efforts to replicate the model for storage losses as proposed by Muck and Steenhuis (1982) were successful for bottom loaded storage but less successful for top loaded storage. Using equations 2 and 3, results were similar to the bottom loaded storage model results reported by this reference. However, for top loaded storage, my model compared poorly to the reported results for the previously mentioned reference especially at short storage periods. Reported losses for the top loaded storage for the Farm A are based upon use of the barn floor model.

Based upon the above mentioned assumptions, measured manure and urine values for Farm A and Farm B, measured manure alley and bedded pack areas, and observed manure removal intervals, estimates of ammonia losses were made for all animal housing and manure storage facilities (Tables 3 and 4). It is estimated that between 12 and 14% of the nitrogen produced on Farm B is lost on the barn floor or during storage. This would appear to be between 29,000 and 35,000 pounds of nitrogen a year. For the Farm A, losses are estimated to be 15 to 17% of the nitrogen produced or 28,000 to 31,000 pounds of nitrogen. Because losses from the top loaded storage represent a significant part of the total losses from Farm A, I would suggest another effort be made at the model for top loaded storage as opposed to the assumptions I made.

Losses are temperature dependent as illustrated in Figures 3, 4 and 5. Outdoor temperature data for a near-by research farm was used. Barn floor temperature estimates needed by the models were assumed to be the same as outdoor temperatures with the exception that winter barn floor temperatures were not allowed to drop below freezing. Manure storage surface temperatures were assumed to be the same as outdoor temperatures. Wind speed also impacts volatilization losses. For outdoor manure storage, wind speed was assumed to be 50% of the wind speed reported at the research farm. For indoor storage and barn floors, a value of 0.7 miles per hour (1.1 kilometers per hour) was used as was done by Muck.

Figure 3. Ammonia volatilization losses for Farm B animal housing facilities as a function of time of year.

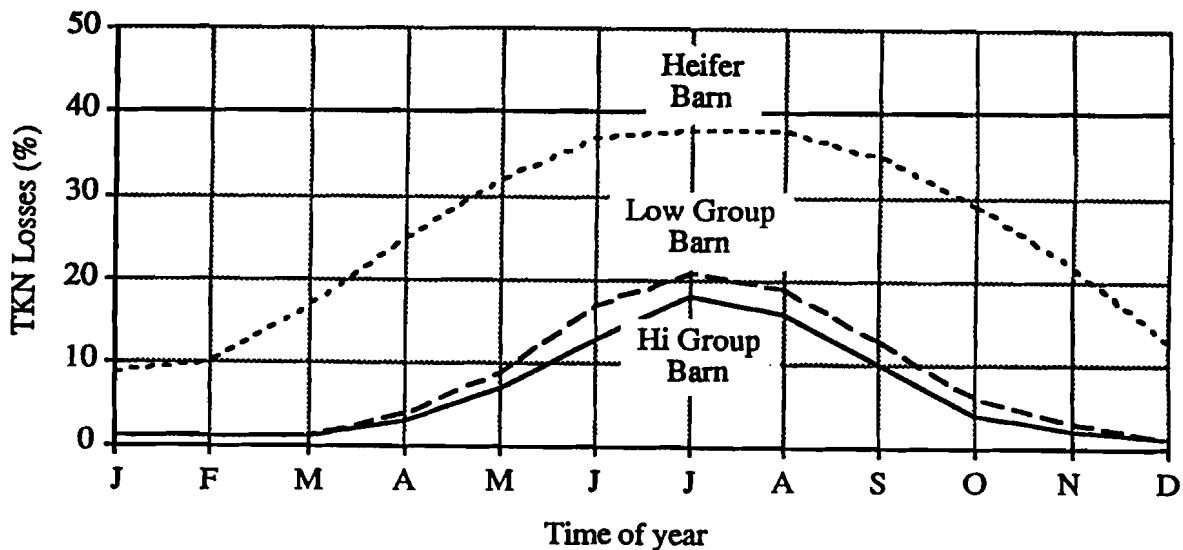

Figure 4. Ammonia volatilization losses for Farm B manure storage facilities as a function of time of year.

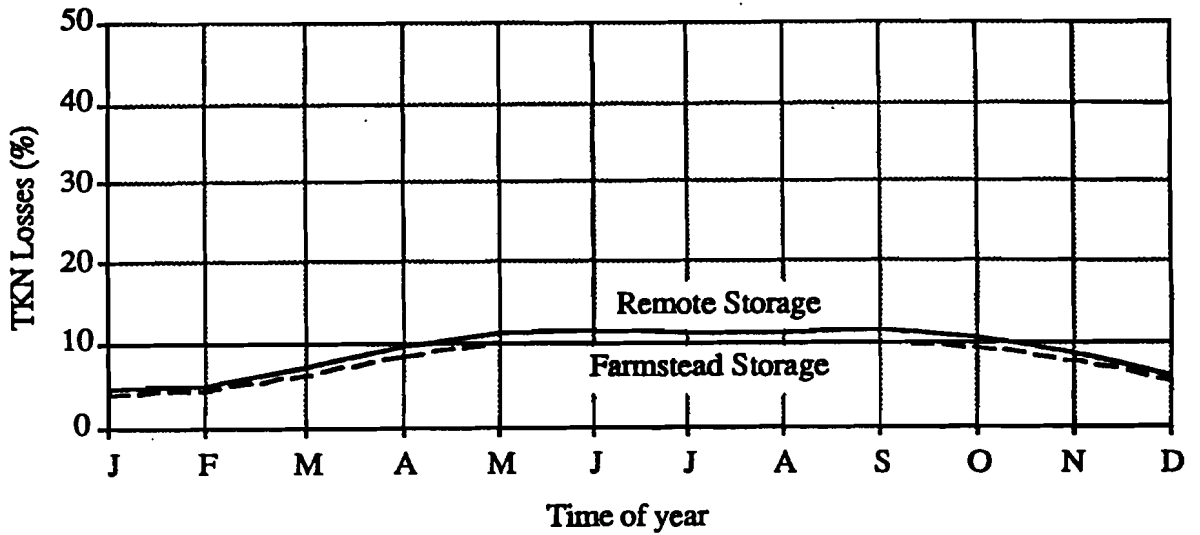
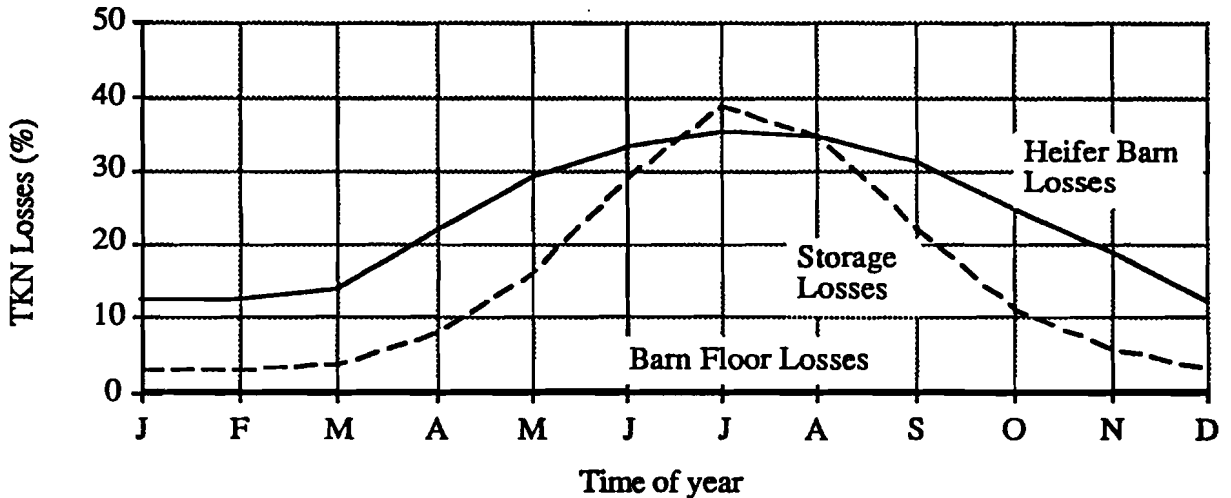

Figure 5. Ammonia volatilization losses for Farm A farm facilities as a function of time of year.



The value of these estimates for ammonia volatilization losses appear to be primarily academic. It helps define some of the differences in nitrogen inputs (feed, fertilizer and legume fixing) and outputs (meat and milk) from a farm and helps us better quantify at least those nitrogen inputs that are not lost to surface or ground water. If the intent of a farm's nutrient management program is to waste the ammonia fraction by not incorporating manure following land application (current practice on the case study farms), than knowledge of these losses is of little additional value beyond accounting for nitrogen flows. No changes in farm management are recommended if ammonia nitrogen is considered of value.

Treating ammonia nitrogen as a waste product has several advantages. Less acreage is required for land application if rates of application are nitrogen based. Wasting nitrogen as ammonia results in less risk of nitrogen contamination of waters leaving an individual farm. It also suggests that commonly implemented practices such as surface application of manure and daily scraping of manure from barns (or longer intervals) are acceptable.

If the intent of a nutrient management program is conserve ammonia nitrogen, then knowledge of barn floor and storage losses takes on added importance. Systems and management procedures for removing manure from the barn floor and holding it in storage will need to be reviewed in light of the potential nitrogen losses. Reduced residence time of manure on the barn floor and bottom loading of manure storage become important considerations in minimizing nitrogen losses.

Ammonia nitrogen conservation would also have certain advantages. Nutrient management practices based upon nitrogen will result in less buildup of P and K in soils because of the higher concentration of nitrogen in manure and the fewer gallons being applied per acre. This may often result in excess manure being available on many farms which might have some potential economic return if marketed. The requirement of soil incorporation for ammonia conservation should also have benefits in terms of reduced nutrient runoff potential and less odor nuisance. Lower ammonia releases to the air has advantages for air quality.

At this time, knowledge of ammonia volatilization losses on the two case study farms is important only for our purposes of accounting for nitrogen flows. Without ammonia nitrogen conservation being a priority for either farm, no changes in management practices are suggested.

Implications of Nutrient Management Plan Implementation

The implementation of a nutrient management plan on these two farms has some potential negative implications related to managing manure. Greater odor nuisance may accompany a nutrient management plan if additional manure storage is added or if more manure is applied in short periods of time as opposed to year round spreading of manure. The location of Farm A near a small town makes odor management an important consideration. Although Farm B has fewer neighbors, the farm owner suggests that odor is still an important issue. Nutrient management plans also encourage greater applications of manure in the spring and late fall when row crops are not in place. Manure applications during these periods are often on wetter soils where compaction and runoff risks are increased. Finally, plans which encourage greater applications of manure, in the spring and late fall for efficient nutrient utilization shortens the window for manure application. The most obvious impact is upon labor and equipment needs.

Table 3. Ammonia volatilization losses from barn floor and storage for Farm B as estimated by computer model.

Location	Animals	Manure Production lb/d	Scraping Interval Assumed	Nitrogen				
				Initial Conc. (%)	Final Conc. (%)	Production lb/yr	Loss	
							lb/yr	%
New Milking Herd Barn	280	52,000	8h	0.70%	0.66%	133,000	8500	6%
Old Milking Herd Barn	170	26,600	8h	0.68%	0.62%	66,100	5,400	8%
Bred Heifer Barn	150	9,900	5d	0.58%	0.43 to 0.49%	20,900	3400 to 5600	16 - 27%
Dry Cow Barn	85	6800		0.58%		14,400		20 - 30%
• Manure alleys			5d		0.41 - 0.47%		2000 to 3100	
• Bedded packs			30d		0.38 - 0.44%		900 to 1200	
Replacement Herd Barn	210	9000		0.58%		19,100		20 - 30%
• Manure Alleys			5d		0.42 - 0.48%		1700 to 2700	
• Bedded packs			30d		0.40 - 0.45%		2100 to 3100	
Farmstead manure storage							3100	12%
Satellite manure storage							2200	11%
Total		104,300				253,500	29,300 to 34,900	12 - 14%

Table 4. Ammonia volatilization losses from barn floor and storage for Farm A as estimated by computer model.

Location	Animals	Manure Production lb/d	Scraping Interval Assumed	Nitrogen				
				Initial Conc. (%)	Final Conc. (%)	Production (lb/yr)	Loss	
							lb/yr	%
Milking Barn	280	48,800	0.67hr	0.84%	0.84%	149,600	200	0%
Dry Cow/Bred Heifer Barn	78	6600	2x/week	0.58%	0.45 to 0.50%	14,100	1900 to 3200	13 - 22%
Heifer Barn	150	9000	2x/week	0.58%	0.45 to 0.50%	19,100	2700 to 4500	14 - 24%
Calf Barn	40	800				2550		25 - 33%
• Manure alley			2x/week	0.58	0.39 to 0.43%		200 to 270	
• Bedded Pack			30d	0.58	0.39 to 0.43%		430 to 570	
Storage				0.84			22,400	15%
Total		65,200				185,000	27,800 to 31,100	15% - 17%

As the case study farms are encouraged to adopt practices that will more efficiently manage the nutrient resources of manure, parallel planning is needed for systems that will avoid the previously mentioned problems. The following principles in planning a manure handling and application system compatible with nutrient management planning should be considered:

1. *Move manure by continuous systems rather than batch systems.* Slurry tankers are inefficient in their use of labor, slow in their movement of manure, and excellent compactors of the soil. Systems capable of continuously moving manure at rates of 500 gallons a minute or more are attractive for moving the large quantities of manure produced by larger dairies in the narrow time windows available.
2. *Move manure as close to point of application as possible year round.* Manure storages at the farmstead are often an odor nuisance and eyesore for the farm owner and neighbors. Moving manure from the barn to as close to the point of use as possible should be a year round task that makes use of labor and equipment needs during periods of low to moderate demand. Remote storage centered within the crop land and possibly at multiple locations should be considered as opposed to one storage next to the barn.
3. *Produce pumpable slurry by removing solids ... not adding water.* Dilution water additions account for 40 to 50% of the investment in equipment and labor for handling manure on the case study farms. Water additions should be minimized. Where handling manure as a slurry is preferred, solids separation may be a less expensive means of producing the desired slurry. Solids separation will also produce a more uniform and pumpable slurry than the addition of dilution water.
4. *Apply manure with immediate shallow incorporation or low trajectory surface application systems.* Shallow incorporation or low trajectory application that avoid mixing of air and manure will be the simplest method of controlling odors. Incorporation will be valuable to reducing runoff risks. Over the last few years several alternatives have become available commercially or assembled by innovative farmers.
5. *Design distribution systems that encourage even distribution of manure nutrients.* Manure application equipment has historically been designed as disposal equipment, not as fertilization equipment. Even application of manure was not an important consideration in equipment design. Nutrient management planning failures may often be a result of equipment and equipment operator failures to distribute nutrients as evenly as is expected with fertilizer equipment. Manure application equipment will need to be selected for its demonstrated ability to provide even application across the spread pattern. Knowledge of one's current equipment spread pattern and appropriate overlapping of spread pattern applications to compensate for uneven patterns will be important operator considerations.

References

- ASAE. 1992. Manure production characteristics. p. 484-486. *In* 1992 ASAE Standards. ASAE, St. Joseph, MI.
- NRAES. 1994. Liquid manure application systems. Proceedings from the liquid manure application systems conference. December 1 and 2, 1994. NRAES, Ithaca, NY.
- Morse, D., R. A. Nordstedt, H. H. Head, EL H. Van Horn. 1994. Production and characteristics of manure from lactating dairy cows in Florida. *Transactions of the ASAE* 37:275-279.
- Muck, R. E. and T. S. Steenhuis. 1982. Nitrogen losses from manure storage. *Agricultural Wastes* 4:41-54.
- Muck, R. E. and B. K. Richards. 1983. Losses of manurial nitrogen in free-stall barns. *Agricultural Wastes* 7:65-79.
- Muck, R. E. 1982. Urease activity in bovine feces. *J. of Dairy Sci.* 65:2157-2163.
- Muck, R. E. and T. S. Steenhuis. 1981. Nitrogen losses in free-stall dairy barns. p. 406-409. Presented at the fourth international symposium on livestock waste.
- Van Horn H. H. 1991. Achieving environmental balance of nutrient flow through animal production systems. *The Professional Animal Scientist* 7(3):22-33.

**Integrating Knowledge to Improve Dairy Farm
Sustainability - Part VI:**

**Measuring Nutrient Loads From a Drainage Basin
Within the Farm Boundaries**

J. B. Houser, R. E. Pitt, J. L. Hutson, and P. E. Wright

ABSTRACT

A water monitoring program was conducted on Farm A in which actual leaching and runoff of nutrients were measured by identifying and delineating an area drained by a single stream (i.e. a drainage basin) and monitoring the concentrations of nitrate-nitrite-Nitrogen (N), phosphorus (P) and total solids in the stream. The selection of the site was critical to the accuracy of the measurements. To measure runoff and leachate (i.e. groundwater flow) from a single drainage basin, it was necessary to monitor a stream which drains the whole basin. The geohydrology of the area indicated that the small stream which drains the sampling site selected was not charged by any subsurface flows other than that which leaches through or runs off the delineated drainage basin. Therefore, there should be no nutrient inputs external to the study site impacting the streamflow, nor significant loss of nutrients to external sinks or deep seepage other than the measured stream.

A V-notch weir with a mechanical float streamflow monitor provided by the United States Geological Service (USGS) was used to measure streamflow. An ISCO sampler collected continuous composite samples of water from the stream every 90 minutes to be analyzed for total P, nitrate-nitrite-N and total solids. The weir and streamflow monitor were installed the last week in April 1995. Between the period of 4/26/95 and 11/22/95, the total streamflow was 120×10^3 cubic feet. The total mass of nitrate-nitrite-N, total P and total solids in the stream flows was 106 lb, 3.0 lb and 4.6 tons respectively. Average concentrations were 14.4 ppm nitrate-nitrite-N, 0.41 ppm total P and 0.13 % total solids. Though there is not enough data to estimate the annual loading or annual average concentration of the measured nutrients the data show that at certain times during the year nutrient concentrations leaving the farm in streamflow may be significant. In October, the average concentrations were 18.8 and 0.52 ppm for nitrate-nitrite-N and total P, respectively. In November, the average concentrations were 113.4 and 0.38 for nitrate-nitrite-N and total P, respectively. The nitrate-nitrite-N amounts are above the EPA standards of 10 ppm. Also, total P is much higher than the 0.1 ppm pollution standard but within the usual range of concentrations in agricultural fields (0.05 to 1.1 ppm). How this data can be related to the entire farm and to the off-farm environment needs to be investigated further.

INTRODUCTION

Various modeling efforts have been employed on the case farms to determine the quantities and concentrations of nutrients that may be passing through the farms and into the off-farm environment. To validate these models, actual leaching and runoff of nutrients from an area within Farm A were measured by identifying and delineating an area drained by a single stream (i.e. a drainage basin) and monitoring the concentrations of nitrate-nitrite-N, phosphorus and total solids in the stream.

MATERIALS AND METHODS

Site Selection

To measure runoff and leachate (i.e. groundwater flow) from a single drainage basin, it is necessary to monitor a stream which drains the basin. Two criteria for the stream had to be met: 1) that it was not fed from sources outside the farm, and 2) that it adequately captured all the runoff and leachate from the fields within the drainage basin.

To help ensure that the nutrients measured would only be resulting from the farm field and not from sources beyond the farm, it was necessary to identify a stream which originated from within the farm boundaries and which was not fed by any outside sources. Characteristics of such a stream would be 1) that its inception would actually be at the edge of the field to be monitored, and 2) that it would be an ephemeral stream, i.e. that during periods of dry weather when there was no leaching or runoff, the stream would dry up, indicating that it was not being fed by any underground streams, springs or saturated zones which cross the delineated boundaries of the drainage basin.

Ideally, in order to accurately gauge the amounts of nutrients leaving the field and escaping into the off-farm environment, the stream should also receive virtually all of the runoff and leachate from the drainage basin. In other words, water which leaches from the field should not leach deeply into the ground causing a base flow of a deeper saturated zone which might cross drainage basin boundaries, effectively bypassing the monitored stream.

Using USGS contour and stream maps of the case farms, likely sites were identified and then visited. An ideal site was found on Farm A. A small ephemeral stream, which led off the farm, originated at the edge of a farm field and drained a relatively small series of tile-drained fields. Based on observations of stream banks and stream channel, the normal flow of the stream was estimated to be less than 7 cubic feet per second (cfs) ($0.2 \text{ m}^3/\text{sec}$) with a potential flood stage flow of up to 52 cfs ($1.5 \text{ m}^3/\text{sec}$).

The fields in the drainage basin were composed of Kendaia and Lima series soils which are shallow, poorly drained soils. About a meter deep in these soils is a hardened, cemented calcium pan which acts much like a fragipan. The pan has a very low hydraulic conductivity (about 1 mm/day) which effectively prevents water from leaching into deeper aquifers. For this reason the fields were poorly drained and tile-drains had been installed to eliminate saturated conditions. The presence of a pan, along with the installed tile-drains which empty into the stream, suggests that the majority of water which leaches through these soils will end up in the monitored stream.

Surface delineation of a drainage basin was difficult due to the gently sloping nature of the farm (most slopes less than 5%); however, using a map of the tile-drains from the farm archives, on-site inspections with the farmer, and some surveying, the area drained was determined to be about 42 acres (17 ha), and encompassed fields planted in corn, alfalfa, and grass.

Stream Monitoring

To measure the total mass of nutrients leaving the field it is necessary to monitor 1) total streamflow (volume of water per time) and 2) concentrations of nutrients in the streamflow. The stream site was inspected by Dave Eckhart from the United States Geological Service (USGS). Due to the flat terrain which created very slight drops in elevation along the stream, a weir was considered a more appropriate streamflow measuring device than a Parshall flume.

A weir essentially acts as a dam which allows the stream to pass only through a constructed opening of known dimensions. The height of the water in this opening then can be

related to streamflow through an appropriate function. A separate device is required to measure and record the actual height of the stream. For this project a modified 90° V-notch weir with a squared upper portion was used to capture potentially large flows. A 90° V-notch weir has favorable accuracy at shallow depths and low streamflows of 0.02 to 2 cfs (0.0006 to 0.06 m³/sec) or lower, and discharges can be measured within 3% accuracy. The flow relationship is:

$$\text{Flow} = C \cdot h^{2.5} \quad (1)$$

where

Flow = streamflow in cfs

h = height in feet above the bottom of the V-notch

C = a constant

C is determined by measuring the flow at various heights; but in the absence of such a rating, a value of 2.47 can be used. Ideally to determine C, a series of low flows and high flows are required. Low flows were measured and compared to the equation using a C value of 2.47. Predictions matched actual measurements very closely. To this date there have been no consistently high flows which could be measured. A value of 2.47 has been used for all calculations.

Due to the flat terrain of the basin and stream, the streambed has neither steep nor high banks, which made construction of the weir problematic. Transections of a number of sites along the streambed were taken to find an area with as high a bank as possible on both sides of the stream. A site was found with a 2.5 foot (0.76 m) bank proximate to the stream; the other bank rose to a similar elevation 39 feet (12 m) from the stream. Therefore, one edge of the weir was embedded into the side of the steep bank, and a 2 foot (0.62 m) high, 39 foot long pressure treated plywood wall was built on the opposite bank to contain the stream and channel it all through the weir.

The weir itself was constructed from a 4x8 ft, 3/4 inch sheet of marine plywood with the V-notch cut into it. The notch itself was lined with beveled stainless steel in order to create the fine edge necessary for accurate low-flow measurements. The weir was secured in place by burying it two feet deep into the streambed and pouring concrete around its foundation. In addition, support braces were used. A similar method was used to secure the wall.

A mechanical float in a stilling well located upstream of the weir was used to graph a continual record of stream height versus time on a rotating drum chart. The stilling well was a 5 foot piece of 10 inch PVC pipe, with the mechanical stream flow monitor mounted on top. Holes were drilled along the length of the PVC to allow the stream to enter the well. The well was also secured in the streambed with concrete. The mechanical float gave a continual reading of the height of the stream above the V-notch, which was converted to streamflow by equation 1.

Both the weir and streamflow monitor were installed during the last week of April 1995. Weekly rainfall data were also collected at the site to confirm daily rainfall records from a nearby Farm Research Weather Station.

Nutrient Concentrations. To determine the actual load of nutrients in the stream, streamflow must be multiplied by the concentration of nutrients in that streamflow. An ISCO continuous sampler was installed on 5/5/1995 and used to collect 25 ml water samples from the stream every 90 minutes. Such frequent sampling was done in order to capture all significant streamflow events; this is important because studies have shown that a majority of nutrients lost *could be contained in a single streamflow event*. Every 16 samples were composited into single daily samples. Before 5/5/95, a single grab sample represented the daily sample. To prevent oxidation of nitrogen after collection, samples were preserved by treating sample collection bottles with 1 ml concentrated HCl per 100 ml of sample. Samples were then refrigerated. Samples were analyzed by the Cornell Nutrient Analysis Laboratory. The precision of the analysis was tested by a series of duplicates submitted with each analysis, and by independent testing of selected samples in the Department of Agricultural and Biological Engineering. Samples have been tested for (nitrate-nitrite-nitrogen), total phosphorus, and total solids.

Streamflow

There have been only four months which exhibited streamflow since the weir was installed. One period was from 4/26/95 (date of installation) until 5/22/95. There was no additional streamflow until 10/21/95. Streamflow continued until some time around 12/13/95 when the stream froze, and then returned around 1/19/96 during a thaw. Figure 1 shows the streamflow during the first period from 4/26/95 to 5/22/95. Figure 2 shows the streamflow from 10/1/95 to 11/22/95 (the last streamflow event for which analysis of samples has been performed). Each figure shows streamflow in cfs versus time, with daily precipitation amounts in inches from the weather station closest to the site.

As can be seen in Figure 1, there was streamflow at the time of installation, though very little (about 0.002 cfs [$5.7 \times 10^{-5} \text{ m}^3/\text{sec}$]). A large rainfall event of over 0.4 inches (1 cm) in early April created a sudden increase in streamflow, followed by a rapid decrease of streamflow leveling out to a low flow until streamflow ceased around May 7. Rainfall events around May 10 reestablished the stream flow, but only for a short period. There was no additional streamflow until fall.

It was an unusually dry summer, reaching near drought conditions in the area, and the stream remained dry all summer. As can be seen in Figure 2, streamflow returned in late October when evapotranspiration was low enough to allow a buildup of soil moisture. Notice that the streamflows exhibited here are much higher than the streamflows measured at the end of the spring, where the significant streamflow event was only 0.02 cfs ($5.7 \times 10^{-4} \text{ m}^3/\text{sec}$) and the majority of time, streamflow was less than 0.003 cfs ($8.5 \times 10^{-5} \text{ m}^3/\text{sec}$) (Fig 1). The first event in October peaked at over 0.5 cfs ($0.014 \text{ m}^3/\text{sec}$), and when streamflow returned, it was usually over 0.1 cfs ($0.0028 \text{ m}^3/\text{sec}$).

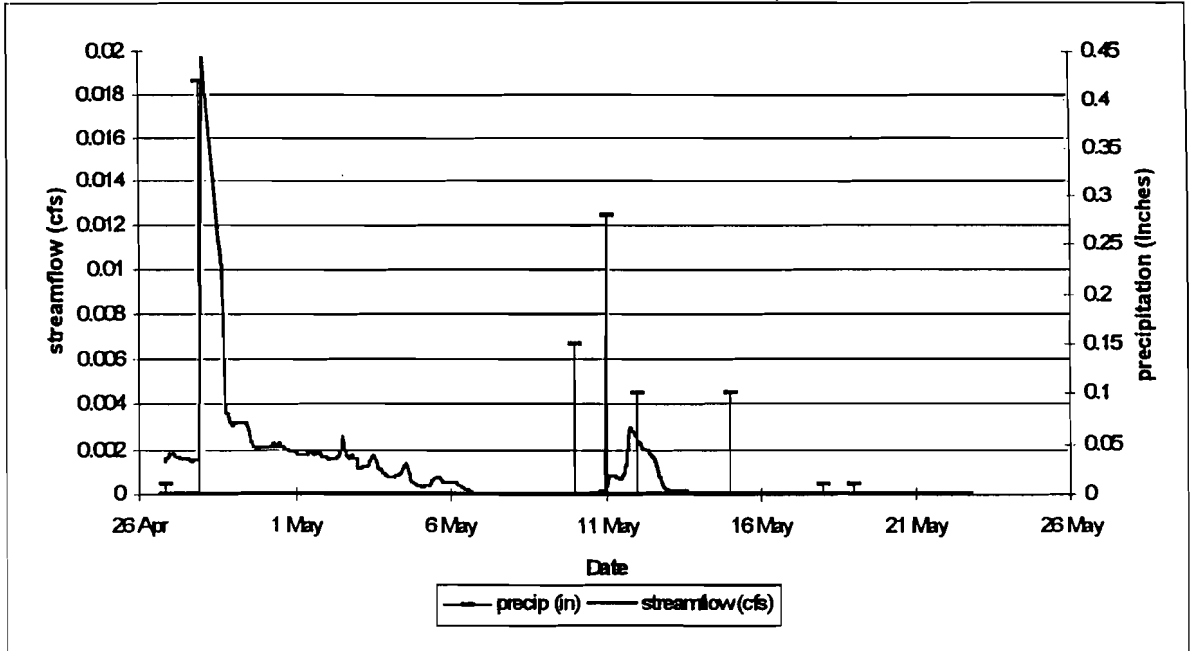

Fig. 1: Measured streamflow in cubic feet per second (cfs) from the Farm A drainage basin, and precipitation as recorded at the Aurora Farm Research Station 4/26/95 - 5/26/95

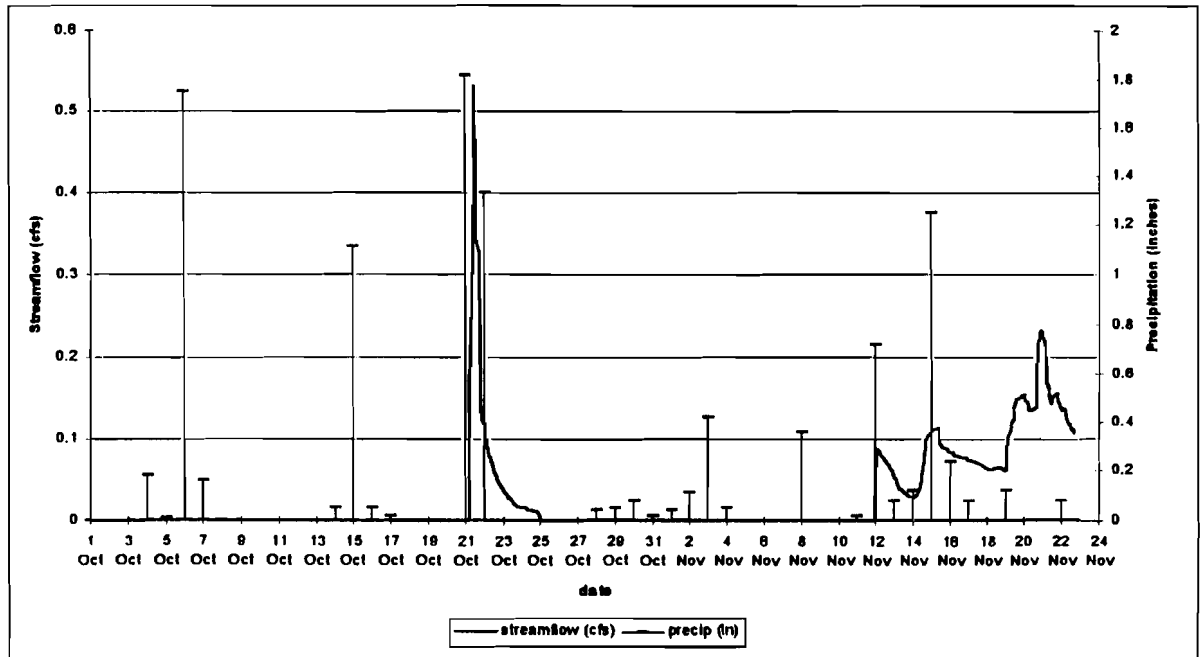

Fig. 2: Measured streamflow in cubic feet per second (cfs) from the Farm A drainage basin, and precipitation as recorded at the Aurora Farm Research Station 10/1/95 - 11/22/95

As can be seen in Figure 2, significant rainfall events (over an inch) in the beginning of the month did not result in streamflow due, apparently, to dry soil conditions. It was only when soil moisture had been built up sufficiently that streamflow returned. Figure 2 shows that the rainfall event of October 21 resulted in the return of the stream. A peak of streamflow around October 21 was followed by a gradual decrease to zero flow over 3 to 4 days. The 3 to 4 day period of decrease graphically illustrates the concept of field capacity, which is the soil moisture content at which gravity no longer causes any moisture to drain from the soil. Practically, this is determined by measuring soil moisture of a field 3 to 4 days after a rainfall event, because this is the amount of time considered necessary for the average field to drain completely. The first streamflow event of Figure 2 illustrates this phenomenon of soil drainage.

Streamflow returned on November 12, and continued until mid-December when the stream froze. On 1/19/96 there was a major snow melt and precipitation event which created a very large streamflow. The stream overflowed the weir by about 1.5 inches (3.8 cm), but did not overflow the banks or constructed wall and bypass the weir. Water samples for all these events were collected and samples up to 11/22/95 have been analyzed.

The total streamflow measured from April 26, 1995 to November 22, 1995 was 118×10^3 ft³ (3343 m³) (Table 1). Based on an area of 42 acres (17 ha), this would give a total streamflow of about 0.79 inches (2 cm).

Nutrients

Figure 3 shows streamflow and the daily composited concentrations of nitrate-nitrite-N in parts per million (ppm) for the period of 4/26/95 to 5/22/95. Initial nitrate concentrations were low (around 0.35 ppm) and steadily decreased with decreasing streamflow, until they reached zero, where they remained, even when streamflow returned for a short period on May 11 through 16 (the limit of detection for the nitrate test is 0.05 ppm so values reported as zero may have trace amounts of nitrate < 0.05 ppm).

Figure 4 shows streamflow and the daily composited concentrations of total phosphorus (ppm) and total solids (%) for the period of 4/26/95 to 5/22/95. Phosphorus and total solids are graphed together because the majority of phosphorus in streamflow is usually carried on soil particles (Dunne and Leopold, 1978). Figure 4 shows that phosphorus concentrations went up after the initial spike of streamflow around April 28, as did the solids. Phosphorus concentrations then came down as the streamflow ended, increasing a bit during the next spike of streamflow but not approaching the levels of the previous event. Solids concentrations, however, did increase significantly at the end of the first streamflow event, around May 8, and during the second streamflow spike of May 11 through 16.

As mentioned previously, most phosphorus is adhered to soil particles, so there should be a correlation between solids concentration and phosphorus. Such a pattern can be seen in Figure 4. To illustrate the covarying trends of the two concentrations, it is possible to break the time into two periods and examine each one separately. If just the grab samples before May 5 are correlated there is a correlation coefficient of 0.72. There is a smaller correlation coefficient after May 5 of 0.41. However, if the one aberrant point of May 14 is removed the correlation coefficient increases to 0.74.

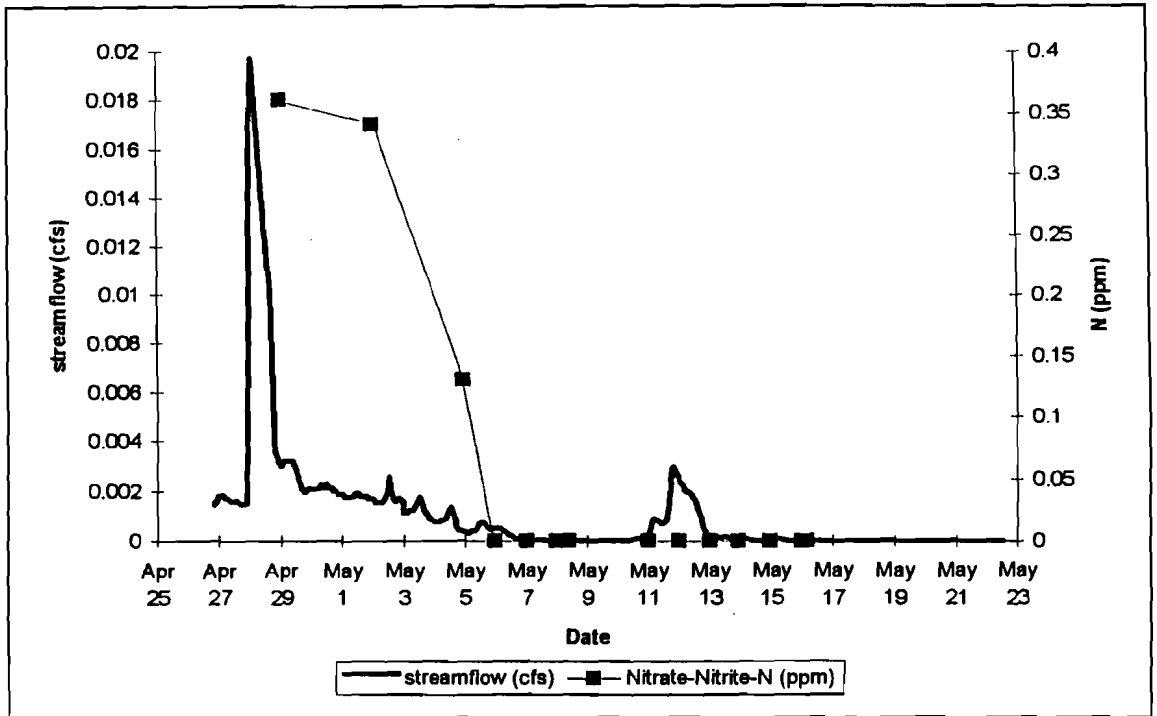

Fig. 3: Streamflow in cubic feet per second (cfs) and Nitrate-Nitrite-N concentration in streamflow from Farm A drainage basin 4/26/95 - 5/26/95

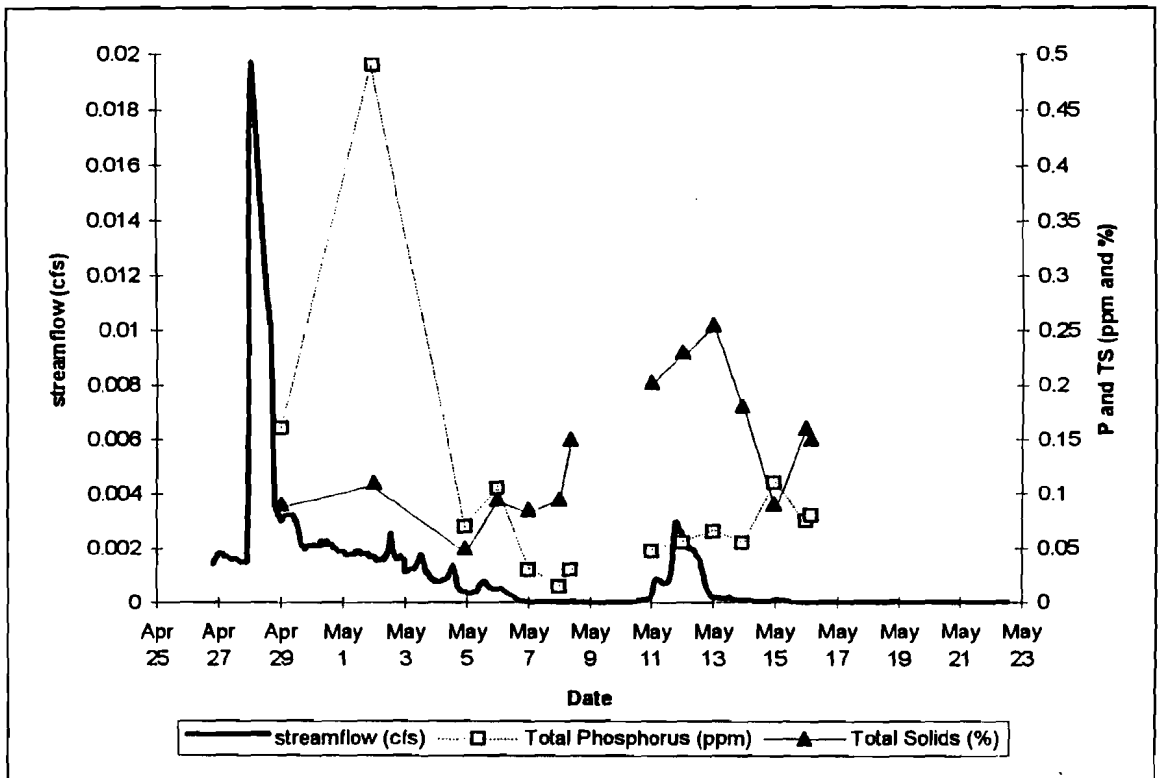

Fig. 4: Streamflow in cubic feet per second (cfs), Total Phosphorus (ppm), and Total Solids (%) concentration in streamflow from Farm A drainage basin 4/26/95 - 5/26/95

Figure 5 shows streamflow and the daily composited concentrations of nitrate-nitrite-N (ppm) for the period of 10/1/95 to 11/22/95. As streamflow began for the first time since the previous May, the nitrate concentration was quite high (around 15 ppm). Concentrations increased to almost 25 ppm as the first streamflow event subsided, but then began to decrease as the flow ceased. Nitrate concentrations continued to steadily decrease over time in the second streamflow event while streamflow increased.

Figure 6 shows streamflow and the daily composited concentrations of total phosphorus (ppm) and total solids (%) for the period of 10/1/95 to 11/22/95. With the very first peak of streamflow, phosphorus concentrations were high (around 0.7 ppm), but then rapidly decreased as streamflow decreased. As the second streamflow event began on November 12, phosphorus concentrations were at approximately the level they were when the first streamflow event ended (around 0.15 ppm). However, they increased as streamflow increased. There was a sudden increase of concentration with each new spike of streamflow, followed by a decrease in concentration, but with an overall trend of increasing concentration. The final recorded concentration was higher than the initial concentration of the first streamflow event. This is markedly different than the consistently steady decreasing trend of nitrate concentration shown in Figure 5.

The correlation between phosphorus and total solids is not as evident in Figure 6 as in Figure 4. The correlation coefficient of all the total solids concentrations with phosphorus concentrations is only 0.16. The first event has a negative correlation coefficient of -0.16. The last streamflow event has a correlation coefficient of 0.21.

Table 1 shows the total mass loading of nitrate-nitrite-N, phosphorus, and solids, as well as total streamflow. These amounts were computed by taking the daily composited concentrations and multiplying them by the total amount of recorded daily streamflow, and then summing over all days. Total solids can be taken as an indication of sediment yield from the drainage basin. For the currently measured period, the total mass of solids in the streamflow was 4.6 tons (4.2 Mg), or about 0.11 tons/acre (0.25 Mg/ha) based on a 42 acre (17 ha) drainage basin. Acceptable soil loss tolerances range from 0.5 to 4.9 tons/acre (1 to 11 Mg/ha) (Pierce et al., 1983). However, for this area the acceptable range is 3 to 5 tons/acre/yr (7 to 12 Mg/ha/yr) (Rossing, 1995).

Table 2 shows the average concentration of nitrate-nitrite-N, total phosphorus, and total solids in the recorded streamflow events. They were computed by taking the total mass and dividing it by the total streamflow.

The EPA standard for nitrate-N in the groundwater is 10 ppm. Nitrates are held only loosely in soils, and are easily leached to the groundwater (Dunne and Leopold, 1978). Therefore, the concentrations of nitrate in Table 2 can be interpreted as groundwater concentrations. These data are only preliminary, because the actual average concentration from this drainage basin would need to include several years monitoring.

Phosphorus is the nutrient most often considered responsible for eutrophication, or algal blooms in surface waters. According to Dunne and Leopold (1978), most uncontaminated streams have less than 0.03 ppm of total phosphorus. A concentration of greater than 0.1 ppm is considered high. Dunne and Leopold (1978) report the range for usual concentrations in discharge from agricultural fields is 0.05-1.1 ppm. Therefore, the concentration in Table 2 is within the expected range.

Figure 5 shows streamflow and the daily composited concentrations of nitrate-nitrite-N (ppm) for the period of 10/1/95 to 11/22/95. As streamflow began for the first time since the previous May, the nitrate concentration was quite high (around 15 ppm). Concentrations increased to almost 25 ppm as the first streamflow event subsided, but then began to decrease as the flow ceased. Nitrate concentrations continued to steadily decrease over time in the second streamflow event while streamflow increased.

Figure 6 shows streamflow and the daily composited concentrations of total phosphorus (ppm) and total solids (%) for the period of 10/1/95 to 11/22/95. With the very first peak of streamflow, phosphorus concentrations were high (around 0.7 ppm), but then rapidly decreased as streamflow decreased. As the second streamflow event began on November 12, phosphorus concentrations were at approximately the level they were when the first streamflow event ended (around 0.15 ppm). However, they increased as streamflow increased. There was a sudden increase of concentration with each new spike of streamflow, followed by a decrease in concentration, but with an overall trend of increasing concentration. The final recorded concentration was higher than the initial concentration of the first streamflow event. This is markedly different than the consistently steady decreasing trend of nitrate concentration shown in Figure 5.

The correlation between phosphorus and total solids is not as evident in Figure 6 as in Figure 4. The correlation coefficient of all the total solids concentrations with phosphorus concentrations is only 0.16. The first event has a negative correlation coefficient of -0.16. The last streamflow event has a correlation coefficient of 0.21.

Table 1 shows the total mass loading of nitrate-nitrite-N, phosphorus, and solids, as well as total streamflow. These amounts were computed by taking the daily composited concentrations and multiplying them by the total amount of recorded daily streamflow, and then summing over all days. Total solids can be taken as an indication of sediment yield from the drainage basin. For the currently measured period, the total mass of solids in the streamflow was 4.6 tons (4.2 Mg), or about 0.11 tons/acre (0.25 Mg/ha) based on a 42 acre (17 ha) drainage basin. Acceptable soil loss tolerances range from 0.5 to 4.9 tons/acre (1 to 11 Mg/ha) (Pierce et al., 1983). However, for this area the acceptable range is 3 to 5 tons/acre/yr (7 to 12 Mg/ha/yr) (Rossing, 1995).

Table 2 shows the average concentration of nitrate-nitrite-N, total phosphorus, and total solids in the recorded streamflow events. They were computed by taking the total mass and dividing it by the total streamflow.

The EPA standard for nitrate-N in the groundwater is 10 ppm. Nitrates are held only loosely in soils, and are easily leached to the groundwater (Dunne and Leopold, 1978). Therefore, the concentrations of nitrate in Table 2 can be interpreted as groundwater concentrations. These data are only preliminary, because the actual average concentration from this drainage basin would need to include several years monitoring.

Phosphorus is the nutrient most often considered responsible for eutrophication, or algal blooms in surface waters. According to Dunne and Leopold (1978), most uncontaminated streams have less than 0.03 ppm of total phosphorus. A concentration of greater than 0.1 ppm is considered high. Dunne and Leopold (1978) report the range for usual concentrations in discharge from agricultural fields is 0.05-1.1 ppm. Therefore, the concentration in Table 2 is within the expected range.

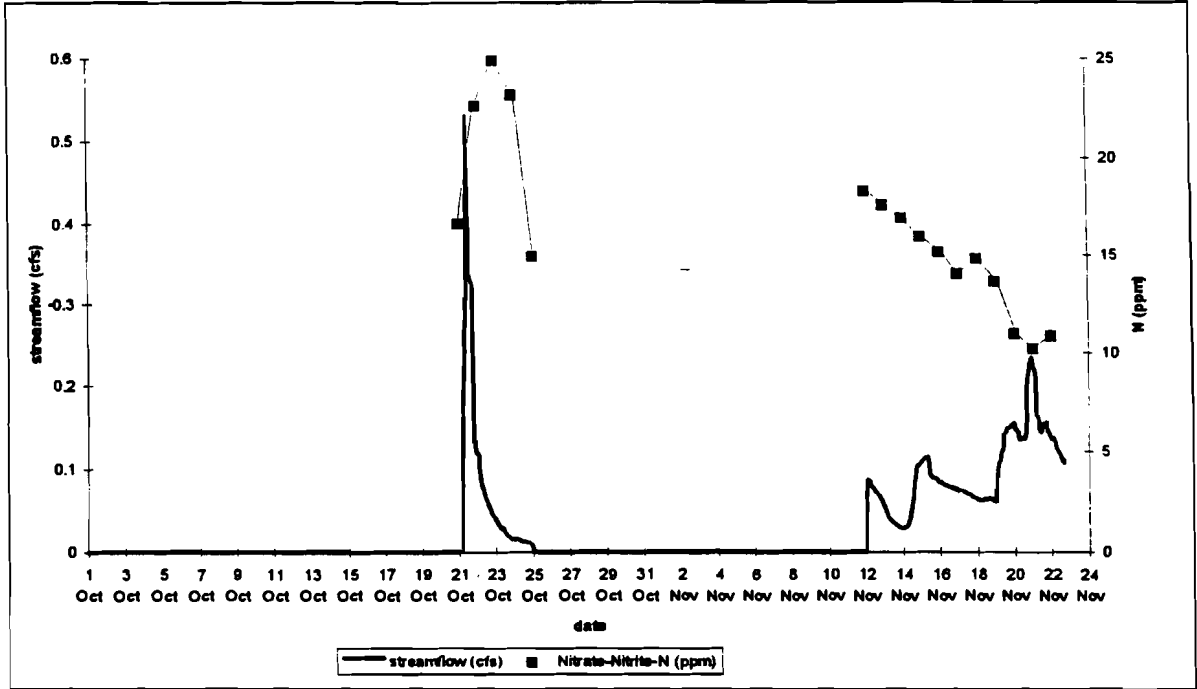

Fig. 5: Streamflow in cubic feet per second (cfs) and Nitrate-Nitrite-N concentration (ppm) in streamflow from Farm A drainage basin 10/1/95 - 11/22/95

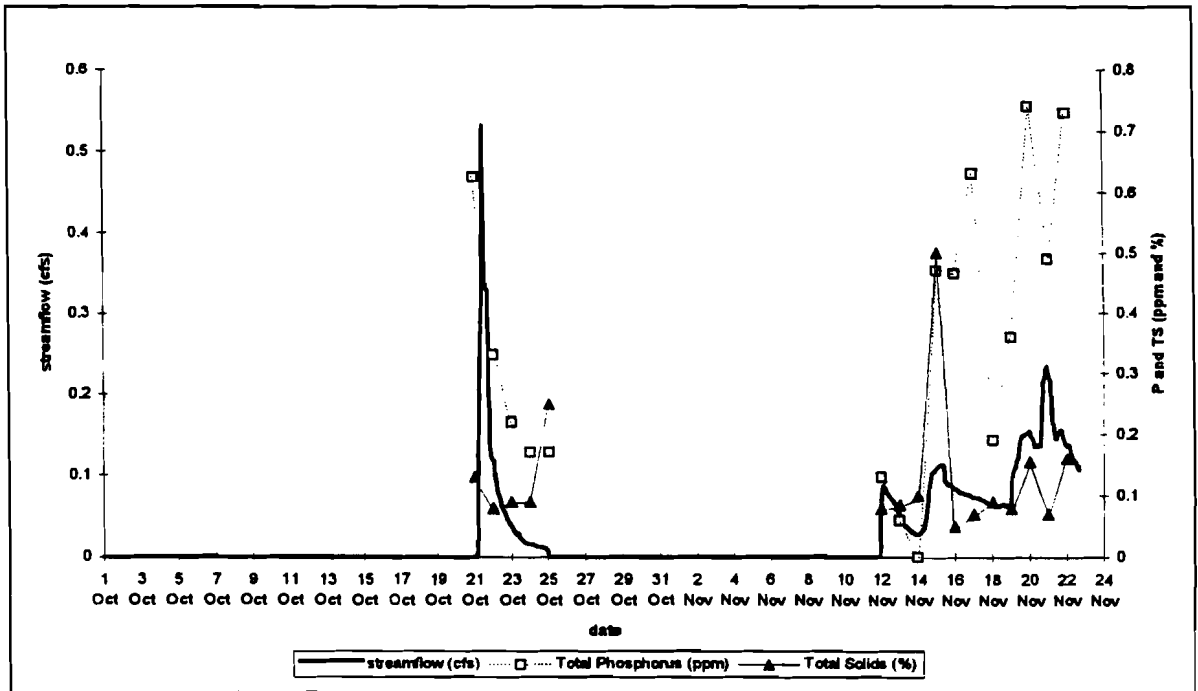

Fig. 6: Streamflow in cubic feet per second (cfs), Total Phosphorus (ppm), and Total Solids (%) concentration in streamflow from Farm A drainage basin 10/1/95 - 11/22/95

Table 1: Total streamflow and total mass of Nitrate-Nitrite-N, Phosphorus, and Total Solids in Farm A drainage basin streamflow from April 26 to November 22, 1995

date	Total Streamflow 1 x 10 ³ ft ³	NO ₃ -NO ₂ -N lb	Total P lb	Total Solids tons
4/26 - 5/22/95	2.4	0.05	0.03	0.08
10/21 - 10/25/95	27.4	32.1	0.88	0.98
11/12 - 11/22/95	88.3	73.9	2.09	3.59
Totals	118.1	106.1	3.00	4.65

Table 2: Average concentration in parts per million of Nitrate-Nitrite-N, Phosphorus, and Total Solids in Farm A drainage basin streamflow from April 26 to November 22, 1995

NO ₃ - NO ₂ - N ppm	Total P ppm	TS ppm	TS %
14.4	0.41	1265.2	0.13

DISCUSSION

Figure 1 and Table 1 show that the amount of streamflow recorded in the spring of 1995 was almost insignificant, amounting to about 2 % of the total measured flow. Therefore, the concentrations of nitrate-nitrite-N, P, and total solids were very low, as would be expected at the end of a long period of flushing. There are not enough data to derive any conclusions about the nutrient loading which occurred that spring. The streamflow event of late fall 1995 (Fig. 2) was more significant, however, as it is the first flushing of the fields after an entire summer of cultivation and crop growth with fertilizer and manure additions.

Though there are not enough data to estimate the yearly loading or average concentration of the measured nutrients, it can be seen from Tables 1 and 2 that at certain times during the year nutrient concentrations leaving the farm in streamflow may be significant. These data should be related to the entire farm and to the off-farm environment and needs to be investigated further.

Based on some preliminary modeling with the Generalized Watershed Loading Function (GWLf) (Haith et. al., 1992), a streamflow and erosion model, the measured streamflow values were low (0.79 in [2 cm]) for the size of the assumed drainage basin. Part of the delineated drainage basin was a field connected to the stream by a single tile-drain. No runoff from this field would reach the monitored stream, and it is questionable how much of the field was drained by this single tile-drain, or how much of that tile-drain actually reached the stream, as it is the field most distant from the stream's inception. If that field were eliminated, the drainage basin would be only 30 acres (12 ha), and the streamflow would be 1.1 in (2.8 cm). The model predicts a streamflow of about 3.9 in (10 cm) and about 5.5 to 22 tons (5 to 20 Mg) of sediment loss depending on the variables used and the size of the catchment assumed, compared to the measured value of 4.6 tons (4.2 Mg) for total solids in the streamflow. However, total solids measurement may not be a very accurate determination of field erosion due to many factors such as deposition and stream bank and streambed contributions (Walling, 1988).

Our preliminary assessment is that the drainage basin we have delineated was larger than that which actually drains into the stream during some runoff events. However, it may also be that more water is being leached to deep zones and by-passing the stream, or that we are overestimating the amount of runoff, since the areas which contribute most of the runoff in the model were actually separated from the stream by a grass field over 100 yds wide. Also, based on observation after the January 1996 runoff event, some of the runoff, at least during high flow, was shunted into another runoff channel which by-passes the measured stream. If runoff is subtracted from streamflow, then total simulated streamflow is only about 2.8 in (7 cm).

These uncertainties make a mass balance or model validation difficult. Further effort will focus on identifying the boundaries of the drainage basin which feeds the monitored stream. However, if it can be assumed that most streamflows originating within the farm from agricultural fields would have similar concentrations to the monitored stream regardless of drainage basin size, the data on concentrations may help in giving a sense of the environmental impact of the farming operation at certain times of the year, or during certain events. Further study needs to be done on how this data collected from a small segment of the farm relates to the whole farm's impact on the off-farm environment.

REFERENCES

- Dunne, T. and L. B. Leopold. 1978. *Water in Environmental Planning*. p. 818. W.H. Freeman and Company. New York, NY.
- Haith, D. A., R. Mandel, and R. S. Wu. 1992. *GWLF: Generalized Watershed Loading Functions - Version 2.0: User's Manual*: pp. 63. Department of Agricultural and Biological Engineering, Cornell University, Ithaca, NY.
- Pierce, F.J., R.H. Dowdy, W.E. Larson, and W.A.P. Graham. 1984. Soil productivity in the Corn Belt: An assessment of erosion's long-term effects. *Journal of Soil and Water Conservation*. 39(2):131-136.
- Rossing, J. 1995. Personal communication. department of Agricultural and Biological Engineering. Cornell University, Ithaca, NY.
- Walling, D.E. 1988. Measuring sediment yield from river basins. *Soil Erosion Research Methods*. p. 39-73. R. Lal (ed.). Soil and Water Conservation Society, Ankeny, Iowa.

**Integrating Knowledge to Improve Dairy Farm
Sustainability - Part VII:**

Environmental Assessment of Farm A

K. J. White and P. E. Wright

ABSTRACT

Five farm assessment tools were evaluated on their ability to identify and rectify potential farm environmental problem areas. The Ontario Environmental Farm Plan (OEFPP) was chosen for further study on case study Farm A because it was comprehensive and easy to use. Subsequent potential problem areas on this farm as identified by the OEFPP are prioritized and possible solutions suggested.

INTRODUCTION

The objective of this part of the project was to identify and evaluate farm environmental assessment tools. These tools were selected on their ability to identify and rectify potential farm environmental problem areas. Five farm assessment tools were considered. The Ontario Environmental Farm Plan (OEFPP) was chosen because it was comprehensive and easy to use. An OEFPP analysis was then done for case study Farm A. Subsequent problem areas identified by the OEFPP are prioritized and possible solutions suggested.

PROCEDURES

Choosing the farm assessment tool

The choices for the farm assessment tool included the following:

Ontario Environmental Farm Plan (OEFPP)

This plan has worksheets that cover a wide range of topics involving the farmstead and the fields. It has an analysis section that utilizes the information obtained in the worksheets. The Ontario plan is easy for the farmer to compile the data and complete the analysis without a technical assistance.

Farm*A*Syst (University of Wisconsin)

Farm*A*Syst focuses only on the farmstead instead of reviewing the farm overall. Although this plan has a limited range, each topic does have an information worksheet provided with it. This worksheet describes useful terms and alternatives to the solution of the problem. Farm*A*Syst is currently being expanded to cover more subjects.

Agricultural Pollution Prevention Program (Erie County, NY)

The Erie County plan gathers the data only. The plan is not user-friendly and the farmer must obtain outside engineering help in order to analyze the data.

Pequea-Mill Creek Information Series (Penn State)

This plan was extremely brief and only covered the barnyard related issues. The Penn State plan would not be as helpful in trying to complete an entire environmental assessment of the farm.

Environmental Planning for the Dairy Farm (Cornell University)

At the time the Cornell University plan was examined in March of 1995, the plan was extremely brief and did not cover as many issues. In addition, this plan did not have a section devoted to prioritizing the potential concern identified by the worksheets.

After examining the 5 tools, the decision was made to use the Ontario Environmental Farm Plan. At the time, the Ontario plan was the most comprehensive plan of the question/analysis format.

Overview of the Ontario Environmental Farm Plan

In the first section, *Reviewing Your Farm*, the OEFPP covers 23 various topics that are divided into three sections: the overall site, farmstead, and fields (Figure 1).

Figure 1. Ontario environmental farm plan worksheets

Overall Site

Worksheet 1- Soil and Site Evaluation

Farmstead

Worksheet 2- Water Wells

Worksheet 3- Pesticide Storage and Handling

Worksheet 4- Fertilizer Storage and Handling

Worksheet 5- Storage of Petroleum Products

Worksheet 6- Disposal of Farm Wastes

Worksheet 7- Treatment of Household Wastewater

Worksheet 8- Storage of Agricultural Waste

Worksheet 9- Livestock Yards

Worksheet 10- Silage Storage

Worksheet 11- Milking Centre Washwater

Worksheet 12- Noise and Odour

Worksheet 13- Water Efficiency

Field

Worksheet 14- Energy Efficiency

Worksheet 15- Soil Management

Worksheet 16- Nutrient Management in Growing Crops

Worksheet 17- Manure Use and Management

Worksheet 18- Horticulture Production

Worksheet 19- Field Crop Management

Worksheet 20- Pest Control

Worksheet 21- Stream, Ditch, and Floodplain Management

Worksheet 22- Wetlands and Wildlife Ponds

Worksheet 23- Woodlands and Wildlife

The plan can be used to evaluate several farms on the same sheet if the farmer owns farms in addition to the home farm. In addition, the other four farm environmental plans are oversimplified and would only be helpful if a quick assessment was desired. They do not contain enough information to obtain an accurate comprehensive environmental evaluation of the farm. As an example, not every farm will have a petroleum storage area, in which case that section would be eliminated. If one of the other plans were being used, one section out of the ten offered would be eliminated. In the Ontario plan, however, there would still be 22 areas to examine if one section were to be eliminated.

The plan is designed so that it can be completed by the farmer without requiring too much time or help from other individuals. In addition, the worksheets are designed so that they can be put aside at any given time when the farmer's attention is required elsewhere. Later, the farmer can pick up the plan where he left off, without any confusion at all.

Each worksheet is divided into categories of questions. The answer to the questions are rated on a scale of 1 (poor) to 4 (best). Choosing among the given set of criteria will help the farmer determine the rating that applies to his farm for each question. An example question is shown in Figure 2.

Figure 2. Example worksheet question

Worksheet #10 Silage Storage: How do you rate?									
Rating	Best	4	Good	3	Fair	2	Poor	1	
CONDITION OF SILO (Tower or Horizontal)									
3 Floors, walls and foundation	No cracks.	Some cracks.	Some cracks and stains.	Cracks and holes.	Your Rating	<input type="checkbox"/>			

After rating each question, the farmer proceeds to the analysis section entitled the *Action Plan*. The first step in the analysis is to account for all of the ratings with a 1 or 2. After writing a brief description of the problem, the farmer must determine the "barrier to action". The "barrier to action" is described as the reason why the farmer has not, or will not, fix a problem that has been determined to exist on the farm (Figure 3). After determining the barriers, the farmer must then select the timetable for action, ranging from already being done to no action. The complete "Action Plan" is displayed in Figure 4.

Figure 3. Barriers to action

1. Legislation or bylaws prevent using the best solution.
2. Expertise or information is not available.
3. Materials or services are not available.
4. No proven solution to the problem. Further research is needed to find a solution.
5. Solution is not realistic.
6. The cost is too high.
7. Lack of finances.
8. Personally, not an immediate priority.
9. No barriers to action.
10. Other

Figure 4. OEFP action plan

<h2>Action Plan</h2>					
Worksheet Question	Rating	Area of Concern	Action/Compensating Factor	Barriers to Action	Timetable for Action
					Already Being Done
	1 2			_____ 1st 2nd	<input type="checkbox"/> <input type="checkbox"/> <input type="checkbox"/> <input type="checkbox"/> <input type="checkbox"/>

RESULTS

Determination of problems

The Ontario Environmental Farm Plan was applied to Farm A in March 1995. The answers recorded on the worksheets were evaluated using the method described in the environmental plan. Each worksheet was examined for a rating of 2 (fair) or 1 (poor) (Figure 5). These ratings require a plan of action to be developed in order to meet the environmental regulations. The results of the high priority problems found on the case study farm are highlighted in bold print in Figure 5 and described in the following sections.

Figure 5. Problems discovered by use of action plan [rating: 4 (best), 3 (good), 2 (fair), 1 (poor)]

Worksheet	Pg.	Rating	Description
2	21	2	Position of water well in relation to potential source of contamination (surface water runoff may reach well)
2	22	1	Casing depth for the water well (less than 50 ft)
2	22	1	Age of the water well (more than 60 years old)
2	22	1	Type of water well (dug)
2	23	1	No backflow prevention on water well
3	28	1	Pesticide storage has floor drain that leads to tile drain, surface water source, etc.
3	29	1	Pesticide storage safety (no locked door, no warning sign at entrance, not ventilated to outside, no protective clothing equipment, no emergency numbers posted)
3	30	1	No backflow prevention on water supply
3	30	1	Regular mixing area of pesticides has no containment to prevent soil contamination
3	30	1	No filling supervision
3	31	1	Improper disposal of unrinsed containers on farm
3	31	2	Above ground tank- no emergency plan prepared in the event of a spill
5	48	2	Above ground petroleum tank is seldom locked
5	49	1	No dikes to protect against spills
5	49	1	Above ground petroleum storage tank is located less than 10 ft. from a building
5	52	1	Unused petroleum underground tank and piping not removed
5	52	1	Underground petroleum storage tank is located less than 3 ft. from a building
5	54	1	Underground tank- no emergency plan prepared in the event of a spill
6	61	1	Building components (concrete, stone, etc.) are buried, burned, or left in a pile on the farm
6	61	1	Restricted use old bldg. comp.(insulation, treated lumber, etc.) buried, burned, left in pile
6	63	2	Potentially hazardous materials on site are not fenced to prevent entry
8	82	2	Reducing wastewater/manure storage- excess washwater used, drainage enters barn gutters
8	83	1	Period of manure storage less than 90 days, application during wet/frozen periods unavoided
9	88	1	Yard design- upslope water from surface and roof water runs through the yard.
9	88	1	Yard runoff not collected or controlled, rarely scraped
9	88	1	Yard has no vegetative cover, feeding area not moved
10.	93	1	Silage storage is located less than 100 ft from nearest surface water source
10	94	1	No tight fitting cover on silage storage and many leaks are not repaired
10	94	2	Silage over 40 ft. deep is around 66-70% moisture
10	94	2	Silage seepage drained to field drainage system
11	99	1	More than 2 gal/day of milk often gets into milking center washwater
11	99	1	Manure, excess feed, and other solids often washed down drain in milkhouse
11	100	1-2	Milk center washwater storage, stone pit/wastewater lagoon
12	108	2	Manure not incorporated within 24 hours when spread within 1000 ft. of a residence
12	108	2	Liquid manure- irrigated
12	108	2	Solid manure- not incorp.when spread w/in 600 ft. of a residence, spread more than 2x yearly
12	108	2	Time of application- spread year round
12	109	1-2	Noise & Odor- natural ventilation in barns
12	109	2	Location- recreation areas near farm boundaries
12	109	2	Noise- more than 3 residences nearby (drying, filling, silos...)
15	132	2	Amount of organic matter in the soil- for loam soils 1-4%
16	139	2	Application of fertilizer- less than half is incorporated, due to manure
17	148	2	Poor soil conditions when manure is applied (wet or frozen soil, high risk of compaction field slopes toward well or tile drain, no tillage before liquid manure is applied)
17	150	1	Manure is not incorporated within 24 hours
17	150	1	Tile drains are not monitored
19	163	1	Equip. leaves less than 20% residue cover after planting, crop residue and chaff not spread
20	170	2	Pest control- fair because only two-crop rotation used
21	177	2	Streams and ditches- no buffer strips
21	179	2	Streams and ditches- no structure available for animals to cross stream

Water well

The water well on the farm is located in front of the heifer barn, as shown in Figure 6. The well could pose an environmental concern because is located too close to potential sources of contamination where surface runoff may reach the well. In addition, the well is considered to be poor according to the OEFPP rating system, since the well is dug, the casing depth is less than 50 ft., and the well is older than 60 years.

The well was not determined to be a high priority problem. Since the well only supplies one sixth of the water supply for the farm, the well is not considered to be a significant concern. This well may present a problem in the future. Groundwater is a complex networking of aquifers and aquicludes. Since it is highly probable that the well is linked to the rest of the groundwater, if the well were contaminated, it could affect the water supply for the farm. The groundwater that the cows drink from while in the barnyard could be affected. Therefore, the well should be monitored to prevent possible contamination when the groundwater recharges into the local streams.

Pesticide storage

The pesticide storage is a concern because the storage shed contains a floor drain that leads to a tile drain, surface water sources, etc. In addition, the storage facility is not properly labeled to meet the required environmental safety standards.

The problem with the pesticide storage could be solved with a few simple adjustments. The door to the storage area should be labeled with a pesticide warning sign and set of emergency numbers. The facility should also be ventilated to the outside, to insure the safety of the workers handling the pesticide. Although sometimes it may be impractical, the pesticide storage facility should be locked at all times. The most important procedure is to plug up the floor drain to prevent pesticide from contaminating the nearby surface water sources. Just as the water well could contaminate the local groundwater supply, the floor drain leading to the subsurface tile could pose a serious threat. If the pesticides were to be spilled down the floor drain, the local groundwater supply could be contaminated.

Petroleum storage

The underground petroleum storage tank on the farm is not being used. However, the tank and the piping still remain in the ground. Although the tank is not in use, residual fuel still remains in the tank. The tank can rust and leak petroleum into the local groundwater supply. The solution to this problem is to have the tank removed. This is the type of problem that the Department of Environmental Conservation considers to be a serious environmental hazard. Therefore, it is suggested that the tank should be removed even though it is relatively expensive. In the long run it would actually be cheaper to pay the expense of the tank removal rather than the fine and cleanup costs that could be applied by the Department of Environmental Conservation if a leak did occur.

Silage storage

The silage storage is located less than 100 ft. from the nearest surface water source. The silage seepage drains to the field drainage system. In addition, the silage has 66-70% moisture, which increases the leachate rate. The leachate from the bunk silo is traveling through the subsurface tiles, as shown in the diagram of the farm in Figure 6, and ending up in the creek next to the road. The rain water from the field behind the bunk flows into the same path as the leachate.

There are two main alternatives to solve the silage seepage problem, collecting only the low flow or all of the flow. The Coastal Zone Management Reauthorization Act of 1990 would require farmers to collect all of the leachate and runoff from the bunk silos located on their farms. However, this Act has to be adopted by each individual state, and New York State has not accepted this proposal at the present time. If New York does accept this Act as it exists, the Department of Environmental Conservation would start informing farmers that they must collect all of the run-off and leachate from the silos. However, catching all of the flow is very difficult and would be very expensive. Therefore, the option to be evaluated in this report is the low flow collection system.

The first step in preventing leachate is to harvest the crop at optimum moisture levels. The next step is to close all the walls of the bunk, especially the southeast corner. A set of 3'x3'x4' blocks can be placed in the corner to accomplish this task. To further improve the walls, a tar-based seal can be pressed between the T- panels. Next, the plastic covering over the silage should be left on until the time of feeding. This will prevent additional precipitation from entering the feed and producing more leachate.

Inevitably, effluent from the silage will be produced. Although the effluent can start when the bunk is loaded, peak flow usually occurs 5 to 10 days after the bunk is filled. Since the bunk is kept fairly clean, the run-off from rain should also be fairly clean after the first flush. Therefore, the focus should be on collecting and containing low flow effluent. The seepage around the walls can be collected in two manners. The first way is to dig a ditch 2' deep around the base of the walls. See Figure 7. The ditches should be graded in such a way that they converge at a point on the west side, where they are drained into the low flow collection system. The advantage of an open ditch is the particles of silage that fall over the wall, are contained by the ditch. However, the open ditch would create a problem with covering the bunk silos. During the year, as the silage is fed, the tires holding down the plastic are removed and stored around the outer walls. This continual crossing of the ditch by a loader's front tires, would block the ditch or allow leachate to escape over the banks, especially when the soil is saturated with water. Under wet conditions, the second alternative of a buried tile line may prove to be a more feasible alternative for collecting leachate. See Figure 8. This system also has a major drawback in the inability to capture the particles of silage.

Figure 6. Sketch of Farm A layout (not to scale)

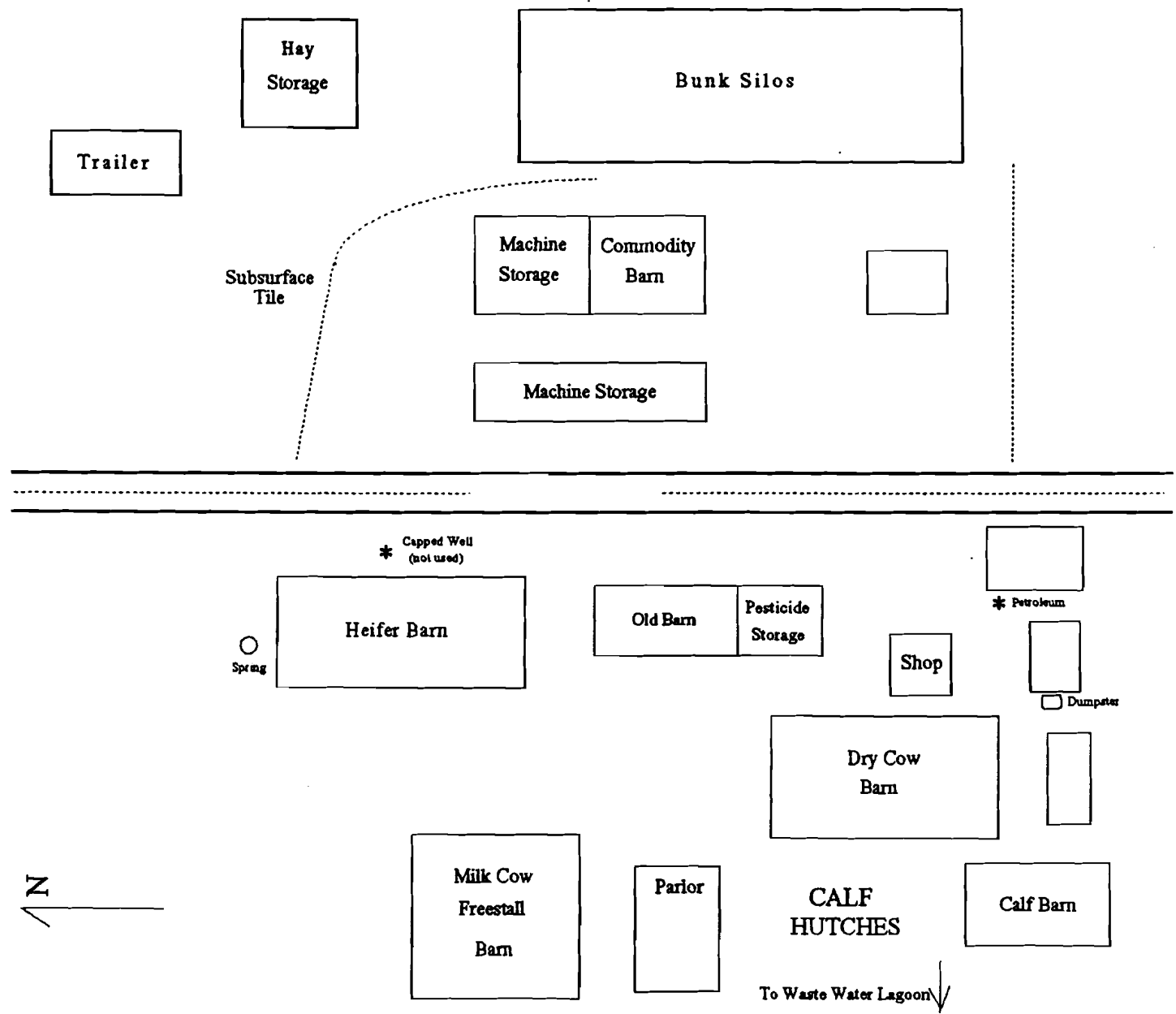

Figure 7. Side view: open ditch silage leachate and run-off collection option

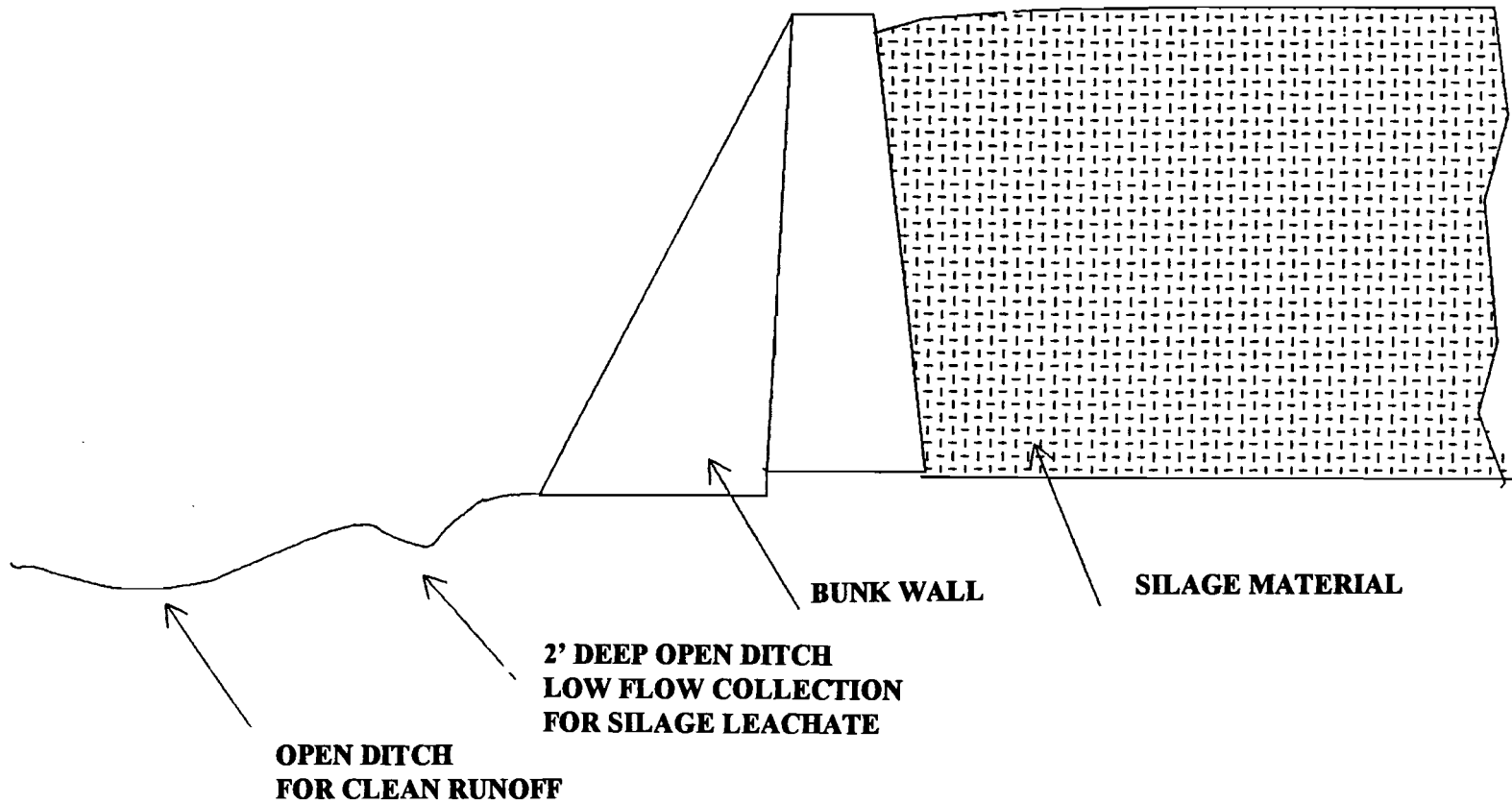
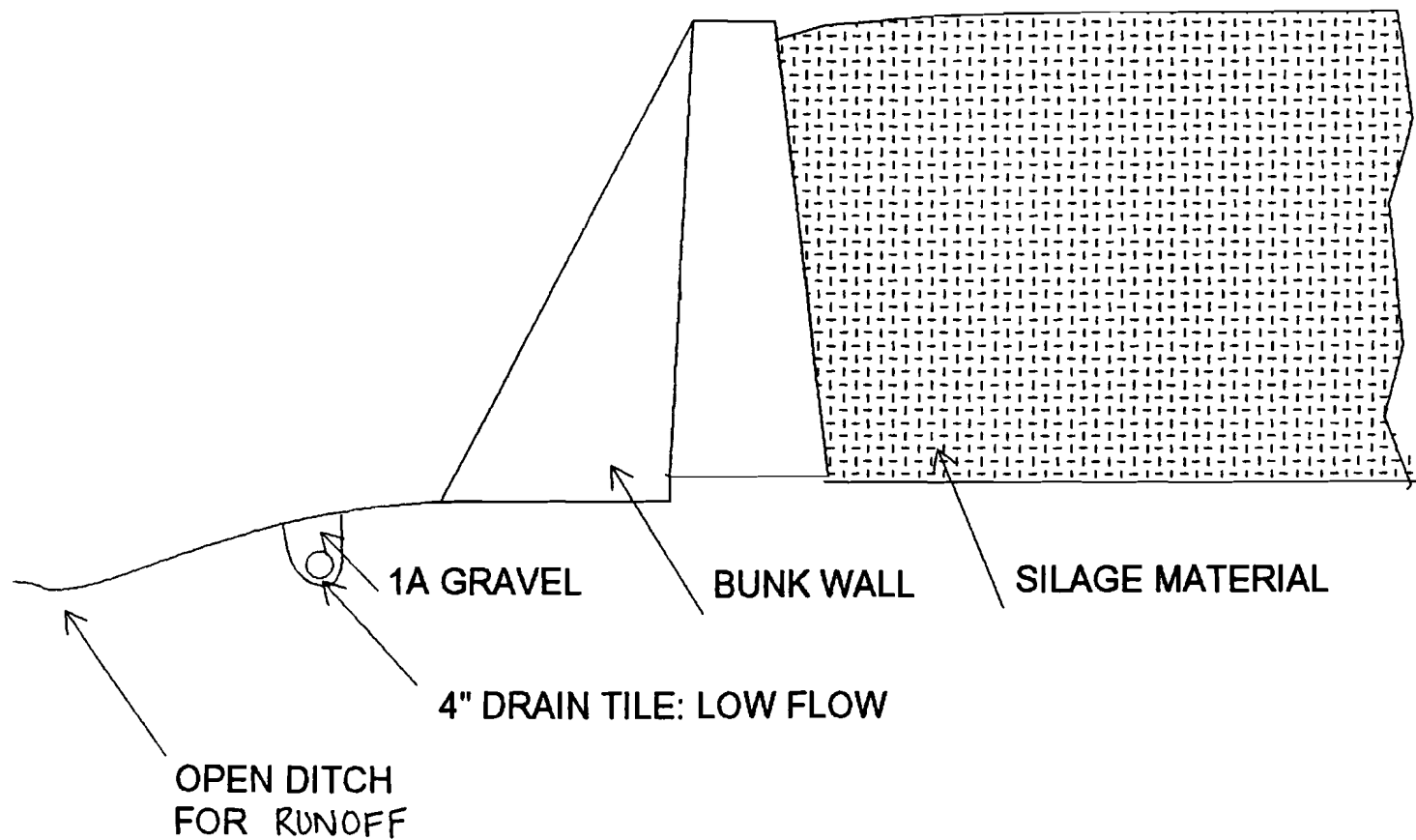
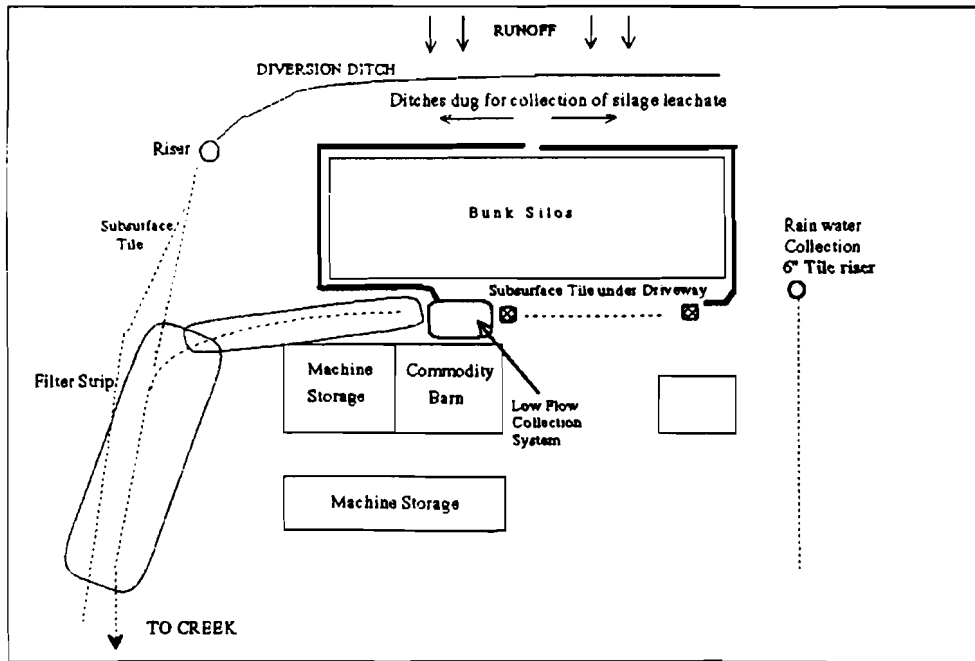

Figure 8 Side view: drain tile leachate and run-off collection option



A survey of the area around the bunk showed that either the open ditch or the buried tile line could be installed fairly easily with minimal grading. A grassed waterway would need to be implemented in order to catch and filter diluted high flow effluent. A 200' filter strip could be placed northwest of the bunk. The surface water run-off from the fields east of the bunks should be diverted to a riser located by the northeast corner of the bunk. This riser is connected to a 6" tile line which will join the subsurface tile running from the northwest corner of the barn to the road (Figure 9). The tile path should be along the filter strip. The filter strip will be approximately 200 ft long and 20 feet wide. It will be seeded to Tall Fescue.

Figure 9. Overview of bunk silos



With either option, the effluent must be directed to a low flow collection system. See Figure 10. The low flow effluent flows through the subsurface tile line to the side of a buried 2000 gallon septic tank. When the septic tank becomes full, it is pumped out into the tank spreader. The collected leachate can then be spread on the fields along with the manure or dumped into the manure pond.

The ditch must be kept in good condition in order to insure that the effluent is collected properly. The grass around the low flow ditch must be maintained to prevent the ditch from becoming plugged and overflowing. In addition, the filter strip must be mowed at least twice a year to maintain a proper stand.

Figure 10. Low flow collection system (not to scale)

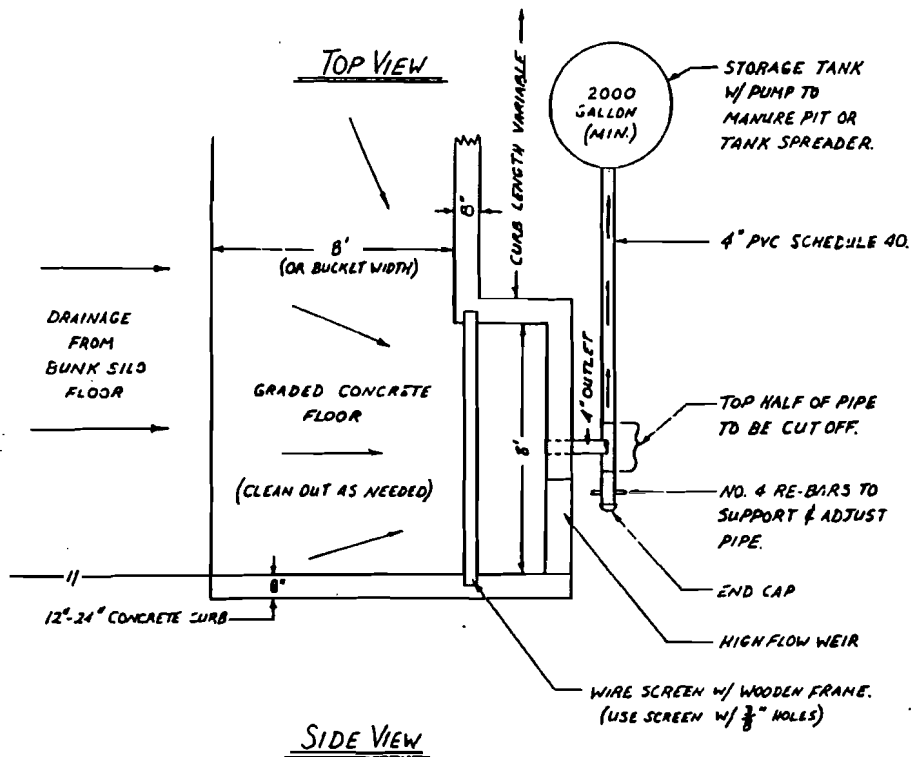

END VIEW (FRONT)

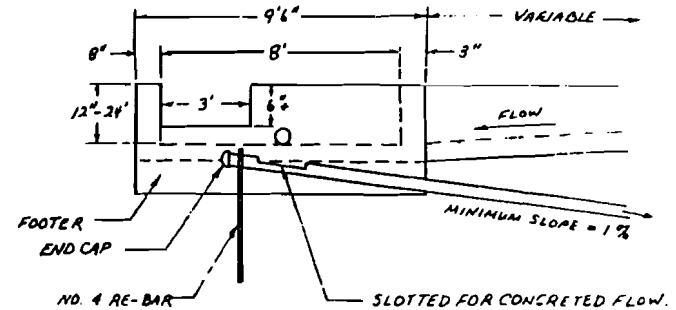

NOTES

- 1- FILTER AREA SHALL BE GRADED 1% MINIMUM.
- 2- ADJUST PIPE TO COLLECT CONCENTRATED FLOW ONLY AND TO PREVENT KILL ZONE IN THE FILTER AREA. THIS WILL KEEP STORAGE TO A MINIMUM.
- 3- FILTER AREA TO BE SEEDED TO: TALL FESCUE OR ANY OTHER DENSE, SOD FORMING MIXTURE.
- 4- SOME DIMENSIONS MAY BE CHANGED TO ACCOMMODATE VARIABLE FIELD SITUATION. THIS CAN BE USED AS A GUIDE.

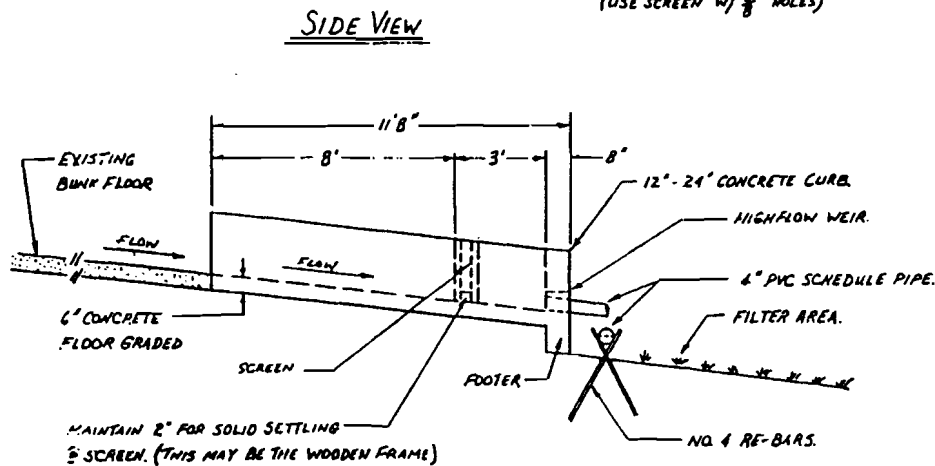

BUNK SILO EFFLUENT CONTROL
LOW FLOW SILAGE PUNDEF COLLECTION
SYSTEM

PW & DL 6-74
GM 6-74

Manure storage

The manure storage rates as a priority problem in the environmental farm plan because the manure is spread year round. Presently, Farm A has only a ten day manure storage under the milk cow freestall barn. This storage facility is well under the suggested 90 day storage. Therefore, the farm is forced to spread manure almost on a daily basis. The fields are often damaged because they must spread even under poor soil conditions: saturated soil after heavy precipitation, frozen soil during the winter, etc. Spreading under these conditions can cause increased surface runoff, soil compaction and ruts to form in the fields.

The manure is not incorporated within 24 hours after it is spread within 1000 feet of a residence, increasing the possibility of odor problems. In addition, although it is not covered in this report, the manure also loses its ammonia nitrogen when not incorporated within a short period of time.

There are several alternatives for solving the manure storage problem. A few of these solutions are listed below:

1. Remote manure pond, truck only. With this solution, the manure is dumped into a satellite manure pond by a tank spreader when the storage at the main farm becomes too full. This option causes an increase in labor since the manure must be hauled twice; once to the manure pond and once to the field.
2. Remote manure pond, Pumped, No separator. In this system, when the main cow barn capacity is full, a motor pumps the manure underground to the satellite manure pond. This may be a better solution since it cuts down on labor costs. However, it would be difficult for Farm A to gain land rights to lay the pipe connecting the main barn with a manure pond.
3. Storage on main farm with draghose application. In this situation, the manure pond would be located on the main farm. Twice a year, the manure pond would be emptied by the use of a draghose. The draghose system incorporates the manure as it is applied. Reducing the number of times during the year that the manure is spread and incorporating manure immediately will assist in odor control. However, using a draghose increases equipment costs and limits the use to the main farm only.
4. Methane generation, store on main farm. Methane is a byproduct of manure digestion. Methane energy can be used to produce electricity. This system has a large maintenance requirement, but is the most effective in odor control. A 30 day retention is required for the methane gas to be produced. This system has not been accepted by farmers due to reliability and cost concerns.

A satellite manure storage pond can be built at a remote location as shown in Figure 11. The first step in building the pond is to dig test pits to insure that the soil is suitable. If the ground contains springs, the pond could fill up with spring water, reducing the storage volume for the manure. The water table must be located to insure that the water is below the lowest level of the pond. Unless the soil has a high concentration of clay, either clay fill or a plastic liner must be used to prevent the manure from leaching into the groundwater. This pond will be located at least 200 feet from the road to reduce public apprehension.

Figure 11. Farm A home farm and remote farm crop fields (not to scale)

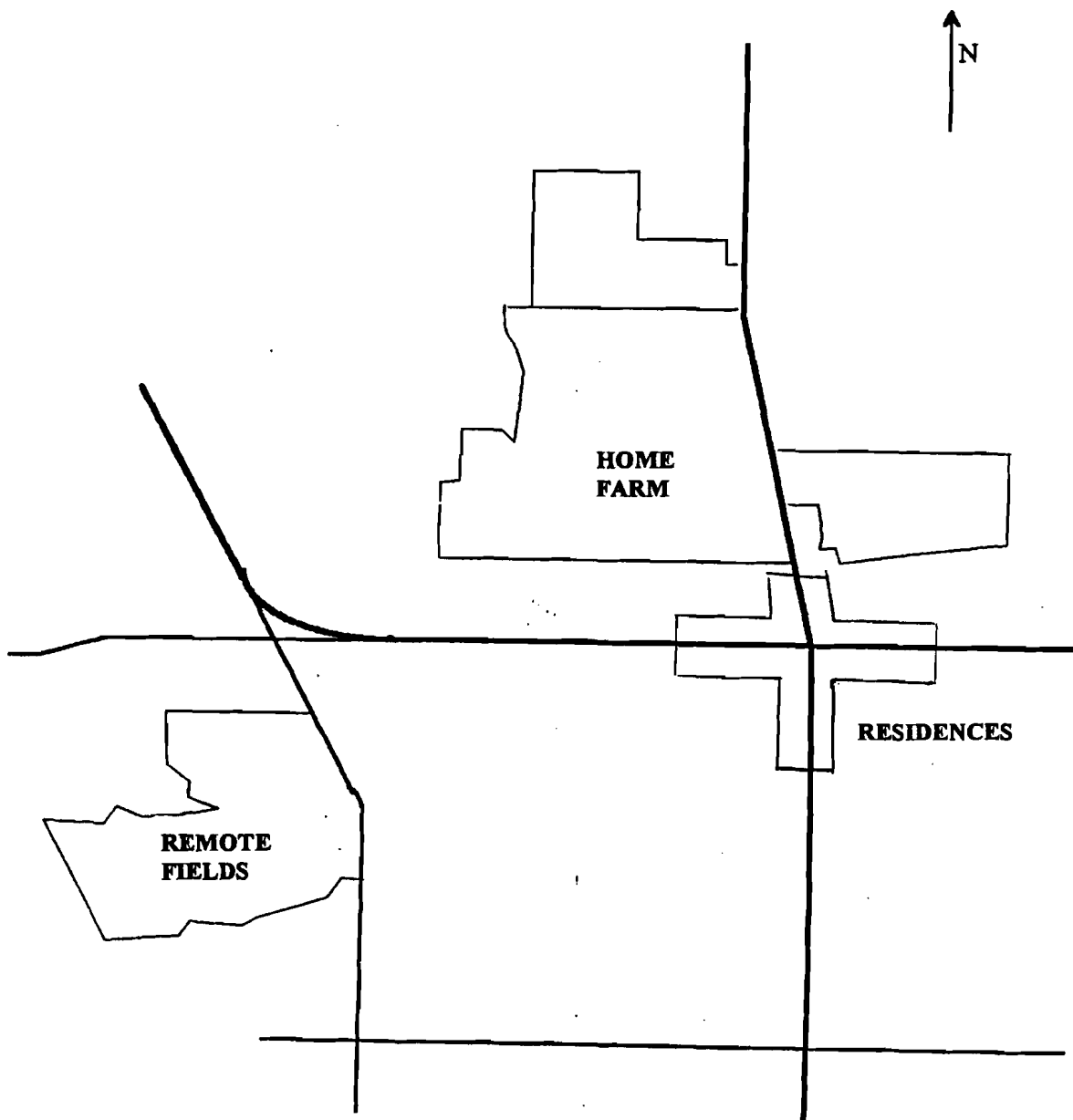

The minimum storage requirement for the satellite manure pond was determined using the data from Farm A's Nutrient Management Plan (see Part II, Klausner et al.). Using this data, it was determined that the fields of alfalfa and corn at the remote site needed the nutrients contained in 906,000 gallons of manure. At the present time, there are three fields at the remote site that are not receiving manure. It is estimated that within two years, these fields will receive 12,000 gallons of manure per acre. This additional amount of manure for the approximate 18 acres is 216,000 gallons. This allows a minimum requirement of 1,122,000 gallons of storage to meet the nutrient management needs of the land at this location.

When designing the manure pond, additional volume must be taken into account for precipitation, freeboard, and sedimentation. This amount is estimated to be around 30% of the minimum storage volume. This extra amount of 336,600 gallons is added to the minimum volume to produce a new volume required of 1,458,600 gallons. With the installation of the milk center wash water recycling system, additional water will be mixed in with the manure. Assuming a minimum of 700 gallons per day of wash water, the total water resulting from the recycling system is 255,500 gallons. The final total for the volume of the manure pond is 1,710,000 gallons. The design capacity of 1,710,000 gallons is overestimated. To cut down on labor costs, the farmer will probably end up spreading directly to the fields when the conditions are appropriate. The manure will not be dumped into the storage pond everyday. The dimensions of the manure pit will be 100 ft. wide (average width) by 200 ft. long by 14 ft. deep (Figure 12). The economic impact of installing a remote manure pond, without adding milk center wash water is considered in Part IV of this report (Rasmussen et al.).

The manure pond requires very little maintenance once the pit is dug. The pit must be agitated before the manure is spread. This process breaks up the solids that form at the top of the pond and gives a homogenous manure mixture so that the nutrient values are consistent.

Milk center washwater

The washwater from the milking center is being pumped out to an aerobic pond located approximately 1000 ft. west of the parlor. The pond is being overloaded. It was designed for a smaller amount of waste. In addition, there is a significant amount of solids that get washed down the milk center floor drain. The volume of the storage is being depleted due to the accumulation of these particles in the storage. The pond was used to allow the particles enough time to settle out and to reduce the biological oxygen demand (BOD) in the waste before the water overflows into a pipe which leads to the creek. This wastewater lagoon was designed to remove unwanted particles and BOD that could contaminant the water before it leaves the farm. In addition, the producer would like to reuse the water from the milk center wash water to help wash the parlor.

Figure 12. Diagram of manure pond

One corner has smaller incine for manure pump to be driven in

DIMENSIONS:

100' x 200' x 14'

2:1 SIDE SLOPES

12' DRIVEWAY AROUND
POND

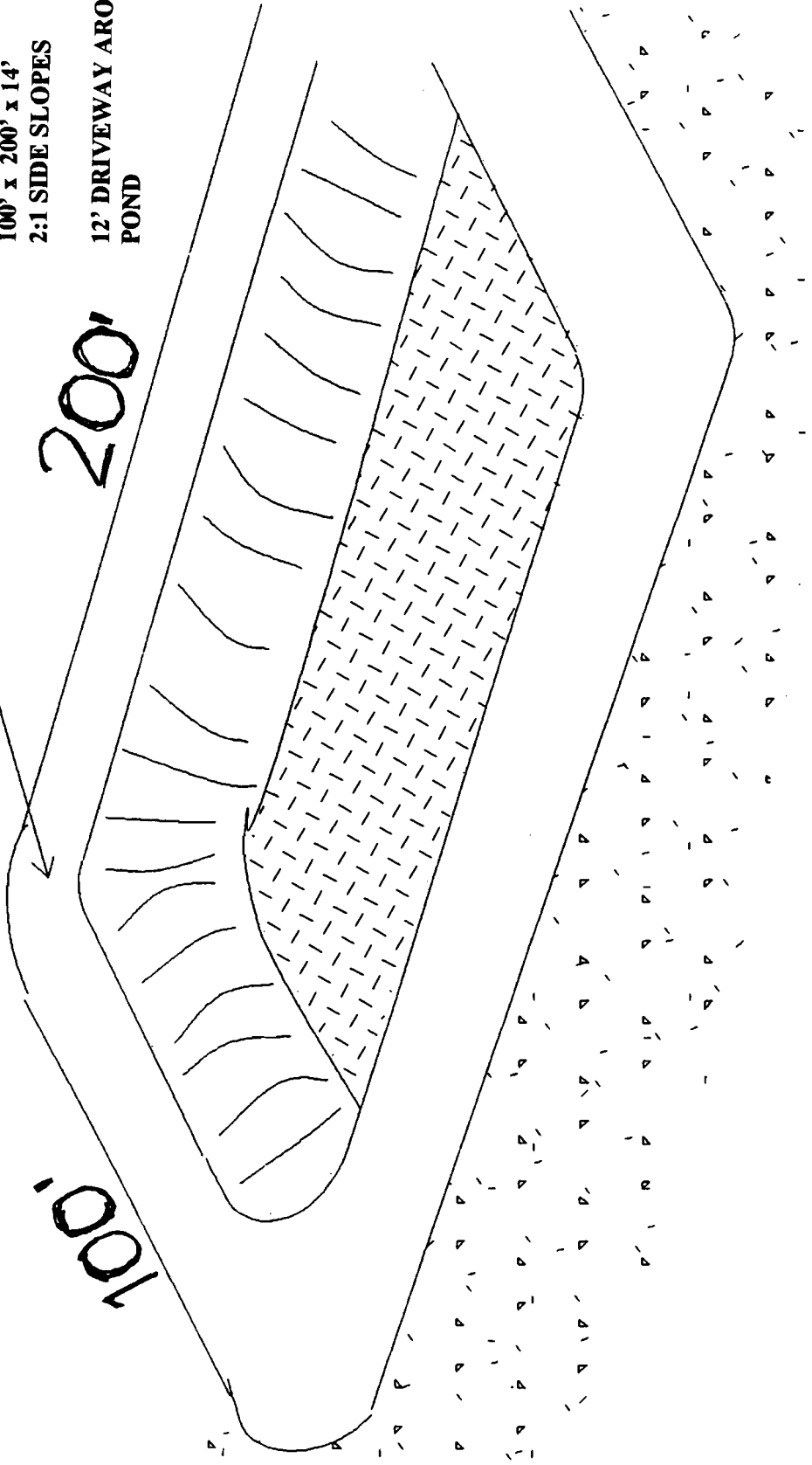

The best method to recycle and reuse the wash water is to collect the water from the washing process, store it in a tank, and use it to wash down the parlor. The cows are milked three times a day at the farm. It is estimated that each milker takes approximately twenty minutes to wash down the parlor after milking. By using a rough estimate of the time it takes to fill a 5 gallon bucket, 30 seconds, the approximate amount of water used per cycle was determined to be around 200 gallons. The farm must then have a facility to store at least 600 to 700 gallons of water a day in order to have the minimum amount of water to wash the parlor. The first cycle, or the rinse cycle, will not be collected in the storage tank. This water is full of milk-fat and is undesirable when washing down the parlor. Therefore, this water will continue to flow into the floor drain to be diverted to the waste water pond. Because of the recycling, the amount of water entering the pond will be reduced by approximately 70% and it will not fill up as fast. The second, third, and fourth cycle wash water will be sent to a second piping system by a device that automatically diverts the flow (Figure 13). This device is controlled by electro-pneumatics (Figure 14). It is connected to the washing control panel so it can determine which cycle the wash is in (Figure 15).

After being diverted to the alternate pipe, the water flows by gravity into a 1500 gallon septic tank. The size of the tank provides room for expansion capabilities. In addition, the tank will be able to store enough water in case a thorough cleaning is necessary at any given time. The tank will be located adjacent to the bulk tank, as shown in Figure 16.

The septic tank will be equipped with a 3 horse-power (hp) sewage pump. Using a sewage pump will allow the particles in the water to be pumped through the system, rather than accumulating on the bottom of the tank. Next, the water will be pumped to the parlor area with a hose flowing to either side of the parlor. The 3 hp pump will be hooked up to a switch to turn the pressurized system on and off (Figure 17). Using this system will help to reduce the amount of water that is used from the current municipal water supply. Reusing the wash water will also help to reduce the amount of water that is pumped to the wastewater pond.

The water system that is currently in the barn will remain intact. When a milker wants to do a quick rinse of a milking unit, it would be easier to use the hose that is hooked up to the main water supply since it does not require turning on the 3 hp pump. Furthermore, it is necessary to do an occasional thorough cleaning of the parlor. In this case, the fresh water from the water supply would be better to use.

The milk center wash water recycling system is low maintenance. However, an occasional inspection is required to insure that the tank is not leaking. Although a sewage pump is being used, there is slight possibility that solids may build up in the bottom of the tank and must be removed.

Barnyard runoff

The run-off from the barnyard flows into several drains located throughout the barnyard. These drains flow through subsurface tiles to the creek. This is dangerous because spilled pesticides or manure could have direct access to the stream, thus affecting local water supplies. This water should be diverted to the wastewater pond located adjacent to the main cow barn. Since 70 % of the water from the milk center wash water is being rerouted to the manure pit, only a small volume of the wastewater pond will still be used. Therefore, there is room to pipe the runoff from the barnyard into the wastewater pond. The subsurface tile from the barnyard drains will be rerouted to the existing drain flowing to the wastewater pond (Figure 18).

Figure 13. Flow divider apparatus

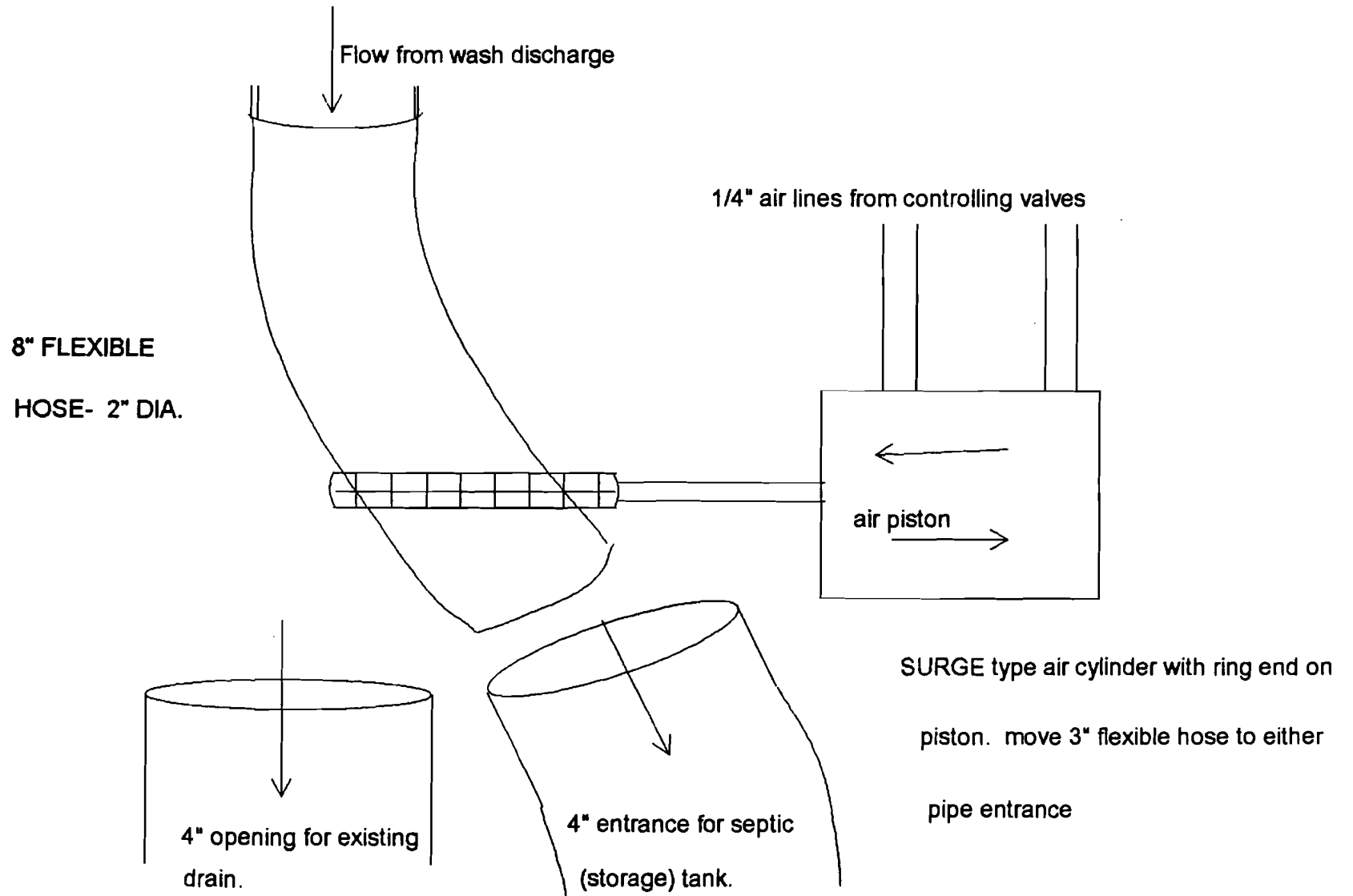

Figure 14. Pneumatic air controls for flow control

How a three-way valve works:

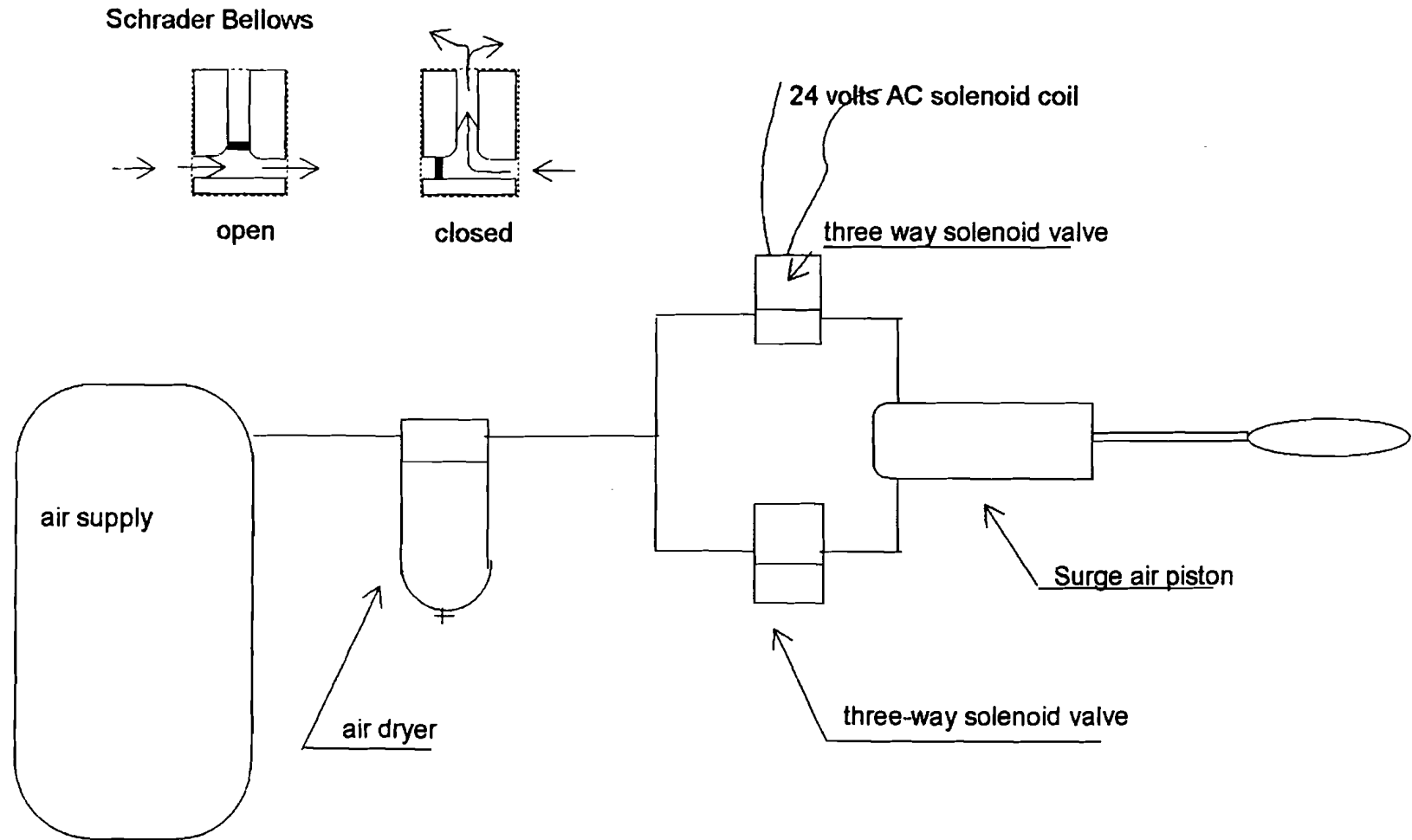

Figure 15. Milk center washwater control logic

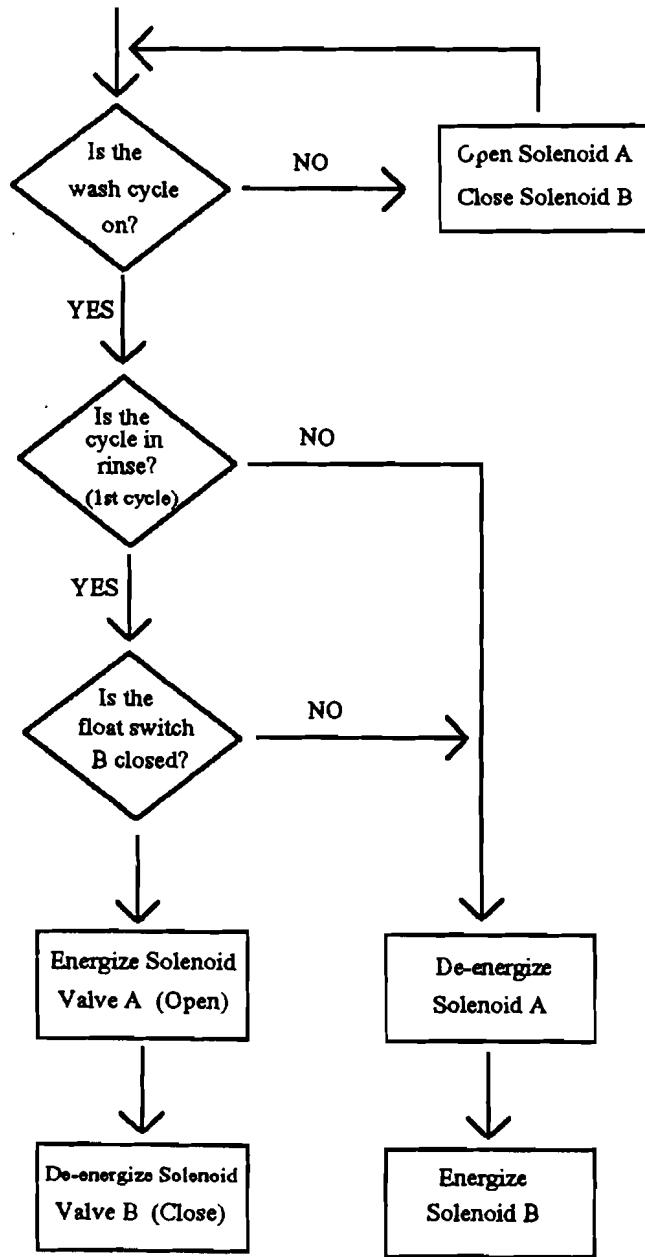

Figure 16. Location of septic tank for milk center wash water

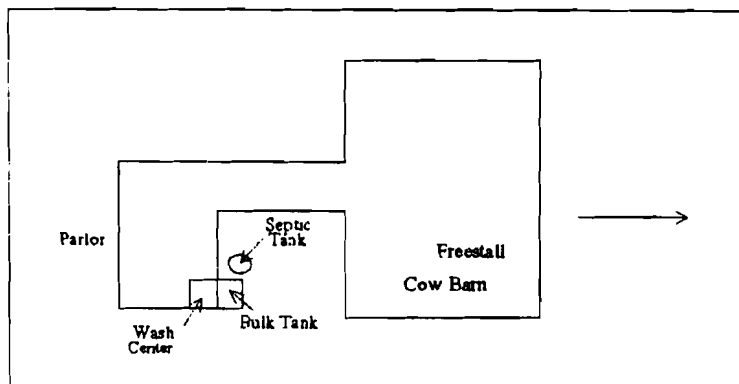

Figure 17. Wash water recycling system

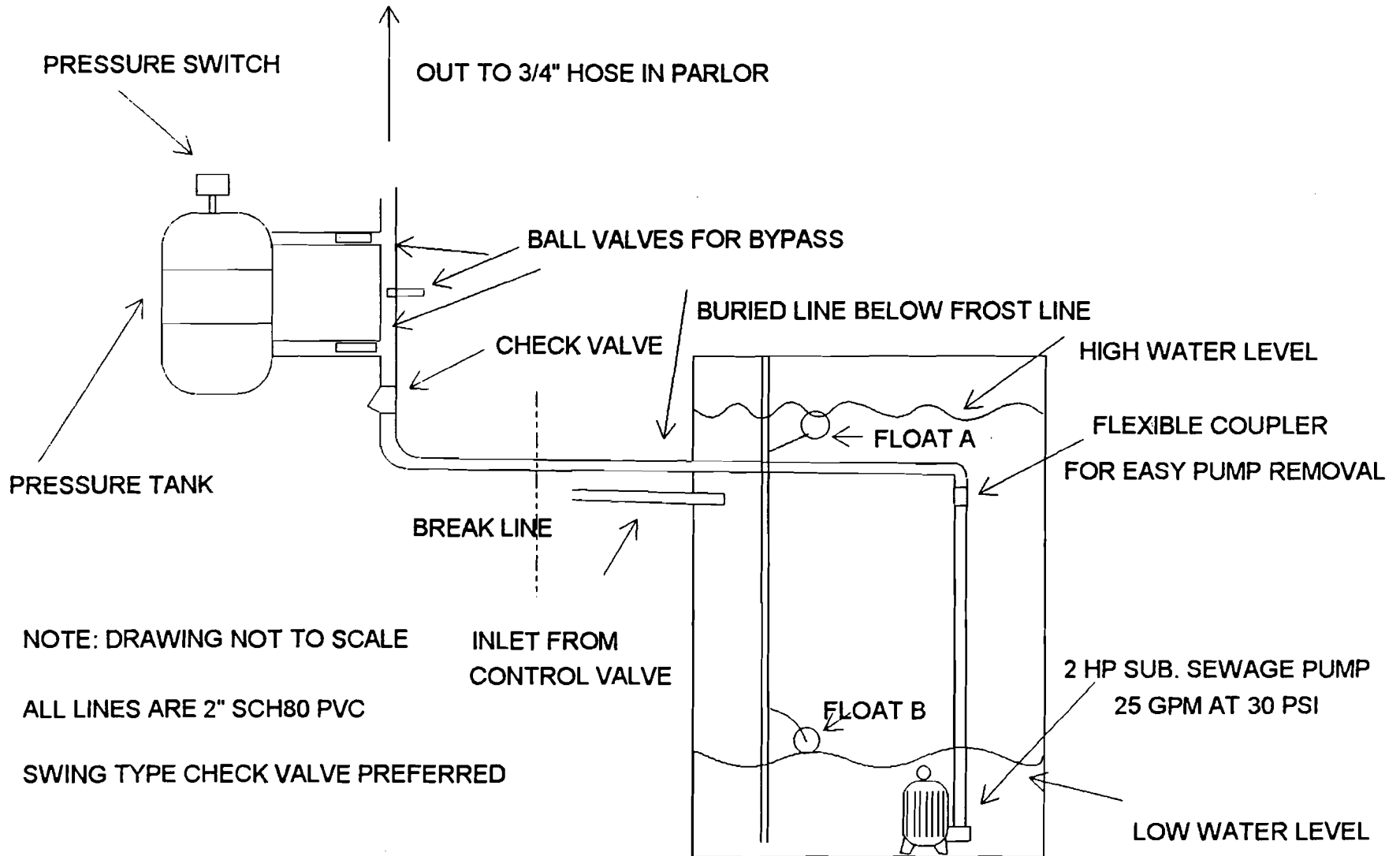
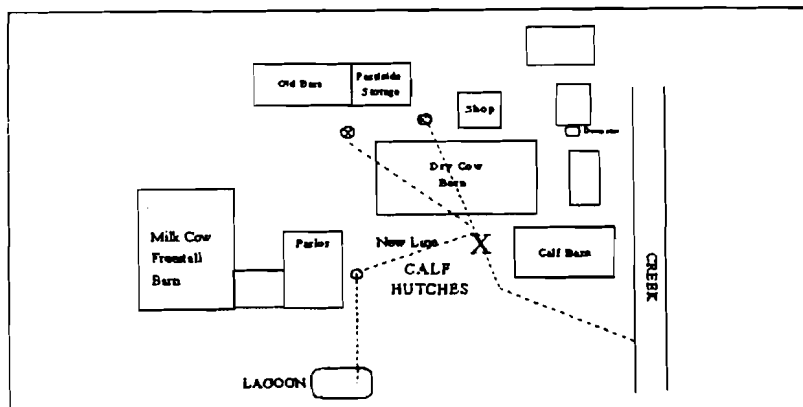

Figure 18. Barnyard Runoff



DISCUSSION

One of the main problems that occurred while using the OEFP was that many of the regulations applied to the Ontario legislation. To determine a rating on each question, the plan often states "meets the requirements of OMAF" (Ontario Ministry of Agriculture and Food). Without knowing the specific guidelines of the OMAF, it is impossible to answer all of the questions. If this plan were adopted to the guidelines of this area, it would be more productive. In addition, the worksheet that deals with soil erosion refers to the Ontario soil maps, which differ from the soil maps in this area. However, the plan was very easy to follow and simple to complete. I believe that with a few minor changes to adapt to the local regulations, the OEFP could be very helpful to the New York State farmers. Alternatively, the Agriculture Environmental Planning (AEP) could be expanded to include the other issues.

After completing the plan, I asked the participating farm manager to give his opinion of the OEFP. His first comment was that the plan was not as time consuming as he originally thought it would be. The plan was very easy to use and can be completed by the farmer alone which is a great feature. He felt that it was thorough and covered the main topics of concern on the farm. In addition, he stated that the plan helps a farmer to realize where he stands in the 'rating' of safety and environmental regulations. This plan helps give the farmer a realistic standard to go by. The dairy producer also liked the idea of the barriers to action. This section allows the farmer to state why the problem has not been fixed before, and to determine a time frame for it to be fixed. However, he suggested that an additional barrier should be 'not informed of problem'. Many farmers do not notice during their busy day some of the things that regulating agencies deem to be in violation of code.

It would be good to have a system that could help farmers determine and plan to fix potential environmental problems without being forced to by regulations. By planning ahead, solutions to potential environmental problems can be incorporated into facility improvement and expansion in a cost effective manner.

**Integrating Knowledge to Improve Dairy Farm
Sustainability - Part VIII:**

Pathogen Prevalence and Management

S.E. Wade

ABSTRACT

Since agricultural animals are potential sources of *Giardia* sp and *Cryptosporidium parvum* (C.parvum), accurate prevalence data are necessary. For calves less than six months old, 70% of the calves on Farms A and B were sampled. For animals six months old to first freshening, samples were collected from at least six animals. Older than first freshening, samples were collected from at least nine animals. Laboratory examination of the fecal samples collected was carried out using quantitative centrifugation flotation technique and the antigen capture enzyme linked immunosorbent assay (ELISA) test.

When animals of all ages were considered, *Giardia* sp. was present in the feces of 19% of the animals sampled on Farm A, and in the feces of 13% of the animals sampled on Farm B. When considering animals under six months of age and at most risk of becoming infected, 24% of the calves sampled on Farm A, and 17.5% of the calves sampled on Farm B were infected with *Giardia*. When animals of all ages were considered, *Cryptosporidium parvum* was present in the feces of 7% of the animals sampled on Farm A, and 6.5% of the animals sampled on Farm B. In animals under six months of age, 9.7% of the calves sampled on Farm A, and 8.8% of the calves sampled on Farm B were infected with C. parvum. Guidelines were developed for each farm to help reduce the prevalence and control the movement of these parasites.

INTRODUCTION

The Safe Drinking Water Act and its amendments, and the Surface Water Treatment Rule require EPA to regulate public water systems by instituting regulations which set maximum contaminant levels, or by having a water treatment technique which removes contaminants which may cause disease in humans. Turbidity of the water, coliform and other bacteria, viruses, and the parasitic protozoa *Giardia* sp. must all be regulated. At the present time, *Cryptosporidium parvum* is not covered by regulations. Because of these regulations and widely publicized outbreaks of intestinal disease in humans (cause not always determined), interest in the biology and prevalence of *Giardia* sp. and C. parvum has increased.

Cryptosporidium parvum from calves is known to cause infection in humans, so reducing the prevalence of this parasite is important for public health reasons. This parasite also adversely affects the health of calves causing severe diarrhea, and dehydration. This leads to slower growth and can ultimately affect the economic situation of the farm.

The potential for disease transmission from animals to humans of *Giardia* sp. is not clear at this time. The disease causing potential of *Giardia* in ruminants is also not clear, although it has been reported to cause diarrhea in calves.

MATERIALS AND METHODS

Since agricultural animals are potential sources of *Giardia* and C. parvum, accurate prevalence data are necessary. Both protozoa are found primarily in young animals. Based on the reported prevalence of these protozoa in cattle, and experience with a New York City Watershed design at 108 dairy farms, it was determined that on each farm sampled, it would be necessary to obtain the following:

- for calves less than six months old, if 20 or fewer calves present, all calves were sampled; if more than 20 present, 70% of the calves were sampled.
- for calves six months old to first freshening (about two years old), samples were collected from at least six animals.
- older than first freshening (milking and dry cows mainly) - samples were collected from at least nine animals.

Laboratory examination of the fecal samples collected was carried out using the following methods:

1. Quantitative centrifugation flotation technique. All fecal samples were prepared for microscopic examination using this technique. Sugar and zinc sulfate were used as the flotation media. For each parasite seen, the number of protozoa cysts/gram were determined.
2. Antigen capture enzyme linked immunosorbent assay (ELISA) test for *Cryptosporidium*, distributed by Alexon, Inc., CA.

This ELISA test was developed for human testing and is currently being validated for use with other species. Fecal samples were tested using this technique as part of this continuing validation.

RESULTS AND DISCUSSION

Pathogen Prevalence

On Farm A, fecal samples were collected on April 29, 1994, from 84 of the 599 dairy animals on the farm. Samples were processed using routine fecal flotation techniques. Fifteen of the 62 samples from animals less than six months were positive for *Giardia sp.*, and one of seven samples from animals greater than six months was positive for *Giardia sp.* All 15 milking animals examined were negative for *Giardia*.

On Farm A, *Cryptosporidium parvum* was recovered by flotation from two of 62 samples obtained from calves under six months of age. This is a parasite that is not recovered from dairy animals over three months of age. An antigen capture ELISA test for *Cryptosporidium* was run on 32 of these 62 samples. Six samples were positive, including the two that were flotation positive.

On Farm B, fecal samples were collected from 108 of the 998 dairy animals on May 13, 1994. *Giardia* was found in 14 of the 80 samples collected from animals less than six months of age. *Cryptosporidium parvum* was recovered by flotation in two of these 80 samples. Forty-five of the 80 samples were run on the *Cryptosporidium* ELISA test. Seven were positive, including the two positive by flotation.

On both farms, several species of the protozoa *Eimeria* were recovered from fecal samples in animals of all ages. The cysts of *Eimeria spp.* must incubate in the environment for several days before they are infective to another animal. Some heifers on both farms were excreting high enough numbers of cysts to cause clinical illness.

Calf Housing and Health Recommendations

Management is critical to control of *Giardia* and *C. parvum*. Suggested management changes on both farms include better and more frequent cleaning of the hutches and pens. *Giardia* cysts may be, and *C. parvum* oocysts are immediately infective, while those of *Eimeria* are not. In the case of *Eimeria*, prompt regular cleaning will remove cysts before they are infective and help to reduce infection. Cleaning includes removing fecal material and soiled bedding, and washing with pressure washers or similar equipment. At this time, no commonly used disinfectant effectively kills the cysts of *Giardia* and *Cryptosporidium* at levels recommended for use around animals. After cleaning the hutches, they must be allowed to dry (tipping upside down and exposing them to sunlight helps kill the cysts), and rotated to a new position.

The high numbers of *Eimeria* in the animals suggest that the management of the coccidiostat (Bovatec) being used needs to be checked. The dose may need to be adjusted, or the animals may not be eating enough of the medicated feed. This is not an issue related to water quality, but it does affect the health of the animals, the amount of feed needed by these animals, and ultimately the economic situation on the farm.

Farm A needs to provide more area for calf hutches to allow for more space for rotation of the hutches. The type of hutches used are able to be well cleaned, and the hog wire fencing around each hutch to prevent calf to calf contact are both good management practices.

At Farm B, the plywood hutches can not be cleaned or dried sufficiently to kill or remove all infective cysts. There is calf to calf contact, so if the animals do not become infected from the environment, they can become infected by contact with infected animals. Because there is not enough room where the hutches are currently placed to rotate their location between calves, the hutches need to be moved to an area of sufficient size. For water quality reasons, the hutches also need to be moved further from a water course.

CONCLUSIONS

The best recommendation we can offer at this time is to promote the best possible calf and heifer management possible. The following list of management practices to improve health of young stock needs to be incorporated into any good management program.

- Provide adequate colostrum and nutrition
- Reduce calf to calf contact
- Keep calves in warm and dry environment
- Raise preweaned calves separately
- Clean and disinfect hutches or pens between animals
- Handle healthy animals before sick animals
- Control rodents and pets to prevent fecal contamination of feed
- Use prophylactic measures such as coccidiostats and vaccines

REFERENCES

- Dubey, JP, CA Speer, R Fayer, eds. 1990. *Cryptosporidiosis of Man and Animals*. CRC Press, Boston.
- Erlandsen, SL and EA Meyer, eds. 1984. *Giardia and Giardiasis*. Plenum Press, New York, NY.
- Georgi, JR and ME Georgi. 1990. *Parasitology for Veterinarians*. 5th ed., WB Saunders, Co., Philadelphia, PA.
- Kirkpatrick, CE. *Giardiasis in Large Animals*. Compendium on Continuing Education for the Practicing Veterinarian, Article #7, 11(1):80-84.
- Levy, PS and S Lemeshow. 1980. *Sampling for Health Professionals*. Life-Time Learning Publications, Belmont, CA.
- Ungar, BL. 1990. Enzyme-linked immunoassay for detection of *Cryptosporidium* antigens in fecal specimens. *Journal of Clinical Microbiology* 28(11):2491-2495.

**Integrating Knowledge to Improve Dairy Farm
Sustainability - Part IX:**

**Dairy Farmers in Cayuga County, New York:
World View**

P.M. Crosscombe and D.M. Ewert

ABSTRACT

This study, based on interviews with 34 Cayuga County farmers, examined farmers' perceptions about the environment, change and the future. Main questions included (1) To what extent do farmers perceive an environmental crisis. (2) How do farmers view the future? (3) How do farmers decide to make management changes on their farms? One main fear of the future cited by farmers was the increasing influence that the non farm sector has in the development of farm regulation. Farmers in this study get their information from a variety of sources, especially farm oriented magazines, and other farmers. Most farmers adopting new management practices were motivated more by economic than environmental considerations. Many farmers feel that they are being left out of discussions regarding environmental issues and are being defined as causing environmental problems by people who do not understand the context. An understanding of how farmers view environmental issues, make management decisions, and feel about the environment will be helpful in the design of effective extension programs that protect the sustainability of dairy farming in New York State.

INTRODUCTION

The changing face of rural communities is transforming the nature of dairy farming in New York State. Increasing pressure to protect the environment is spawning new regulations that restrict certain practices. How do farmers feel about this and how do they make management decisions about environmental issues? That question frames this study.

Methodology

In March and April 1995, we conducted individual, 45 - 60 minute interviews with 34 farmers on 29 farms in Cayuga County. With the assistance of Cornell Cooperative Extension agents, we selected a cross-section of farms by size, location, and participant gender and age. We tape recorded and later transcribed the interviews. Figures one and two, show the breakdown of the participants in this study by their age and herd size.

Figure 1. Herd size of study participants

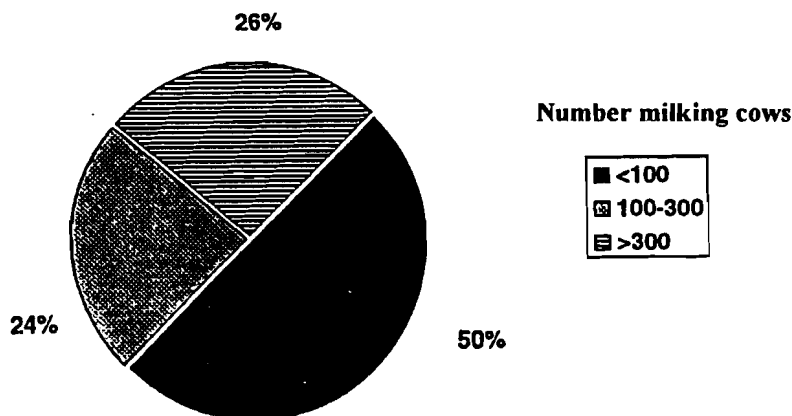
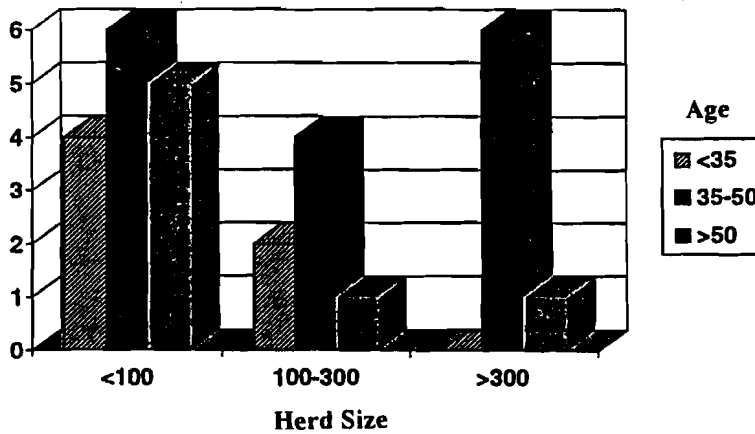

Figure 2. Age of farmer and herd size



PRELIMINARY FINDINGS

The Process of Changes: Phases

In looking at how farmers made management decisions, we found that change follows a process of integrating context, knowledge gathering, assessment, experimentation and implementation of new management practices (Figure 3). Context sets the stage for change. How farmers view the future of farming, perceive fears of the future and consider the environment contributes to the kinds of changes considered. Next, the farmer gathers knowledge and makes an assessment of the information collected. Finally, experimentation occurs and leads to the implementation of new management practices. For most farmers, this process of change repeats itself.

Figure 3. Process of change

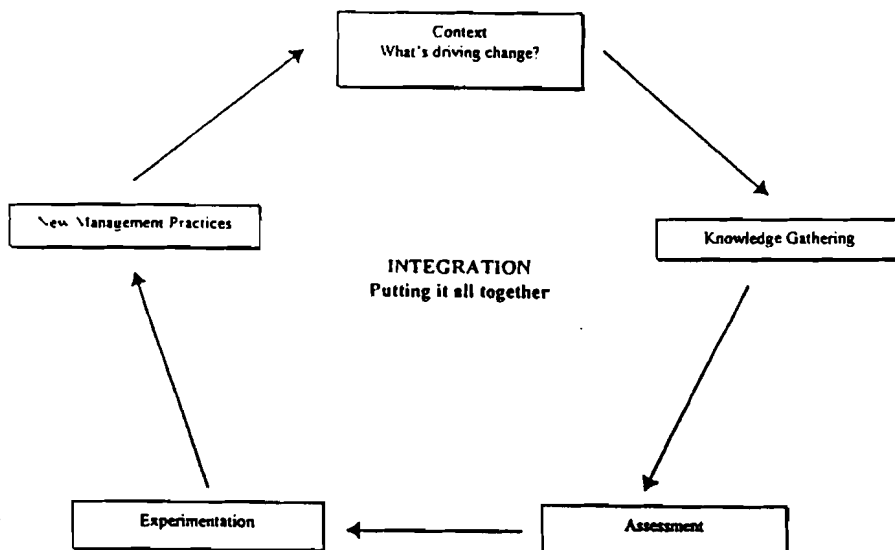

Context: Future Vision of Farming

Farmers presented mixed opinions on what dairying might look like in the future. The attitudes ranged from a positive outlook to “[farming] is not economically possible.” Several producers offered negative opinions about the future of small farms. Most believe that farms will continue to expand their herds. “I think you’re going to see more of the five hundred, thousand, fifteen hundred cows operations and, you know, the smaller operations are just gonna go by the wayside,” one said. Not all agree with an expansion oriented future vision. One farmer suggested, “I think there’s still going to be a place for so-called smaller herds around a hundred cows or less....with high production and people controlling costs and being able to repair things themselves.”

Key requirements for farms of the future include excellent farm management, high milk production, maintenance of low debt, existence of a manure management plan and controlling production costs.

The following table shows the percentage of farmers in our study who expect to be farming in ten years time divided into three age groups.

Table 2: Percentage of farmers who expect to be farming in ten years.

Age (years)	Expect to remain farming in 10 years			% of farmers who said Yes
	Yes	Uncertain	Total	
< 35	5	1	6	83
35 - 50	11	5	16	69
> 50	4	3	7	57
Total	20	9	29	69

Context: Fears of the Future

We asked farmers to identify their biggest fears as they think about the future of their own farms. Economic issues, not surprisingly, weighed heavily on the minds of most farmers in this study. They also worried about how regulations, particularly environmental regulations, will effect their ability to manage their farms. Manure management also presents a significant concern. Farmers feel a loss of control over their lives as they see outsiders, in the words of one, “being able to dictate how you run your operation.” Farmers worry about the influence of non-farmers in establishing regulations. The increasing number of urban/suburban people taking up rural residences concerns farmers who suspect that these new (non-agricultural) residents will be upset by the sounds and smells of their dairy farming neighbors.

Context: Views of the Environment

In our interviews we asked farmers to what extent they believed there was an environmental crisis. Opinions ranged widely from one extreme to the other. One farmer replied, “Oh, I think that there is a big environmental crisis.” Another disagreed: “Crisis? I would not say crisis. Ok. I would say concern. I would say it’s definitely something you gotta be aware of.” Another suggested, “I don’t think there is [an environmental crisis] right now.” Another felt “I guess from

this area I don't think it's a problem. Maybe in other areas." An increased awareness of pollution has made some farmers more careful about their own farms. Several farmers felt that the environment required attention but that the issue had been - in the eyes of one - blown "out of proportion."

Context: Environmental Awareness

Although farmers' opinions vary tremendously about the existence of an environmental crisis, they have become more aware of the environmental impact of their farm practices. Farmers gave examples of farm practices that might affect the environment in a positive or negative way in three areas; (1) reduction in the use of inputs such as pesticides, herbicides and fertilizers, (2) manure management practices such as daily spreading and (3) changes in tillage practices. The examples included farm practices they might have noticed on a neighboring farm or used on their own farm. Some farmers felt that chemical inputs are harmful or dangerous to the environment as can be seen by the following quotation. "You know, to grow, to get good yields, they really go heavy on the chemicals, which are very dangerous to the environment." On the positive side, another argued that "people are more careful."

When discussing manure management practices, more farmers felt that they and their neighbors often produced some negative environmental impacts. One said, "I have to spread during the winter. I know once the ground's thawed, that's gone, and it all washes down the creek." Liquid manure generated many comments including "liquid manure's a big problem." The issue of manure management, however, also relates to input use. Farmers gave many examples that showed how fertilizer use dropped as they paid more attention to how they spread manure. This farmer's comments illustrate that: "... last winter, we did a better job of spreading the manure and we didn't use any anhydrous [ammonia] last summer and we didn't see any difference in yield."

Many farmers, concerned about soil loss, reported that they have changed their tillage practices. The widespread use of strip cropping, grass waterways, chisel plowing, eliminating fall plowing, and reducing the use of the moldboard plow suggests an increased awareness and concern for soil resources. However, the major impetus for reducing inputs, we found, comes from economic pressures rather than environmental concerns. One farmer said it most clearly, "most of the decisions around here are based on economics and not concern for the environment."

Knowledge Gathering: Sources of New Ideas and Information

During the process of change, farmers set about gathering knowledge about the issue. We were curious about where farmers found new ideas and information about agriculture. Farmers get their information from a variety of places. The following sources were cited by participants:

Magazines

Other farmers

Seminars

Consultants: feed, crop, veterinary, financial

Salespersons

Organizations: Cornell Cooperative Extension, Farm Bureau, etc.

Non-farm friends

Personal experience - travel, involvement with dairy cooperatives, town councils, etc.

Assessment

Farmers draw on magazines as a useful and readily available source. They value this information but realize that care must be used in its application and interpretation. One said, "We have to keep an open mind, some of the articles are redundant and some are misguided, so you have to filter that out." Obtaining information, farmers told us, from multiple sources increases its reliability. "We ask everybody," said one farmer in explaining how she processed information. Farmers have mixed feelings about advice coming from salespeople. This farmer was "leery of their motives. I mean, their job depends on you buying something from them." Some, however, do obtain useful information from salespeople. Consultants selling information rather than products provide reliable information in some circumstances. Farmers analyze information from their numerous sources through discussion with their neighbors, their spouses, family members and business partners. In the words of one, "Well, I get bits and pieces here and there. I just sort of crunch everything and see what makes sense."

Experimentation: Implementation of New Management Practices

Experimentation often starts because of the presence of a particular problem. After gathering information from various sources, the farmer decides to move ahead and experiment with a new farming practice. The results of the experiment are evaluated and if positive the transition is made to incorporate the new practice into the farm management plan. Experimentation usually required adjustments and produced surprising results occasionally. For instance:

1. Initial yields from chisel plowing were lower; with experience they are now about equal.
2. Top quality alfalfa haylage; improved weed control because of chemical use.
3. Milk production decreased when the pipeline was shortened because milking intervals changed.
4. More efficient feeding from computerized feeding (feed went to the right cows).
5. Reduction in atrazine led to increased flexibility in crop rotation.
6. Milk production dropped with TMR and feed costs increased.
7. Contractor's sprayer boom didn't fit strip-cropped fields; farmer had to spray his own fields.
8. Sand bedding plugged pipe to manure storage forcing a change to rubber mattresses and shredded newspaper.
9. Bunker silage didn't freeze.

Implementation

Some examples of new practices tried by the farmers surveyed include:

1. rotational grazing,
2. liquid manure storage,
3. manure irrigation,
4. individual computerized feeding,
5. chisel plowing,
6. establishing strip-cropping,
7. pure alfalfa stands and
8. reduction in use of atrazine.

CASE STUDIES

The following two case studies, presented in the farmer's own words, describe two situations of change.

Building a New Heifer Barn

Larry[†], currently in the midst of a slow expansion of his dairy operation, is considering several options. Since he does not want to commit to expansion completely, building a new heifer barn seemed like his best choice. If he decides to continue expanding, the heifer barn will be utilized. If not, the heifer barn can be used to board heifers. Either way, the heifer barn remains useful.

I went down to Cornell and bought a book that was probably two inches thick on building free stalls and then we went to a bunch of neighbors that raise heifers and work with heifers and do implants and that stuff so we could get some dimensions on things that work. And we wanted to be able to have one person do anything that needs to be done, so its labor efficient that way. And the only thing we got out of that entire book was where to place the neck rail and uh the stalls themselves. Everything else came from the neighbors that are being used out in the field and how they work alone and have to do everything. That seems to work good for us. And I'm sure if it weren't for where the neck rail are we'd have problems with em getting caught in the stalls too. And we've never had a problem with that. We looked at putting head locks in the manger in the feed area but our feed area is not even classified big enough for being open let alone having the head locks take up more room. So uh we've put some in the stalls themselves and put em low enough so they can lay down cause we've heard all sorts of horror stories of other animals hitting em and knocking em down and having a dead heifer there, And we didn't want that. We made em low enough so they could lay down in there. I asked Ralph if anyone had ever heard of anybody putting head locks in stalls and they said never heard of that. And I said, well you wait a little while and maybe we'll see something. So I had em custom made and then put em in there they work really well. I do a lot of taping for size and I've only been kicked once or twice in the 7 years that it's been there. So I think that it's doing its job.

The phase of knowledge gathering shows clearly in this narrative. In this situation where a barn was being built, experimentation occurred differently from what can be seen in the second case study. Knowledge gathering becomes very important in this type of project. Larry did this in visiting with other neighbors who had built barns besides consulting the Cornell book. Although the book did not provide much useful information, the two pieces of information it did provide were key.

[†] Name has been changed to protect confidentiality.

Building a Bunker Silo

Harold[†] in this narrative, describes how he added the first bunker silo on his farm although initially he did not like “the looks of em” and had never considered building one.

Well, we needed another silo and the price of them had gone up, you know. So, well, course we always done a little excavating work and we had the bulldozer here, so we built our bunk when we reshaped the lot out for our free stall barn. In order to make drainage, you know, and everything, we had to cut down a little bit so we used that for the walls on our bunk silo. Worked perfect and we've got some concrete, bought some of em concrete slabs you know. And we used that dirt and built our own bunk that way, you know. It worked out good. Saved us a lot of money, but everybody don't have a bulldozer sittin around either. We built that for real cheap. In the first year we didn't know if we'd like it, so we just, we used dirt and we used plywood. And we said, well if we don't like it we could salvage some of the plywood and we can level the dirt out and it's all gone, it's over with. And we liked it. I never liked the looks of em. They always look messy to me, you know. You'd see a half bunk full of spoiled ensilage and oh, trucks parked in there and I didn't think I'd like em. So, I said to the boy, let's just try it for the first year. And man, we just loved it. It just worked out perfect. I think it's all in the way you manage em. So the next year we went ahead and got the concrete and concreted the floor, you know, the floor and set these slabs up and just built a dirt bank on each side of em. The way they're supposed to be built, this one we got, it's supposed to have like tripods to hold your cement slabs. You've probably seen. And they told us we couldn't do, we couldn't go that low with them tripods you know, them A frames, but, cause we had the equipment to do it so we done it and I like that better because the dirt, the edges don't freeze you know because you've got dirt on the outside of your concrete slab. And it don't freeze at all against the sides. It wasn't, that wasn't in the plan, but that's the way it worked out you know. It just works good.

Harold had never liked bunker silos. Because of the prohibitive cost of constructing another tower silo, he had to look at other options. Initially, he built a temporary bunk from plywood. If, after a year, Harold did not like it, the plywood could be removed and the excavation covered over. Only after trying out (experimenting) a temporary plywood bunk was Harold convinced that a bunker silo could work well on his farm. In contrast with the first case study, part of the knowledge gathering phase occurred during the experimentation phase. Harold does not describe how and where he obtained his initial information about building bunker silos.

[†] Name has been changed to protect confidentiality.

SUMMARY

Farmers are actively looking for new ideas. There are considerable ongoing farmer innovation and experimentation with new practices. Other farmers may be the most important source of information regarding new farm practices. Most of the farmers surveyed feel that economic pressures are increasing especially on small farms. Farmers are often felt left out of discussions regarding environmental issues. Many feel that they are being defined as the problem by people who do not understand the context. They believe that they are being regulated without being heard. Their concerns are ignored in the push to protect the environment.

The preliminary results suggest that the issues affecting farmers are very complex. The data need further analysis to help us better understand the process through which farmers make management decisions. Understanding this process will help agricultural scientists and extension educators provide useful information that will help farmers protect the environment while maintaining the viability of the dairy industry.

**Integrating Knowledge to Improve Dairy Farm
Sustainability Part X:**

Future Development of Computerized Decision Aid Tools

D.G. Fox, S.D. Klausner, M.C. Barry, R.E. Pitt, J.J. Hanchar and C.N. Rasmussen

ABSTRACT

In the course of the Dairy Farm Sustainability Project, it became evident that a large number of calculations must be made to obtain the data needed to make accurate nutrient management decisions. Accurate nutrient management decisions require accurate predictions of animal and crop requirements, surface and groundwater nutrient losses, and the economic impact of the management decisions on the farm. Thus, the next logical step is to develop a family of computerized decision aid tools which develop and evaluate nutrient management options considering animals, soils, crops and farm profitability.

In cooperation with the New York City Watershed project, we are currently: (a) developing simplified, user-friendly tools to assess nutrient management on dairy farms; (b) integrating information on crop production and rotation, soil fertility, animal nutrition, and economic and engineering considerations in assessing farm nutrient management; (c) providing information flow from the farm records into the decision aid tools by identifying the on-farm data which needs to be collected and developing the necessary on-farm record keeping systems; and (d) verifying the usefulness of these tools in farm assessments. Existing models to predict environmental losses of nutrients to groundwater and surface waters will be simplified for use in the data integration processes. This effort will assist in the application of computerized whole farm planning to large numbers of New York State farms.

INTRODUCTION

During this project, an interdisciplinary team worked through the process of weaving together many of the threads integral to dairy farm sustainability - farm profitability, crop and animal productivity and nutrition, impact of farm practices on water quality and farmer's perceptions of how their farming affects the environment. In developing this process, a tremendous amount of information was collected and integrated. Integrating this quantity of data was very time consuming. To make this type of analysis available to many farms in a timely fashion will require the development of a family of computerized decision aid tools.

The purpose of these tools would be to make dairy farms more economically and environmentally sustainable by increasing efficiency. As described in Part IX (Crosscombe and Ewert), the major impetus for reducing inputs comes from economic pressures rather than environmental concerns. Animal and agronomic nutrient management plans which decrease the net excess of nutrients on the farm (Part II, Klausner et al.; Part III, Hutson et al.) also increased predicted farm profitability on the two case study farms (Part IV, Rasmussen et al.). Partial budgets predicted that net farm income would increase because of more efficient use of nutrients both by the animals and crops. The development of tools which will promote animal and agronomic efficiency may have the double benefit of decreasing nutrient excess on farms and increasing farm profitability.

Nutrient management planning for dairy farms is important to the protection of water quality. Nutrient inputs to dairy farms typically exceed outputs, with the retained nutrients being subject to loss. Optimizing the use of nutrients in animal diets and manure and eliminating the use of excess commercial fertilizer are critical to improving the mass nutrient balance. A mass nutrient balance is a measure of a farm's overall nutrient status. Annual nutrient inputs are computed from the nutrient content in purchased feeds, fertilizers, biological nitrogen fixation,

and other miscellaneous inputs. Nutrient outputs are obtained for products sold such as milk, animals, and crops. The difference between inputs and outputs is the amount of nutrients retained on the farm that has to be managed. Previously, mass balances were calculated by hand with the aid of a workbook. Crop nutrient management planning, also done with the aid of a workbook (Part II, Klausner et al.), optimizes the distribution of manure nutrients on cropland while minimizing the risk of environmental loss. Animal nutrient use is analyzed with the Cornell Net Carbohydrate and Protein System (CNCPS) software, which predicts the nutrient supply and animal nutrient requirements for specific diets as affected by characteristics of the thermal environment, the animals, and feeds (see Part II, Klausner et al.). Nutrient losses from surface run-off and groundwater leaching are predicted using complex models (see Part III, Hutson et al. and Part VI, Houser et al.). Partial budgets were compiled by hand to evaluate the impact of the proposed nutrient management alternatives on farm profitability (Part IV, Rasmussen et al.).

It is critical to the accuracy of the nutrient management plan that farm specific data provide the basis for calculations. Current farm record keeping systems were inadequate to provide the inputs needed for each segment evaluated in this system (Part I, Fox et al.). An accomplishment of this project was the identification of what information has to be collected at the farm level to provide the data for whole farm/nutrient management planning. This information must be made available to the computerized tools. A front-end data entry section which shares farm data among the decision aid tools will be programmed. On-farm record keeping systems which collect and summarize this information must be identified and modified as necessary or developed.

Objectives

1. Develop user-friendly computerized tools to assess nutrient management on dairy farms and to help develop whole farm plans. This integrated system of nutrient management tools is called the Cornell Nutrient Management Planning System (CNMPS).
2. Integrate information on crop production, soil fertility, animal nutrition, economics, and engineering considerations into the CNMPS.
3. Identify on-farm data which will be needed as inputs for the CNMPS and develop an on-farm record keeping systems to collect the necessary data.
4. Verify the usefulness of these tools in farm assessments.

METHODS

The CNMPS consists of 5 integrated components, namely; 1) Mass Nutrient Balance, 2) Nutrient Management Planning for Crop Production, 3) Animal Nutrient Management, 4) Crop Rotations and 5) Economic Evaluation. The Mass Nutrient Balance software has been developed first because it is an initial indicator of a farm's overall nutrient status. The Animal Nutrient Management component is being developed simultaneously based on the existing Cornell Net Carbohydrate and Protein System. Nutrient Management Planning for Crop Production requires a decision making component regarding the distribution of manure. The Crop Rotation component provides a linkage between the animal and soil/crop components and will be developed in the future. An economic evaluation of the plan will also be developed. A common data entry area will provide farm data to all of the components.

A key issue in the development of computerized tools is their ease of use. Therefore, significant effort has been devoted to 1) choosing the operating system and software development programs that provide the platform for these tools, 2) making the tools self explanatory and convenient to use, 3) basing the inputs on readily available information, and 4) testing the software by potential users. A testing sequence has been implemented at four levels: internal testing during development, in-house testing by Cornell experts, limited testing in the field, and wide-scale testing in the field.

RESULTS TO DATE

Initial development and field use of the Mass Nutrient Balance and the Animal Nutrient Management software and the development and initial testing of the Crop Nutrient Management software are the major accomplishments to date. The first version was programmed in FoxPro to handle the extensive data bases. It became evident after testing that the Fox Pro version had errors, and problems with ease of making corrections and changes. An additional problem is the inability to link it with the Animal, Crop Rotation, and Economic components. To overcome these problems, we have moved to Microsoft Excel as a common platform. The Mass Balance and Nutrient Management Planning programs have been re-programmed into one Excel program. Initial evaluations indicate that it is much easier to update and is more user friendly. A beta version is now ready for field testing.

The next step will be to field test the beta Excel version of the Mass Balance and Crop Nutrient Management software. Eighteen individuals agreed to test the software in a "real world situation" by using it to develop nutrient management plans for a farm in their region. The individuals doing the initial testing are comprised of a mixture of Cooperative Extension agents, private farm consultants, and special project personnel for several agricultural watershed projects. At the completion of their review, revisions will be made accordingly. This software will be used by the National Resource Conservation Service (NRCS) in New York State.

The next programming step will be to program the Animal Nutrient Management software, which is now a stand alone cattle ration evaluation program, into a whole herd version in Excel. The animal requirements component is nearing completion. Linkage with the other components is scheduled to begin in the last quarter of 1996.

One of the goals of the CNMPS is to develop nutrient management plans which make the farm more sustainable - environmentally and economically by utilizing nutrients more efficiently. To evaluate the most efficient allocation of resources, a economic component needs to be an integral part of the CNMPS. A model developed by Schmit et al. (1994) will be used as the basis of the economic evaluation component. This model incorporates enterprise budgeting analysis and linear programming to define and describe the whole farm system with various components (soil, crops, animal, water quality and economics). When included in the CNMPS, this component will predict the impact of various combinations of crops, herd sizes, feeding systems, crop inputs and water quality constraints have on net farm income. The economic component of the CNMPS is currently in the planning and development stage.

DISCUSSION

Nutrient management involves the integration of many aspects of a farm operation. An assessment of the pathways of nutrient movement is a good starting point to understand nutrient cycling. The outcome of the assessment can be used to determine management options that increase the potential to recycle nutrients from the animal to crop and back to the animal again with minimal loss. Establishing a nutrient management plan requires an understanding of 1) the movement and quantity of nutrients entering, leaving, and remaining on the farm; 2) nutrient requirement of the crop rotation; and 3) distribution of nutrients to meet crop requirements.

Nutrients normally concentrate on livestock farms because more are brought onto the farm than leave as products sold. Although the percentage of nutrients retained on the farm is not related to farm size, the actual amount of nutrients that have to be managed does increase with farm size. Therefore, an increase in animal numbers requires a corresponding increase in cropland acres or manure should be transported to farms with a nutrient deficit.

Not all the retained nitrogen can be recycled through the crop production system because a significant amount can be lost by ammonia volatilization from manure and by denitrification and leaching. Retained phosphorus accumulates in soil and may be lost from the farm in runoff, erosion, and leaching. An accumulation of phosphorus in soil will be reflected in the long term increase in soil test phosphorus level. Soil testing is a basic requirement of nutrient management. Nutrients in manure cannot be substituted for fertilizer on a pound-for-pound basis because they are not as readily available nor can they be as efficiently timed and placed as those in fertilizer. Management of manure nutrients is critical to maximize their fertilizer replacement value and to protect water quality.

Because a large percentage of imported nutrients is in purchased feeds, ration formulation has a significant impact on a farm's nutrient status. Changes in the types of feeds purchased, the balance between forage and concentrate, and the ratio of corn silage to hay crop can affect substantially the imports of purchased feeds. These changes can also affect crop nutrient management and other sources of imported nutrients. For example, crop acreage may change as the feeding program is adjusted, thereby affecting fertilizer imports. Also, the nutrient composition of the manure is affected by animal nutrition, thereby affecting the fertilizer replacement value of manure. The development of integrated software for crop rotations will need to take these interactions into account.

The next focus of this project will be to develop the whole herd cattle nutrition program in Excel so that it can be easily used to develop site specific feeding programs that accurately match available home grown feeds with cattle requirements. The goal is to improve animal performance while reducing imported nutrients. To accomplish this goal, nutrient requirements and supply of nutrients available to meet these requirements must be computed from inputs available on each unique farm, including animal (body weights, mature size, body condition score, amount and composition of milk), environmental (temperature, wind, animal insulation factors), and feed factors (intake of each feed and the physical and chemical composition of each, including feed carbohydrate and protein fractions and particle size). The cattle nutrition model then computes the animal requirements for each group of cattle being fed in that unique situation, and the user can determine how best to match available feeds with each group of animals on the farm and accurately determine minimum amounts of supplemental feeds that must be purchased for each. The program then computes total herd feed requirements and nutrients excreted, which then is

passed to the Crop Nutrient Management, Crop Rotation, and Economic Software.

Thus the Cattle Nutrition model is the “heartbeat” of the system, and all other components depend on its accuracy. The program being used as a base (The Cornell Net Carbohydrate and Protein System) is unique in its capability to meet these objectives. In tests on case study Farm A, use of the current version reduced nitrogen excretion 1/3 (Part II, Klausner et al.) while reducing annual feed costs \$42,000 (Part IV, Rasmussen et al.). Phosphorus loss was also reduced substantially, because imported protein supplements, which contain high levels of phosphorus, were reduced (Part III, Hutson et al.). The Cornell model is becoming an International “Gold Standard” model for this purpose, and is being used as a structure for the model developed for the New National Research Council Nutrient Requirement Recommendations for Beef Cattle that is being released in June 1996. It is being used in its present form by Dairy Nutritionists across North America, and in Europe, Latin America, and Australia. As far as we know, the whole herd version being developed for this project will be unique both nationally and internationally.

The development of tools for crop nutrient management, animal nutrient management, crop rotations and farm profitability analysis will provide an integrated family of tools for site-specific nutrient management on dairy farms. These tools will be second to none in their ability to minimize nutrient losses from animal and crop production, which is the first step to protecting water quality on livestock farms.

REFERENCES

- Schmit, T.M., and W.A. Knoblauch. 1994. The impact of nutrient loading restrictions on dairy farm profitability. *J. Dairy Sci.* 78:1267-1281.

DAIRY FARM SUSTAINABILITY PROJECT PUBLICATIONS

- Crosscombe, P. World view of dairy farmers. Cornell University MS Thesis. Publication Pending.
- Fox, D.G., S.D. Klausner, T.P. Tylutki and J.J. Hanchar. 1994. Cows, crops and cash: making dairy farms sustainable. Proceedings of the 1994 Cornell Nutrition Conference. pp 47-55. October 18, 1994.
- Fox, D.G., S.D. Klausner, T.P. Tylutki, J.J. Hanchar, and C. N. Rasmussen. 1995. Integrated nutrient management to improve the sustainability of livestock farms. p. 4-13. *In Proc. Agriculture and People - Building a Shared Environment.* 9-10 Oct. Univ. of Nebraska, Lincoln, NE.
- Fox, D.G., C.N. Rasmussen, R.E. Pitt, J.J. Hanchar. 1996. Integrating knowledge to improve dairy farm sustainability - part I: objectives, procedures and lessons learned. (submitted).
- Hutson, J.L., R.K. Koelsch, R.E. Pitt, and R.J. Wagenet. 1996. Integrating knowledge to improve dairy farm sustainability III: environmental losses and nutrient flows. (submitted).
- Klausner, S. 1995. Nutrient management planning. In: *Animal Waste and the Land-Water Interface.* pp 383-392. Lewis publishers. CRC Press, 2000 Corporate blvd., NW. Boca Raton, FL.
- Klausner, S. 1995. Nutrient management: Crop production and water quality. Bul. 95CUWFP1. Dep. Soil, Crop, and Atmospheric Sci. Cornell U., Ithaca, NY.
- Klausner, S.D., D.G. Fox, T.P. Tylutki, W.C. Stone, L.E. Chase, and R.E. Pitt. 1996. Integrating knowledge to improve dairy farm sustainability II: plant and animal nutrient management. (submitted).
- Klausner, S., S. Telega, and N. Leonard 1995. Estimating a mass nutrient balance. Bul. 95CUWFP1.1. Dep. Soil, Crop, and Atmospheric Sci. Cornell U., Ithaca, NY.
- Klausner, S., and R. Halbohm. 1995. Nutrient management workbook. Bul. 95CUWFP1.2. Dep. Soil, Crop, and Atmospheric Sci. Cornell U., Ithaca, NY.
- Malvicini, C. et al. 1994. Integrating knowledge to improve the sustainability of dairy farms in New York State Progress Report - Phase 1 December 1, 1993 to September 30, 1994.
- Pitt, R.E. 1995. Nutrient flows on dairy farms: a case study. 1995. Proceedings of the 1995 Cornell Nutrition Conference. p. 153-160.

- Rasmussen, C.N., J.J. Hanchar, and P.E. Wright. 1996. Integrating knowledge to improve dairy farm sustainability IV: economic evaluation of alternatives to improve nutrient efficiency. (submitted).
- Stone, W., L. Chase, D. Fox. 1994. Field applications of the Cornell Net Carbohydrate and Protein System Model in a Progressive Dairy Herd. Proceedings of the 1994 Cornell Nutrition Conference. pp 168-179. October 18, 1994.
- Warner, F. 1994. Farming better will mean getting it all together. Cornell Focus v. 3 no. 3. November 3, 1994.
- White, K. 1995. Environmental assessment: case study farm. Ind. Study project. ABEN 497. May 1995.

Dairy Farm Sustainability Project Contributors, 1993-1995

Principal Scientists	Title
Danny Fox, Chair	Professor, Animal Science
Larry Chase	Assoc. Professor, Animal Science
Debbie Cherney	Sr. Research Assoc., Animal Science
Jerry Cherney	Professor, Soil, Crop, and Atmos. Sci.
Merrill Ewert	Asst. Professor, Education
John Hutson	Sr. Research Associate, Soil, Crop, and Atmos. Sci.
Stuart Klausner	Sr. Extension Associate, Soil, Crop, and Atmos. Sci.
Wayne Knoblauch	Professor, Ag., Resource, & Managerial Econ.
Rick Koelsch	Asst. Professor, Bio. Sys. Engineering, U. of Nebraska
Alice Pell	Assoc. Professor, Animal Science
Ron Pitt	Professor, Ag. & Bio. Engr.
Keith Porter	Director, NYS Water Resources Institute
Susan Wade	Sr. Research Associate, Vet. Diagnostic Lab
Jeff Wagenet	Professor & Chair, Soil, Crop, and Atmos. Sci.
Keith Waldron	Sr. Extension Associate, Int. Pest Mgmt.
Peter Wright	Sr. Extension Associate, Ag. & Bio. Engr.

Staff	Title
Kathy Barrett	Cornell Cooperative Extension Agent
Mike Barry	Nutritionist, Animal Science
John Hanchar	Economist, Ag., Resource, & Managerial Econ.
Cindy Malvicini	Coordinator, Center for the Environment
Caroline Rasmussen	Economist, Animal Science
Stephanie Schaff	Research Associate, Vet. Diagnostic Lab
Tom Tylutki	Nutritionist, Animal Science
Judy Wright	Cornell Cooperative Extension Agent

Students	Area of Study
Pat Crosscombe	World View Study, Education
Jim Houser	Data Synthesis and Modeling, Ag. & Bio. Engr.
Julie Monaco	Manure Sampling and Losses, Ag. & Bio. Engr.
William Stone	Dairy Cattle Nutrition, Animal Science
Kimberly White	Environmental Assessment, Ag. & Bio. Engr.

The Dairy Farm Sustainability Project Team wishes to express their sincere appreciation and thanks to the farm owners and managers of the two participating case study farms. To maintain the confidentiality of information provided in this report, these individuals will remain unnamed but their help and time has been extremely valuable and greatly appreciated.