

February 1987

A.E. Res. 87-6

INVENTORY CONTROL IN A NEW YORK APPLE PACKING PLANT

S. A. Starbird
R. A. Milligan
G. B. White
L. W. Schruben

Department of Agricultural Economics
Cornell University Agricultural Experiment Station
New York State College of Agriculture and Life Sciences
A Statutory College of the State University
Cornell University, Ithaca, New York 14853

It is the policy of Cornell University actively to support equality of educational and employment opportunity. No person shall be denied admission to any educational program or activity or be denied employment on the basis of any legally prohibited discrimination involving, but not limited to, such factors as race, color, creed, religion, national or ethnic origin, sex, age or handicap. The University is committed to the maintenance of affirmative action programs which will assure the continuation of such equality of opportunity.

TABLE OF CONTENTS

	<u>Page</u>
1. INTRODUCTION	1
The New York State Apple Packing Industry	2
Objectives of the Research	2
Organization of the Report	4
2. THE APPLE PACKING SYSTEM	5
Production Stages of the Apple Packing System	5
The Apple Packing Plant	8
The Economics of Apple Storage	8
The Decision to Store	9
The Decision to Sell	12
The Case Plant	16
3. MODEL AND METHODOLOGY DESCRIPTION	20
Simulation Analysis	20
Description of the Model	22
Scope of the Model	22
Assumptions, Constraints, and Parameters	23
Storage Allocation Policies	26
Performance Measurement	28
Data Sources and Model Validation	30
Data Sources	30
Model Validation	34
Experimental Design	34
Spectral Analysis	39
4. SIMULATION RESULTS	46
The Effect of Alternative Storage Control Policy	46
Options on System Performance	46
Under the Original Parameter Values	46
Under an Alternative Discount Function	54
The Effect of Non-Stationary Expected Order Rate	54
on System Performance	54
The Effect of Additional Controlled Atmosphere	61
Storage Facilities on System Performance	61
The Effect of Changes in Orchard Composition	63
on System Performance	63
An Evaluation of the Use of Spectral Analysis to Measure	65
the Relative Importance of System Inputs	65
5. SUMMARY, LIMITATIONS, AND FUTURE DIRECTIONS	68
LIST OF REFERENCES	72

LIST OF TABLES

<u>Table</u>	<u>Page</u>
2.1.1 Average Annual Production of Top Seven Apple Varieties Produced in New York State, 1978-82	7
3.2.1 1985 Controlled Atmosphere Room Capacities, Room Allocations and Opening Dates for the Case Plant	25
3.3.1 Results of the Goodness-of-Fit Test on Empirical Density Functions Used in the Simulation Model	32
3.3.2 Expected Revenue from Apples Stored in Controlled Atmosphere Storage During the 1984-85 Season	35
3.3.3 Comparison of Revenue Expectations of Seven Simulation Runs with 1985 Case Plant Revenue	36
3.4.1 Expected Excess Orders for Each Variety	40
3.5.1 Results of Spectral Analysis of the Model	45
4.1.1 System Performance Under Each Policy Alternative	47
4.1.2 Analysis of Variance in Total Lost Premium	49
4.1.3 Analysis of Variance in Total Lost Sales	50
4.1.4 System Performance Under Each Policy Alternative Under an Exponential Discount Function	51
4.1.5 Analysis of Variance in Total Lost Premium Generated by an Exponential Discount Function	52
4.1.6 Analysis of Variance in Total Lost Sales Generated by an Exponential Discount Function	53
4.2.1 System Performance Under a Non-Stationary Expected Order Rate with a Maximum at 112.5% of the Expected Order Rate	55
4.2.2 System Performance Under a Non-Stationary Expected Order Rate with a Maximum at 125% of the Expected Order Rate	56
4.2.3 Analysis of Variance in Total Lost Premium Generated Under a Non-Stationary Expected Order Rate (112.5%)	57
4.2.4 Analysis of Variance in Total Lost Sales Generated Under a Non-Stationary Expected Order Rate (112.5%)	58
4.2.5 Analysis of Variance in Total Lost Premium Generated Under a Non-Stationary Expected Order Rate (125%)	59
4.2.6 Analysis of Variance in Total Lost Sales Generated Under a Non-Stationary Expected Order Rate (125%)	60
4.3.1 System Performance Under Alternative Storage Capacity Options	62
4.4.1 System Performance Under Alternative Orchard Compositions	64
4.5.1 Signal to Noise Spectral Ratios Under Original and Optimal Control Policies	66

LIST OF FIGURES

<u>Figure</u>		<u>Page</u>
1.1.1	Apple Acreage in the State of New York, 1982	3
2.1.1	Stages of the Apple Production System	6
2.3.1	Storage Supply Curves	11
2.3.2	Firm's Supply Curve for Apples Stored Under Controlled Atmosphere	13
2.3.3	Demand Curves for Apples of Various Ages	15
2.3.4	Interaction of Supply and Demand for Fresh and Aged Apples	17
2.3.5	Combined Interaction of Supply and Demand for Fresh and Aged Apples	18
3.2.2	SLAM II Flow Chart of the Simulation Model	24
3.3.1	Empirical Cumulative Distribution Function for Mcintosh Order Size	33
3.4.1	Expected Order Rate under Non-Stationary Demand	38

1. INTRODUCTION

The producers of apples in the state of New York are facing increased competition from out-of-state producers. This competition is based upon the producers' ability to grow, pack, and market a high quality apple on a timely basis. For New York producers to successfully compete, they must utilize state-of-the-art practices to maintain their efficiency relative to that of the growers in the competing regions [White, p.116].

The efficient use of scarce production resources can never be assumed by a conscientious manager or production economist. Leibenstein (1966) presents strong empirical evidence suggesting inefficiency is more likely due to the firm's inability to fully utilize resources ("X-inefficiency") than to the sub-optimal allocation of resources due to monopoly distortions (allocative inefficiency). If a firm is allocatively inefficient, social welfare is not optimized because the marginal value signals derived from prices and quantities are distorted by monopoly power. If a firm is X-inefficient, social welfare is not optimized because resources are not utilized as fully as possible [Leibenstein, pp.397-407].

X-inefficiency is caused by management with imperfect information or labor which is unmotivated. If management possesses imperfect information, X-inefficiency is manifested through the development of sub-optimal operating policies. If labor is not motivated, X-inefficiency is manifested through the dilatorious execution of operating policies (optimal or not).

In the apple packing firm, management cannot use controlled atmosphere storage facilities to the best of its ability because the true production function is unknown. Managers of CA storage simply do not know what their facilities are capable of producing. Since the full potential of their CA facilities is unknown, managers do not know if they are using optimal control policies or whether they need to search more thoroughly for an optimal solution.

Evidence exists which suggests that there are X-inefficiencies associated with the operation of CA facilities by apple packers in New York State. For example, there appears to be no consistency among similar apple packers with respect to how CA capacity is allocated or when CA rooms are opened. Also, there is no consistency with respect to the best number of CA rooms to maintain. These inconsistencies imply that either the optimal use of CA storage is different for similar firms, e.g. the objective function may be different, or that the optimal use is unrecognized by the firm.

One of the motivations for this research is the evidence suggesting managers of storage facilities in apple packing plants have imperfect knowledge of the potential performance of those facilities. By examining alternative control policies for apple inventories, the full potential of CA storage may be revealed and suitable adjustments in management policies may be enacted.

The goal of this research is to disclose any inefficiencies associated with the current CA room control policies and suggest improvements in the control policies that may enhance the competitive ability of New York apple producers. The disclosure that CA facilities are not used to their full potential under current control policies implies the need for the reform of these policies. The examination of alternative policies will then suggest the source of the inefficiency and adumbrate the direction of improvement.

In the first section of this section, the New York State apple packing industry is described. In the second section, the objectives of the research are enounced. The organization of this report is presented in the final section.

1.1 THE NEW YORK STATE APPLE PACKING INDUSTRY.

Apples are New York's single most important fruit product. The annual value of apple production in New York averaged \$101 million over the period from 1979 to 1983. This production accounted for sixty-five per cent of the total value of fruit production in New York over this same period and about three per cent of total agricultural receipts. Nationally, New York ranks second with 12.6 per cent of total utilized production of apples. Fresh apple sales account for thirty-nine per cent of this production [White, p. 113].

In 1980 there were 1,183 farms growing apples in the state of New York. Most production occurs on the larger farms, i.e., the largest 17% of the farms accounted for 62% of the production in 1980. Production is concentrated in three areas of New York: the Hudson Valley, the Champlain Valley, and Western New York (see Figure 1.1.1). Many of the firms growing apples also operate a packing house and storage facilities. Some firms are vertically integrated to the point of maintaining a sales force [White, pp. 115-116].

The major markets for New York's fresh apples are the Eastern Seaboard and the Upper Midwest. However, New York's share of these markets has been decreasing over the last several years [White, p. 113]. Many reasons are given for this loss, but the ability of the competition, principally growers in the state of Washington, to consistently produce and market a high quality apple on a timely basis is fundamental. According to White (p. 119), quality is the number one problem of New York's fresh apple industry.

Two trends in the industry promise to increase the importance of storage control policies. First, the annual production of apples in the United States is likely to exceed the annual demand for apples by the year 2000 [White, p. 118]. Second, the number and capacity of CA storage facilities has been and will continue to increase [USDA]. These trends imply that competitive apple packers will use CA storage for an increasing portion of their product in order to exploit off-harvest season demand.

Furthermore, currently popular distribution channels force packers to confront a highly stochastic demand. If packers continue to use these channels, then they must continue to manipulate an acutely constrained supply to meet a highly stochastic demand for quality apples. The prudent apple inventory manager must enhance his or her competitive position by utilizing the best possible CA inventory control policy.

1.2 OBJECTIVES OF THE RESEARCH

The general objective of this research is to examine controlled atmosphere (CA) storage control in an apple packing plant and to determine whether the full potential of these facilities is being realized. This general objective was divided into three specific objectives of the research:

NEW YORK STATE

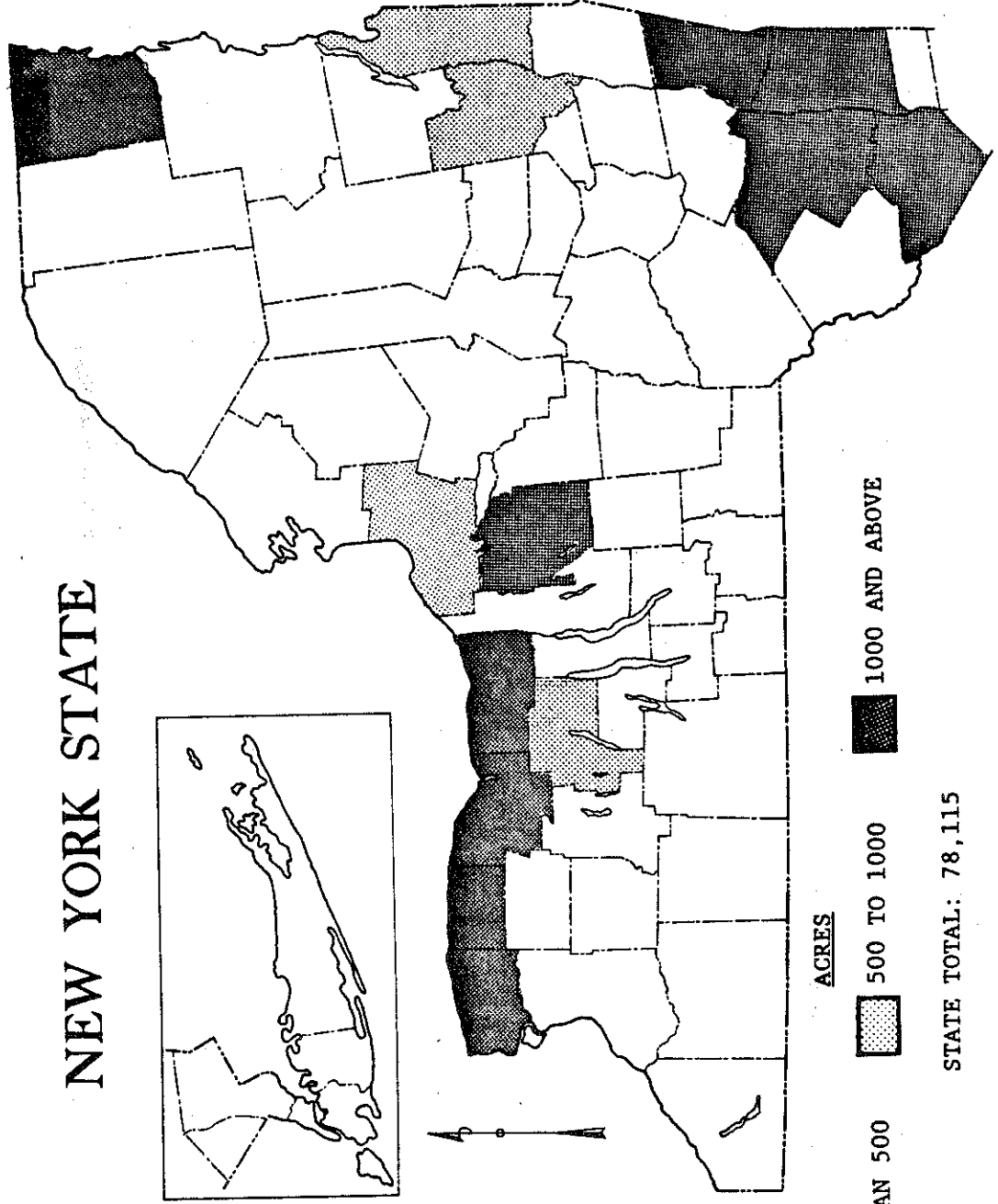
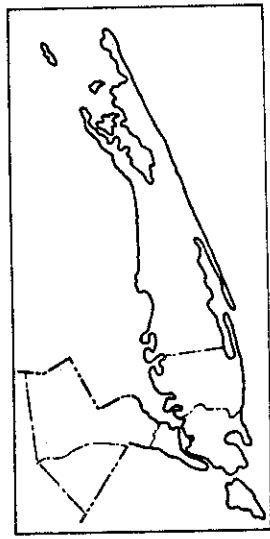

STATE TOTAL: 78,115

FIGURE 1.1.1. APPLES ACREAGE IN THE STATE OF NEW YORK, 1982.

- (1) To identify the best CA storage control policy for a variety of demand patterns with a given number of CA facilities.
- (2) To identify the best number of CA storage facilities to utilize under the best storage policy.
- (3) To identify the best allocation of production resources among apple varieties under the best storage policy.

The first objective of the research is to identify the best CA storage control policy for a New York apple packing plant under various demand patterns. To help achieve this objective, an apple packing firm located in the Hudson Valley of the state of New York is used as a case study. A single plant is studied instead of several plants because identifying an optimal policy for several plants inappropriately assumes that these firms act together. This assumption is highly unrealistic and the situation is unlikely to change [White, p. 113]. In order to extrapolate the results to a broader range of operating parameters, i.e., a broader range of firms, the sensitivity of the results to changes in demand pattern and storage configurations is considered.

The second objective of this research is to identify the optimal number of CA rooms the firm should utilize under the optimal control policy. The size and number of CA storage rooms maintained by the firm is one parameter that varies between firms. The total CA storage capacity in the U.S. increased 36% from 1983 to 1985 indicating the growing popularity of this type of storage [USDA, p.1]. The distribution of this capacity into individually sealed rooms is of critical importance to the apple packer. Utilization of a larger number of rooms increases the flexibility of the firm in meeting the stochastic demand for apples.

The third objective of the research is to identify the effect of reallocating production resources to fewer varieties. The number of varieties grown by the firm is another parameter that varies between firms. New York producers grow a myriad of varieties, while highly successful growers in the state of Washington are concentrated around fewer varieties. This objective seeks to identify whether a New York grower can benefit significantly from consolidating resources to the production of fewer varieties.

1.3 ORGANIZATION OF THE REPORT

In this section, the problem facing apple packers with respect to inventory control was described and the objectives of the research were presented. In section two, the apple packing system from growing through distribution, the apple packing plant, the economics of apple storage, and the case plant are described in detail.

In section three, the model and methodology are described. First, the use of simulation is justified. Second, the scope, design, and construction of the simulation model are detailed. Third, the sources of data used to construct the model and validate its use are presented. The design of experiments and a description of spectral analysis complete this section.

In section four, the results of the experiments are presented and some conclusions are drawn concerning the operation of the case firm. Finally, in section five, the research is summarized, limitations are listed and several future research directions are suggested.

2. THE APPLE PACKING SYSTEM

In this section, the production stages of the apple packing system and the apple packing plant are described. The economics of apple storage and the characteristics of the case plant are also presented.

2.1 PRODUCTION STAGES OF THE APPLE PACKING SYSTEM

For the purposes of this research, the apple packing system is defined as the channels, operations, and stages through which apples are grown, packed, and finally distributed to consumers. Figure 2.1.1 offers a representation of the principle production stages of this system.

The first stage within this system is growing. Several varieties of apples are grown in New York state. The principal variety in New York is McIntosh which is followed in importance by Red Delicious and Red Rome. Table 2.1.1 presents the average annual production of the top seven apple varieties grown in New York, 1978-82.

The apples mature in the late summer and fall, depending upon the weather, variety, and age of the orchard. Most firms grow several varieties of apples and are, therefore, harvesting throughout this period. Harvesting is performed by hand using local and migrant labor.

Some apple growing firms retain ownership of the apples throughout the next few stages of the system while some firms sell their apples after harvest. The owner of the apples after harvest has three alternatives. The apples can be packed immediately, be put into refrigerated storage, or be put into controlled atmosphere (CA) storage. The choice depends upon the intended market for the apples. Apples packed immediately are sold immediately. Apples put into refrigerated storage are sold in two to four months. Apples put into CA storage are sold in three to ten months. Bins of apples (approximately 20 bushels per bin) are removed from refrigerated storage to meet orders as they arrive. There are no state or federal regulations regarding the use of refrigerated storage.

Apples put into CA storage are not easily accessible. Since the atmosphere of CA facilities is controlled, CA rooms must be sealed. It takes approximately fourteen days after the rooms have been sealed for the atmosphere to reach the required 5% oxygen. In New York, the state regulates several activities with respect to CA rooms. First, rooms containing McIntosh must be sealed ten days after the first McIntosh apple arrives in the room. Second, the rooms containing McIntosh must reach 5% oxygen with twenty days after they are sealed. Third, all rooms must be sealed at least ninety days before they can be opened.

Once the rooms are opened, the apples must be packed. The apples begin to deteriorate as soon as they are exposed to the regular atmosphere. Technically the rooms could be resealed, but by the time the atmosphere reaches 5% oxygen again, many of the apples would have significantly deteriorated.

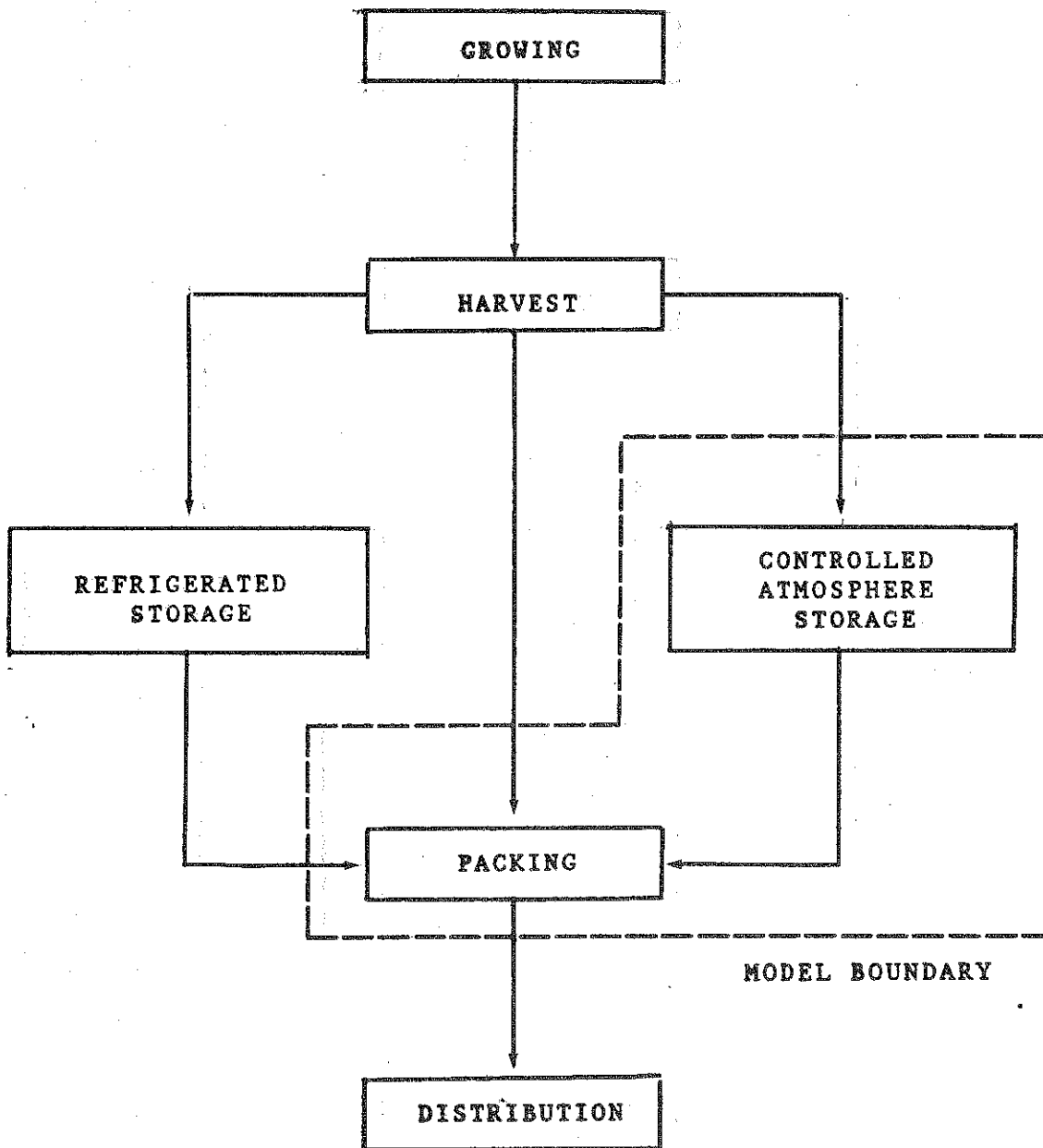

FIGURE 2.1.1. PRODUCTION STAGES OF THE APPLE PACKING SYSTEM.

TABLE 2.1.1. AVERAGE ANNUAL PRODUCTION OF THE TOP APPLE VARIETIES
PRODUCED IN THE STATE OF NEW YORK, 1978-82.

VARIETY	AVERAGE ANNUAL PRODUCTION (million bushels)	PERCENT OF TOTAL NY PRODUCTION
McIntosh	7.0	28.9
Red Delicious	3.1	12.8
Romes	3.0	12.4
Rhode Island Greening	2.9	12.0
Cortland	1.9	7.8
Golden Delicious	1.4	5.8
Ida Reds	1.4	5.8

SOURCE: G.B. White, "Economic Opportunities for Fruit."
New York State Agriculture 2000 Study. Albany, N.Y.:
New York State Department of Agriculture and Markets,
1984, p.2.

Most firms produce a variety of packs depending upon the grade of the apples. Grades are differentiated on the basis of color, size, and condition of the fruit. Lower grade apples are packed in bags which are then boxed (a box is approximately one bushel). Higher grade apples are usually waxed, packed in trays or cells, and then boxed. Trays come in a variety of sizes that correspond to different size apples. Generally, larger apples bring a higher price. At the retail level, bagged apples are sold by the bag, while boxed apples are sold by the pound.

The apples are not packed until they are matched with orders. If the firm maintains a sales force, orders are received at the packing plant. If not, the firm may sell its apples through a broker. Daily contact between the broker and the plant is necessary to match orders with pack types and varieties. The apples may be sold f.o.b. the plant, or may be distributed through transportation affiliated with the packing firm (see Figure 2.1.1).

2.2 THE APPLE PACKING PLANT

The activities performed in the plant include dumping, destemming, washing, waxing, sorting, sizing, and packing. These activities may differ between firms depending upon equipment and varieties.

The dumping activity is the unloading of bins of apples into a water tank. Apples are floated between activities through flumes. The dumping activity may be manual or automatic.

The destemming activity removes stems, leaves, dirt, and any other material other than apples from the system. This activity is usually mechanical and involves a series of rotating brushes.

The washing and waxing activities are performed on apples intended for trays and not on apples intended for bags. These activities are mechanical.

The next activity is sorting. This activity is manual and involves removing utility and cider grade apple from the flow. Usually a rotating table is employed to aid the sorters. Some firms employ an electronic color sorter. The percentage of apples culled from the line depends upon the apple variety, the cultural practices of the firm, and the weather. The percentage can range from three to thirty-five per cent. Of course the number of employees needed at the sorting table depends in large part on the expected percentage culls.

The sizing activity is performed mechanically by a series of belts with ascending sized mesh. Therefore smaller apples are withdrawn from the flow first. The size determines the pack type more than anything else. Several tray sizes can be used ranging from 120 count to 64 count (i.e. 120 apples per box to 64 apples per box).

Finally, the apples are packed. In most firms packing is manual for trays and partially mechanical for bags. Different size apples are channeled to different rotating tables where employees load trays with apples and boxes with trays. Packed boxes are refrigerated while awaiting shipment.

2.3 THE ECONOMICS OF APPLE STORAGE

In the previous sections, the production stages of the apple packing system were described and the activities performed within the apple packing plant were presented. This section presents an economic interpretation of

the management decisions made by apple packers and the framework within which these decisions are made.

The packing house manager makes storage decisions at two different times and in two different venues. First, the manager must decide how much of existing storage capacity to utilize. This decision is typically quite inflexible due to the conditions described below. Second, the manager must decide when to sell the stored apples, i.e., when to open the CA rooms. Both of these decisions necessarily rely less on market conditions than on the status of the firm.

2.3.1 The Decision to Store. In marketing theory, price differences between products are thought to be coincident with form, spatial, and temporal differences between products. Specifically, in equilibrium, the cost of transferring a product from one form to another, one location to another, or one time to another is equal to the difference in the price of the product before and after the transformation.

The temporal dimension varies slightly from the other dimensions in that temporal transfers can only be made forward in time. Price differences between today's product and yesterday's product are not directly relevant in the decision to exploit intertemporal price differentials in the future. The temporal dimension also differs from the others in that the name given to exploiting intertemporal price differences is speculation while exploiting price differences in other dimensions is called arbitrage [Bressler and King, p.211].

Agents speculate in the temporal dimension by storing products. The cost of storing a product from one period to another equals the difference in price between the periods if the market is in equilibrium. Of course speculators prefer a disequilibrium that will generate a profit. For speculators trading commodities for which futures markets exist, calculating returns to storage can be approximated by the differences in spot and futures prices [Working, p.1255]. Speculators dealing in other commodities must use other sources of information to determine whether to store.

For apple packers, the decision to store apples is particularly difficult for several reasons. First, a futures market for apples does not exist and current marketing channels do not support the establishment of forward contracts. Under these conditions the variance in returns to storage increases. Second, most apple packers have several varieties competing for the same storage space. If a forward contract were available, good estimates of the relative expected returns to storage could be used to allocate storage capacity. Third, apples are perishable and deteriorate within a matter of days. The apples must be sold during the marketing season regardless of whether or not expectations are realized. Finally, poor storage policies can cause apples to deteriorate and therefore lose value before intertemporal price differentials can be exploited. In this case, prices may be realized that would generate favorable returns to storage if the product form and location remained unchanged. However, a poor storage policy can cause the apples to deteriorate and therefore offset the favorable storage speculation with an unfavorable change in product price due to changes in product form. Therefore, speculating in practice, on the temporal dimension of the fresh apple market is complicated by the several varieties (products) produced and by the effect of storage control policies on product form (quality).

Even though these characteristics of the fresh apple market increase the risk of generating a favorable return to storage, apple packers continue

to store large quantities of apples. This action may be due to large potential profits. However, if the temporal dimension of the market is near equilibrium, other reasons must be pursued.

Working (1949) suggested a number of reasons why the supply of storage is not zero when potential profits are less than or equal to zero. First, the costs associated with storage are principally fixed costs. Therefore, even if expected returns are negative, expected return over variable costs may be maximized by speculating. Second, storage costs tend to be joint costs. Most CA storage facilities are a component of a vertically integrated enterprise that includes orchards, packing equipment, and a sales force. Therefore, losses to storage may be offset by profits at other stages of the production process. Finally, there are intangible benefits to maintaining a "convenience yield", i.e., using the storage facilities simply to keep the channels open. If some product is not available during the CA marketing season, customer goodwill may be lost [Working, pp. 1260]. Therefore, even though expectations may be low, risky, or both, storage facilities may be used.

Figure 2.3.1(a) represents a storage supply curve for the apple market that is consistent with the principles noted above. The quantity of storage supplied is greater than zero when the returns to storage are zero because of fixed costs, joint costs, and convenience yield. The supply curve bends upward at some point, representing the physical limitation on storage in a given period of time.

The supply curve for storage in a single firm is inelastic for the same reasons that positive amounts of storage are utilized when the expected profits from storage are zero. First, most apple packing firms are vertically integrated enterprises including growing, harvesting, storage, packing, and sales. The firm is more concerned with the returns to the whole operation rather than an individual stage of production. Therefore the quantity of CA storage utilized is likely to be affected by many factors in addition to the expected returns to storage. Second, the variable costs associated with CA storage are small compared to the fixed costs. Therefore, a very small expected return per unit stored will induce the firm to utilize a substantial portion of the available storage. Third, buyers of New York apples generate a demand all year round. Although packers can sell all apples on the fresh market, the firm's relationship with other buyers may be sacrificed by not having supplies available in the Winter. Therefore, the firm is motivated to maintain a convenience yield.

These characteristics imply that the individual firms supply curve for storage is inelastic as shown in Figure 2.3.1(b). Of course the units of measure on the abscissa in Figure 2.3.1(a) is several times higher than the units of measure on the abscissa in Figure 2.3.1(b).

This representation of the supply curve for storage implies that while the decision to store is an important one, the inelasticity of the supply curve makes the set of choices small. Furthermore, the efficiency with which CA storage is utilized is not likely to be significantly improved by choosing the amount of storage to use more efficiently.

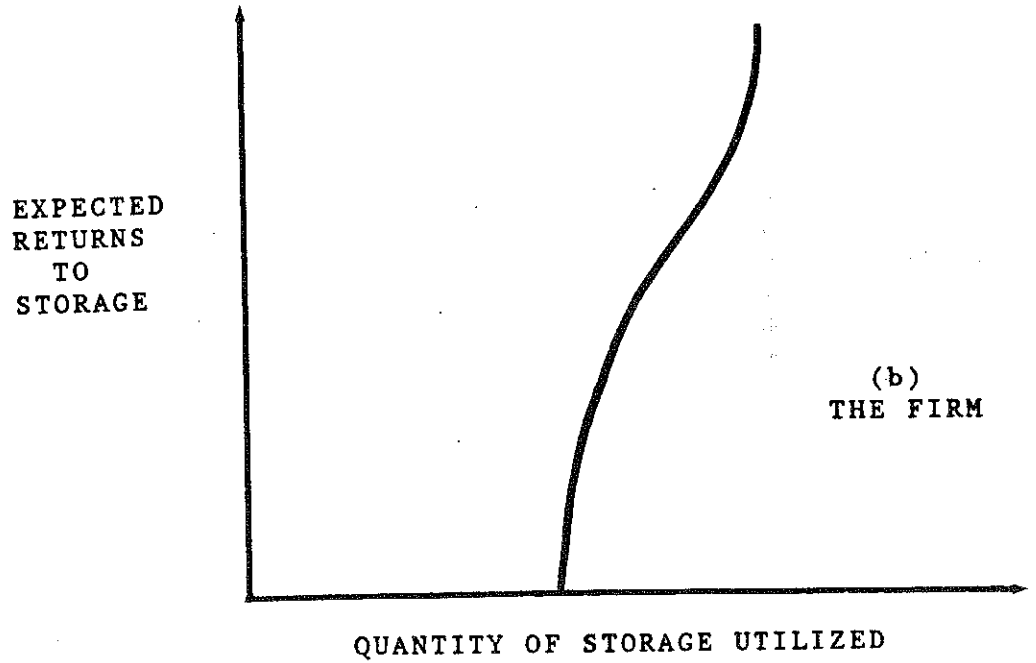
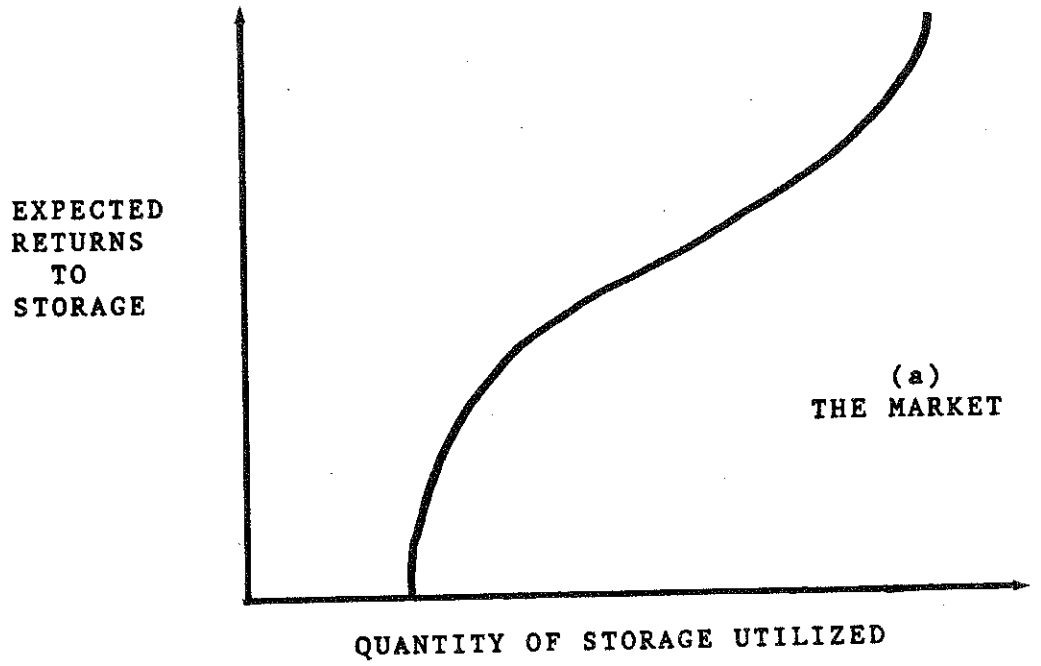

FIGURE 2.3.1. STORAGE SUPPLY CURVES FOR THE MARKET (a) AND A FIRM (b).

2.3.2 The Decision to Sell. In the previous section, the decision to store was shown to depend less on expected returns to storage than on the quantity of storage that the firm has available. In this section it is shown that the decision to sell should not necessarily be based upon market price.

At the end of the storage period, the firm must determine when to supply apples, i.e., when to open the CA facilities. By the time the manager is faced with this decision, most storage costs are sunk. Sunk costs are costs that have been incurred and cannot be recovered. Therefore, sunk costs should have no bearing upon current decisions [Garrison, p.39].

The supply curve for CA stored apples should not reflect these sunk storage costs but should only reflect the risk associated with opening additional storage facilities. From many years of experience, the firm's management knows that all the firm's apples cannot be sold at the market price. However, the firm is aware that the product market is not perfectly competitive and so only a limited quantity of apples can be sold during any period.

The uncertainty inherent to an imperfectly competitive market translates into risk for the firm. Since CA rooms cannot be resealed, apples supplied but not sold may deteriorate in value as their quality deteriorates. Of course, as the observed price gets higher, the firm may be more likely to accept this risk. The firm's supply curve, therefore, resembles the discontinuous segments represented in Figure 2.3.2(a). At prices below p_1 the firm is unwilling to supply any apples because of the miserable expected return. They would much rather wait in the expectation that prices will improve. The price p_1 is the threshold that stimulates the firm to open one CA room. The CA room contains q_1 units of apples. The firm is reluctant to risk additional apples until the price reaches p_2 at which time the firm will open another CA room containing $q_2 - q_1$ units of apples. A downward pressure is exerted on the threshold values by the costs associated with keeping the storage sealed. These costs include the costs of maintaining CA conditions, the costs of deterioration while the apples are in storage, and the costs of sales lost because the rooms are closed. This downward pressure increases as the marketing period progresses and orders can be met with early ripening varieties.

The supply curve in Figure 2.3.2(a) represents the quantities of "fresh" CA apples the firm will supply at various prices. Consider, however, the market for "aged" CA apples. Suppose due to market imperfections that the firm cannot sell all it has on hand for a period of time. Then the apples have aged and must be sold in a different market. The firm's supply curve for aged apples is perfectly inelastic because the firm realizes that costs are incurred by not selling apples, i.e., the apples are continuously deteriorating (Figure 2.3.2(b)).

Because of the number of imperfect substitutes and the importance of non-price competition in the apple market, it can be described as monopolistically competitive. The market for apples includes many products that are imperfect substitutes for one another. The characteristics which differentiate the products are variety and quality. In New York state over fifteen different fresh apple varieties are grown and marketed. These varieties are imperfect substitutes for one another in the eyes of most consumers. Quality also differentiates between products. Some firms grow quality fruit due to careful orchard management, others do not. Quality is also influenced by the age of the apples. Apples recently removed from CA storage are of a higher quality than apples left on the dock for several days.

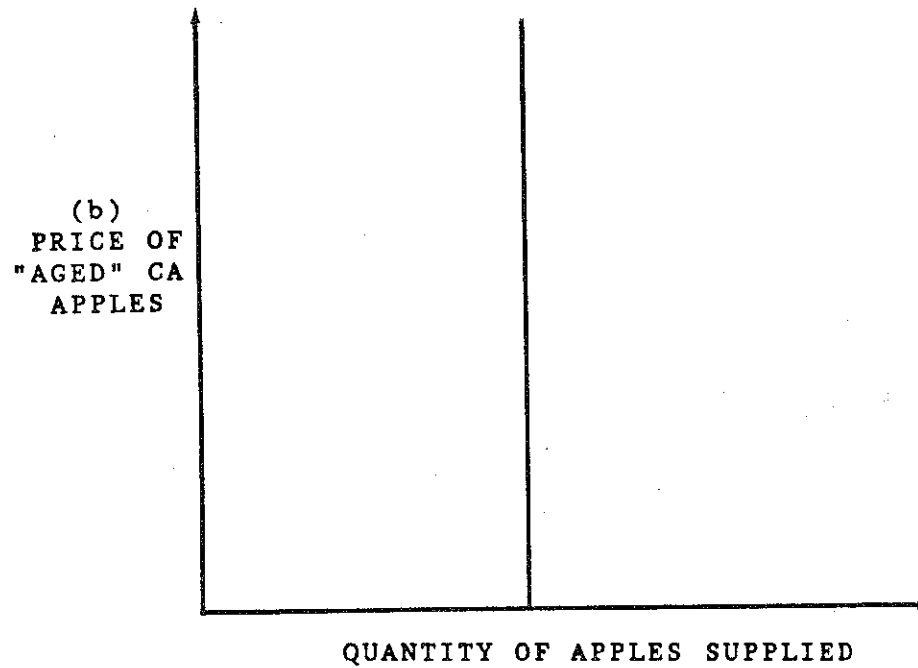
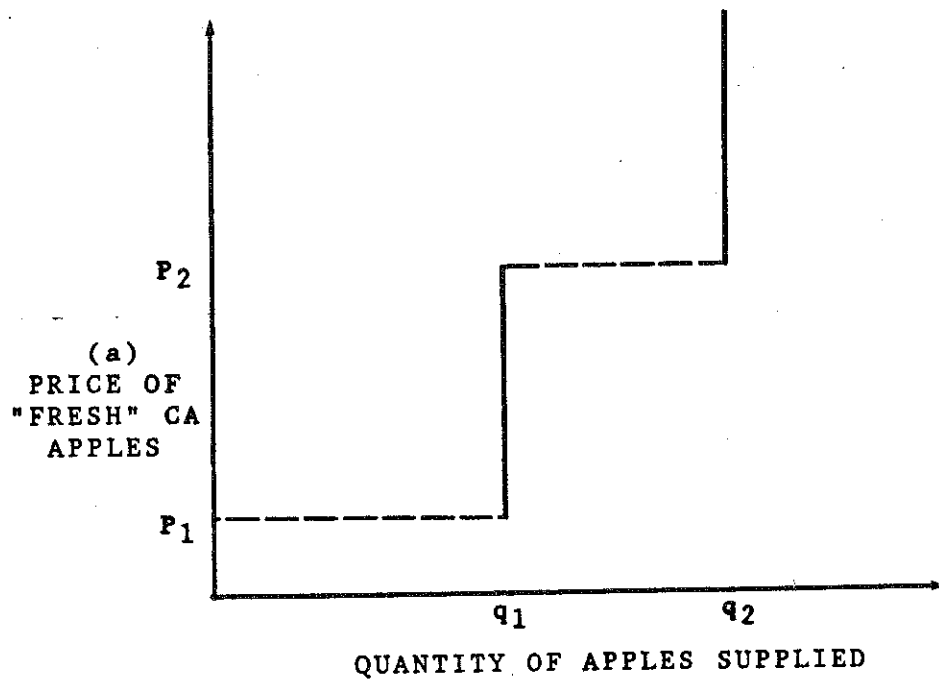

FIGURE 2.3.2. THE FIRM'S SUPPLY CURVE FOR (a) "FRESH" CA APPLES AND FOR (b) "AGED" CA APPLES.

The many apple products are not only imperfect substitutes for one another in the market, they are imperfect substitutes for one another in the firm. Most firms grow and pack several different varieties of apples so their products are differentiated in that way. Similarly, the firm is unlikely to be able to sell all "fresh" CA apples because of market imperfections, so their products are usually differentiated by quality associated with age.

The incidence of non-price competition in the market also supports the hypothesis that the market is monopolistically competitive. Non-price competition takes the form of tacit agreements, traditional prices or customers, advertising, etc. The object of non-price competition is to alter the shape of the firm's product demand curve by making competition "personal". Recall that "impersonal" relations between buyers and sellers is a necessary condition for perfect competition [Ferguson and Gould, p.314].

The evidence suggests strongly that the market for apples in New York is monopolistically competitive. Therefore, the firm faces a less than perfectly elastic demand curve. Furthermore, the exact shape of the curve is a function of the composite behavior of the other firms in the market.

A firm facing a monopolistically competitive product market has some degree of control over price due to non-price competition. However, the actual shape of the demand curve (and therefore the marginal revenue curve) facing the firm is as affected by the actions of other firms controlling imperfect substitutes as by the control of non-price competition. These effects will carry over into the market for older apples also. Figure 2.3.3 shows the relationship between the demand for fresh CA apples (d_0), for apples aged one period (d_1), and for apples aged two periods (d_2). These curves may or may not be parallel depending upon market conditions. However, for a particular firm with supplies of the same variety of apple of different ages, it is easy to argue that older apples are valued less than the newer apples.

The firm makes its supply decision in an environment that is highly volatile and uncertain. In a perfectly competitive market, the firm sells all it can at the market price in the long-run. In the short-run, the firm is limited to its proportion of market demand in perfect competition. For example, if the equilibrium price is p , the equilibrium quantity demanded is Q , and there are n firms in the industry, then the firm can expect to sell Q/n in the short-run and generate revenue equal to $p(Q/n)$ if the market is perfectly competitive [Chamberlin, pp.113-6]. However, this market is monopolistically competitive so the demand for a firm's apples in a given time period depends in great part on what other firms are supplying during that same period and what residual supply of older apples is on the market.

The volatility of the demand implies that the firm is extremely unlikely to generate an equilibrium supply. Consider the case illustrated in Figure 2.3.4(a). This firm faces a price that is determined in the aggregate market. The demand curve for fresh CA apples is completely unknown to the firm because of its dependence upon the actions of the rest of the industry. The firm observes a price (p_0) and opens two CA rooms; supplying q_0^s units of apples. The actions of the industry generates a demand curve for the firm's product (d_0). In this period the firm sells q_0^d at p_0 generating a revenue of $p_0 q_0^d$ and a residual supply of $q_1^s = q_0^s - q_0^d$. In the next period (Figure 2.3.4(b)) the firm will unload q_1^s at any price, so the supply curve is perfectly inelastic (S_1). The market generated price is p_1 and the demand for this firm's apples aged one period is q_1^d . At this point the firm

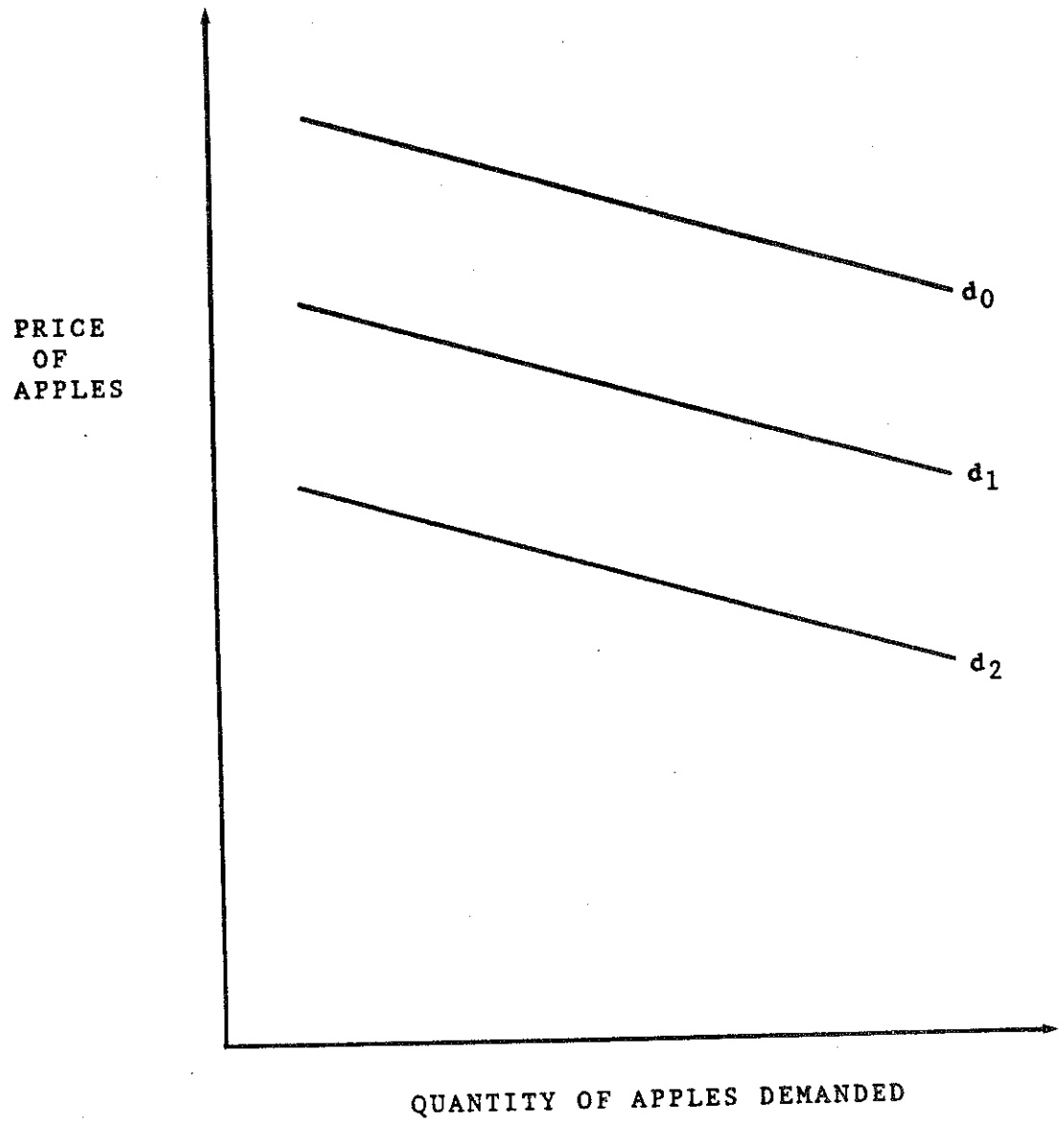

FIGURE 2.3.3. DEMAND CURVES FOR APPLES OF VARIOUS AGES.

generates revenue of $p_1q_1^d$ and a residual supply of q_2^s . In the next period (Figure 2.3.4(c)) the demand is higher than the residual supply and a revenue of $p_2q_2^s$ is generated. These three periods are combined in Figure 2.3.5. In this figure the area $Op_0Aq_0^d$ is the revenue generated in period 0; the area $Op_1Bq_1^d$ is the revenue generated in period 1; and the area $Op_2Cq_2^s$ is the revenue generated in period 2.

Empirical evidence suggests that the case firm used in this research rarely sells all its apples soon after a CA room is opened. This phenomenon is not unusual considering that the firm's costs are incurred by keeping the CA rooms closed and that demand is not that lumpy. As a result the firm is tempted to open rooms and therefore over-supply the "fresh" CA market.

From the economic conditions within which this firm operates, one can see that there are currently few advantages to considering market price in the decision to open CA rooms. The demand curves d_0 , d_1 , and d_2 are highly volatile and depend in great part on factors outside the control of the firm. If the firm could control or, at least, estimate these demands (as the firm might be able to do in a marketing cooperative) then the market price would become a significant indicator of policy. However, until the firm can make fairly accurate estimates of demand, price should have little effect on decisions. Instead, there may be a pattern to the volatility in price and demand that may support a policy based on inventory conditions. Some recurring well-defined policy may, by its recognition of the stochastic nature of demand, improve the system's performance.

In this section the economic framework within which the management of apple packing facilities makes decisions was described. In the next section, the case plant used to study the objectives stated in section 1.2 is presented.

2.4 THE CASE PLANT

In order to attain the objectives stated in section 1.2, a single firm was chosen as the focus of the study. In many ways this firm is representative of a successful New York apple packer so any inefficiencies present in the case plant are likely to exist in other segments of the industry also.

The firm is a family owned partnership located in the Hudson Valley region of New York state. The firm grows over ten different apple varieties on five farms. The firm's primary interest is the fresh market, but of course it generates a quantity of processing apples as a byproduct.

The firm maintains and operates a plant with several CA rooms and a packing line. The CA rooms range in size from 2,700 to 15,000 bushels. The location of the plant is central to the growing regions. Travel time from the farms to the plant is negligible.

Seven varieties (McIntosh, Rome, Red Delicious, Empires, Golden Delicious, Spartans, and Ida Reds) make up 95% of the firm's product. In 1985 the firm used ten CA rooms to store about 110,00 bushels of its own product and about 4,000 bushels for other growers. The total annual pack has ranged from 190,000 to 230,000 bushels during the last five years.

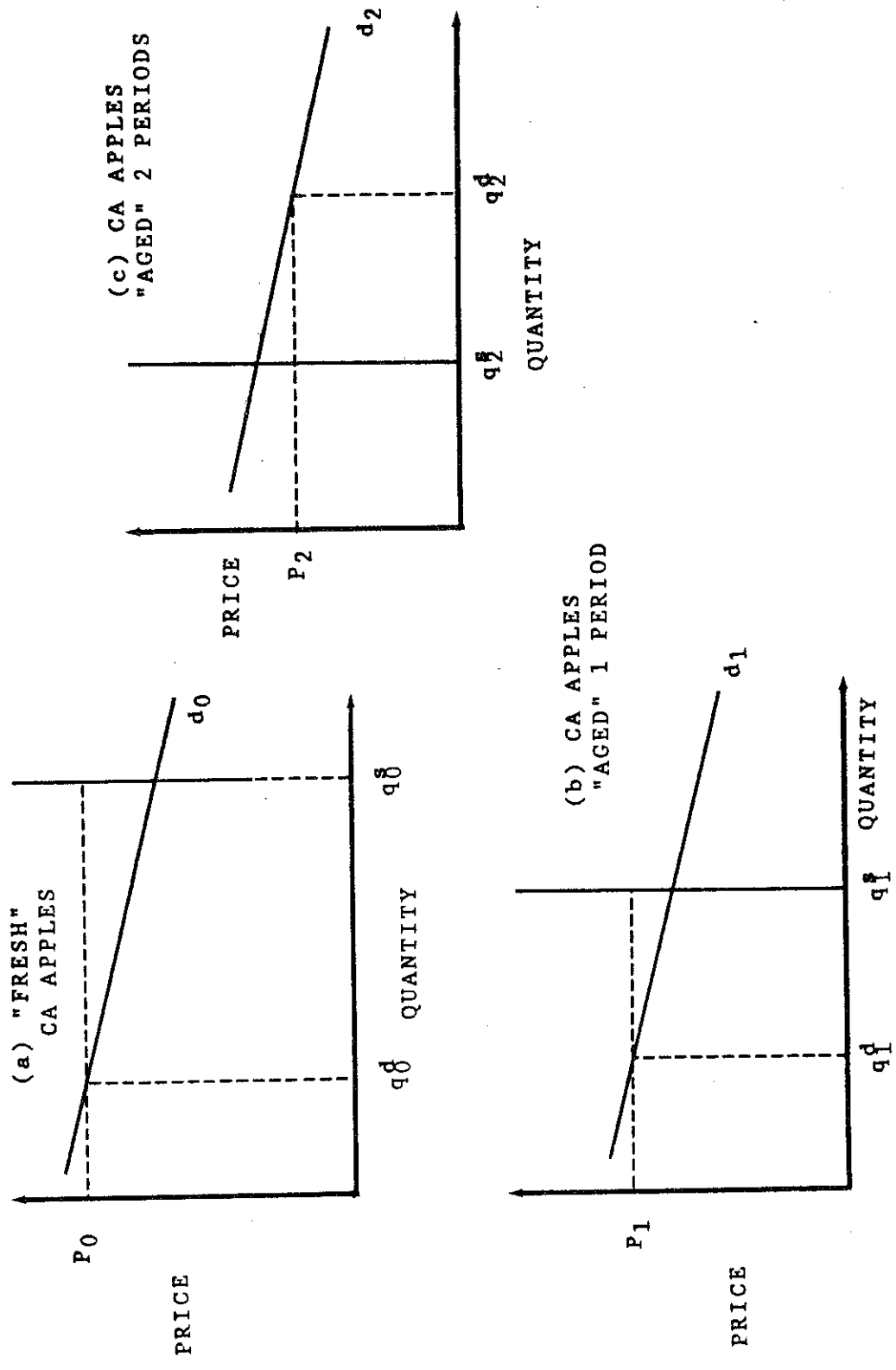

FIGURE 2.3.4. INTERACTION OF SUPPLY AND DEMAND FOR (a) FRESH CA APPLES AND (b,c) AGED CA APPLES.

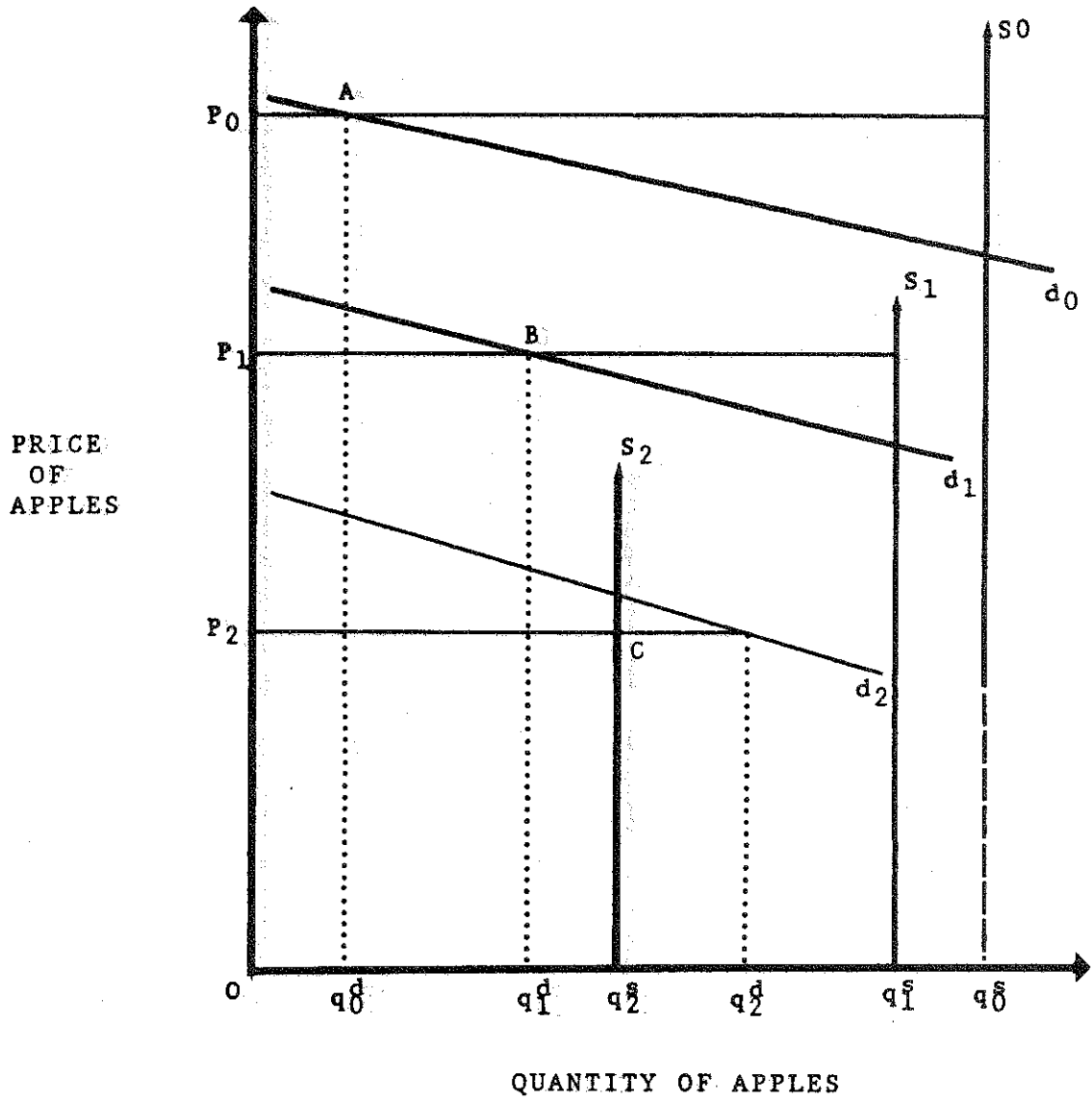

FIGURE 2.3.5. COMBINED INTERACTION OF SUPPLY AND DEMAND FOR FRESH CA AND AGED CA APPLES.

The firm produces about twenty different pack types and has a reputation for quality in the industry. All sales are performed by a broker, under the broker's label. However, institutional purchasers frequently request the case plant's product.

The firm is in daily contact with the brokerage to plan daily operations. Because of the perishability of the product, the number of varieties, and the number of different packs, operations are kept flexible to meet the stochastic orders.

In this section the apple packing industry, the apple packing plant, the economics of apple storage, and the case firm used in this research were discussed. In the next section the model used to achieve the objectives and the method used to analyze the model are presented in detail.

3. MODEL DESCRIPTION AND METHODOLOGY

In Section two, a description of the apple packing system including a description of the case plant was presented. In this section, a description of and justification for the model, a description of the data sources, and the results of the model validation are presented.

3.1 SIMULATION ANALYSIS

The objectives of the research, stated in section 1.2, involve the analysis of the performance of an operating firm under a variety of different policies and configurations. The first objective concerns the performance of the system under alternative storage allocation policies. The second objective involves alternative fixed asset configurations, i.e., controlled atmosphere room numbers. The third objective also involves alternative fixed asset configurations, i.e., orchard composition.

The objectives can be met by altering the case plant and recording the effect of the alteration on the performance of the plant. This alternative has several disadvantages. First, the cost of making the alterations to the existing plant and examining the performance of the plant under these alternatives is prodigious. Second, only one observation can be made each year. Third, there are significant uncontrollable random factors inherent to "real-world" system.

An alternative is to construct a model of the case plant and evaluate the effect of changes in policy and configuration on the performance of the model. The effect of the changes in policy on the existing plant can then be inferred from their effect on the model.

Models can be scaled physical objects, mathematical equations and relations, or graphical representations [Pritsker, p.2]. The choice of the modeling medium is a function of the objectives of the modeling process. The objectives of the research involve the alteration of two types of system parameters: operating policy and physical plant. The relationship of these parameters to the performance of the system can be described better by mathematical equations and relations than by graphical or physical representations.

Mathematical equations and relations cover a broad field of techniques. In a simple system, where the relationship between variables and deterministic parameters is well defined, one would develop a set of equations defining this relationship. The equations could then be altered to examine changes in parameters or optimized in an attempt to identify an analytical solution. Some complex systems, however, have characteristics that make the definition of a set of mathematical equations impractical. These characteristics include (1) few available fundamental laws, (2) procedural elements that are difficult to describe or represent, (3) policy inputs that are difficult to quantify, (4) significant random components and (5) significant human decision making components [Pritsker, p.3]. For systems that exhibit these characteristics, the numerical solution procedure of simulation is more appropriate than an analytical solution procedure.

Several characteristics of the apple packing system make a simulation model preferable to an analytical model. First, the apple packing system has significant random components associated with order rates, order sizes, and prices. Second, the policy options are complex and difficult to quantify.

Third, the control of the controlled atmosphere storage facilities is based on daily human decisions. Fourth, certain procedural elements, particularly the queuing of supplies and of orders are difficult to represent.

In a simulation analysis, a system is evaluated numerically, i.e. data from the system is collected and used to estimate the characteristics of the system. Some of the advantages of simulation are as follows [Law and Kelton, p.8]:

1. Simulation can investigate a system for which analytical evaluation appears impossible, i.e., for systems that either cannot be represented by a set of well defined equations, or for which a set of representative equations cannot be solved.
2. A simulation model can estimate the performance of an existing system under a projected set of operating conditions. In the case of the apple packing plant, the effect on system performance of a variety of projected demand patterns can be deduced from the simulation model.
3. A simulation model can estimate the performance of the system under a variety of different designs or configurations, i.e., changes in the parameters defining the plant's physical characteristics can be evaluated.
4. A simulation model can estimate the performance of the system under a variety of different operating policies, i.e., changes in the parameters defining the policies governing the operation of the plant can be evaluated.
5. The process of constructing a simulation model can yield important information and help define data collection or research needs [Hsaio and Cleaver, p.435].

Simulation also has several disadvantages. Some of these disadvantages are as follows [Law and Kelton, p.8-9]:

1. Simulation models are extremely complex, time-consuming to develop, and expensive to run.
2. A simulation is a numerical procedure, so only estimates of a system's true characteristics are generated.
3. A simulation model may create unjustified confidence in its results because of its complexity, i.e. a simulation model that is not valid is of no use regardless of its complexity

The characteristics of simulation make it ideal for meeting the broad objectives of this research. The first objective is to examine several alternative operating policies under changing order rates. One of the advantages of simulation is its ability to estimate the performance of a system under changing operating conditions. The second and third objective involve evaluating the effects of changing the number of CA rooms and orchard composition, respectively. Another advantage of simulation is its ability to estimate the performance of the system under changing configurations or designs.

There are many programming languages available for constructing computer based simulation models; such as GASP, SIMSCRIPT, or SLAM II [Law

and Kelton p.114]. The language SLAM IItm developed by Pritsker and Associates of West Lafayette, Indiana was used to model the apple packing plant considered in this research. SLAM II (Simulation Language for Alternative Modeling II) has several advantages, including versatility and flexibility. SLAM II is versatile in that it can model interactions between the continuous, discrete event, and network components of simulation models [Pritsker, p.74]. SLAM II is flexible in that changes in the model's structure can be implemented quickly and easily.

The popularity of simulation, and of SLAM II, has grown in recent years, particularly in the area of the modeling of food processing and packaging systems. For example, Shah *et al.* (1983) examined modifications in the design of a sausage manufacturing plant using a simulation model coded in SLAM II. Starbird and Ghiassi (1986) examined alternative operating policies in a multi-product tomato processing plant using a simulation model coded in SLAM II. Also, Logan (1984) studied aggregate planning for a multi-plant food processing firm using a simulation model coded in FORTRAN. These studies are indicative of the growing interest in simulation as a method of analyzing the production economies and policies of agricultural firms.

3.2 DESCRIPTION OF THE MODEL

In the preceding section, the justification for using a simulation model was presented. In this section the model is described in detail. Section 3.2.1 describes the scope of the model. Section 3.2.2 focuses on the assumptions, constraints, and parameters used to develop the model. A definition of the storage allocation policies is given in section 3.2.3 and the means of measuring model performance is described in section 3.2.4.

3.2.1. Scope of the Model. Figure 2.1.1 is a schematic representation of the stages of fresh apple production. Production begins with the growing stage and ends with distribution to consumers. The objectives of this research, enounced in section 1.2, define the scope of the simulation model, i.e. determine which stages of fresh apple production are included in the model.

The first objective of the research involves the controlled atmosphere (CA) storage allocation policy used by the firm and the second objective concerns the number and capacity of CA storage facilities. Therefore the model centered on the activities occurring in the controlled atmosphere storage stage. The regular storage stage is not included in the model because allocation of raw product between regular and CA storage is assumed to be a function of price expectations and not within the scope of this research.

The third objective of the research is to identify the best orchard varietal composition for a range of demand patterns. The growing stage is included in the model in the sense that the total quantity of each variety available for storage is determined by the firm's orchard composition. Changing the total quantity of each variety available for CA storage in the model simulates changes in the firm's orchard composition.

The grading operation of the packing stage is included in the model because it affects the quantity of each variety available to meet orders. During the grading operation, utility and cider grade apples are "graded-out" or culled. The probability that an apple is culled depends upon the apple's variety. Some varieties simply generate more utility grade apples due to the

characteristics of the variety. However, other factors, such as weather during the growing stage also influence these proportions.

The distribution and harvest stages are not included in the model. The distribution stage is not included because it has little or no effect on the ability of the firm to fill orders. The harvest stage is not included because it would add little to the validity of the analysis. The inclusion of the harvest stage could, potentially, add one component to the analysis: a measure of the difference between the time the apples are harvested and the time the apples are fully under CA conditions. One might be able to use this information to determine whether a particular policy is feasible with respect to state regulations or a threshold quality level. However, the state regulations apply to only one variety of apples, McIntosh, and little is known about the rate of deterioration of different varieties of apples. Therefore, the simulation model would be very difficult to validate, i.e., it would be difficult to find data with which to compare the simulation results to measure the model validity. Because of the difficulty in validation, it would be presumptuous to draw conclusions regarding the feasibility of the storage allocation policies from the results of simulating the harvest stage of the system.

3.2.2. Assumptions, Constraints, and Parameters. Figure 3.2.2 is a schematic representation of the SLAM II^{cm} simulation model of the case plant. The model's structure parallels that of the case plant described in section 2.4. The model simulates the activity of ten controlled atmosphere storage rooms ranging in capacity from 4,700 to 15,000 bushels. The capacities of each room, the 1985 allocation, and opening dates are presented in Table 3.2.1.

The computer program of the model is divided into a network component and a subroutine component. The network component is coded in SLAM II and represents the arrival of orders, the opening of CA rooms, the matching of orders with supplies, and the packing operation. The subroutine component is coded in FORTRAN IV and is the source of random variables for price and the interarrival times of bin demands.

Three control variables define the rate at which supplies become available: CA room opening dates, CA room capacity allocations, and the distribution of varieties among CA rooms. It is assumed that (1) CA rooms classified as soft or hard cannot be reclassified, (2) the CA room opening sequence cannot be changed, and (3) the "other" varieties, those owned by other firms and stored by the case plant, or those accounting for less than 1% of total revenue, can be stored in any of the rooms. The policies control when the CA rooms are opened, not the sequence; which varieties are more important within a CA room; and how the SH varieties (varieties having both hard and soft variety characteristics) are distributed between the two CA room types.

A random variable representing the price of each variety is generated each simulated day. All transactions on the day occur at the generated price. Discounts are also derived from this price. A random variable representing the interarrival time of each bin demand is generated as needed, i.e., when an order occurs the arrival time of the next order is generated.

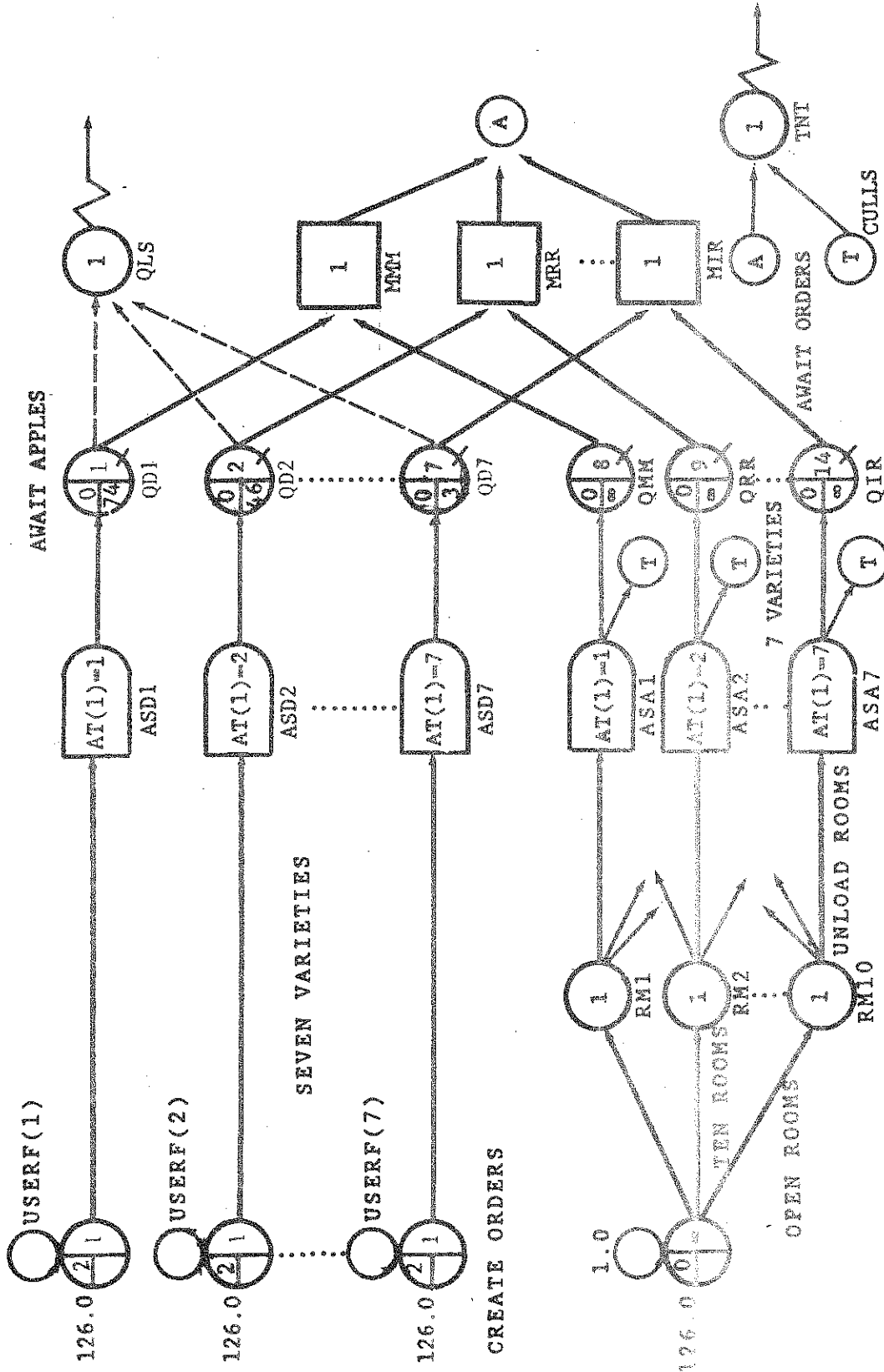

FIGURE 3.2.2. SLAM II FLOW CHART OF THE SIMULATION MODEL.

TABLE 3.2.1. 1985 CONTROLLED ATMOSPHERE ROOM CAPACITIES, ROOM ALLOCATIONS, AND OPENING DATES FOR THE CASE PLANT.

VARIETY	ALLOCATION (BINS)									
	CONTROLLED ATMOSPHERE ROOM NUMBER									
	1	2	3	4	5	6	7	8	9	10
McIntosh	134	0	0	450	408	0	0	0	0	582
Red Romes	0	32	92	0	0	77	279	379	492	0
Red Delic.	0	213	250	0	0	165	263	187	140	0
Empires	11	60	178	0	69	5	83	48	0	46
Gold Delic.	0	51	15	0	0	48	42	36	36	0
Spartans	34	84	0	0	0	0	16	0	0	80
Ida Reds	0	0	0	0	0	0	24	71	45	0
CASE PLANT	179	440	535	450	477	295	707	721	713	708
OTHER	48	52	0	84	32	211	40	26	26	37
TOTAL	227	492	535	534	509	506	747	747	739	745
CAPACITY	238	495	540	540	510	510	750	750	750	750
OPENING DATE	4/12	1/11	3/25	2/20	5/8	3/7	2/13	4/15	5/15	1/15

Orders are generated from two density functions in the model. The first represents interorder times (days/order); the second represents order size (bins/order). Random variables are drawn from each distribution and the interorder time random variable is divided by the order size random variable to get the interarrival time of bin demands (days/bin). After an order is generated, it is placed in a variety specific queue until apples become available to fill the order. The orders wait seven days. If no supplies become available within that seven days, the order becomes a lost sale. If a supply does become available within seven days after the order arrived, then a sale occurs. The value of the sale or lost sale is determined by a random variable drawn from a variety specific price distribution.

By drawing two random variables, interorder time and order size, and transforming them into an interarrival time for bin demand, one implicitly assumes that orders can be partially filled. For example, an order arriving at the case plant might be for 100 boxes of McIntosh. In the model, the boxes are converted to bins and the order is filled one bin at a time. Therefore, if supplies are very low only part of the order may be filled and the remaining portion of the order may become a lost sale. In this way, the construction of the model assumes that the customer will accept partial fulfillment of his or her order.

When the CA rooms are opened, the apples allocated to those rooms are packed. During the simulated packing activity, a variety specific percentage of the apples is graded out or culled. The balance is placed in a variety specific queue to await orders. A sale occurs when an order arrives. The value of the sale is determined by a random variable drawn from a variety specific price distribution and a discount factor that depends upon the difference between the time the apples become available and the time the apples are sold. There is presumed to be no discount for seven days and 0.5% for each day after seven days (the discount is described in detail in section 3.2.4.). The sale of one bin generates revenue equal to the price less the discount times the price, and a lost premium equal to the discount times the price.

3.2.3. Storage Allocation Policies. In the preceding section, the assumptions, parameters, and constraints of the model were discussed. In this section, the variables of the analysis are described.

The apple packing plant has three policies which control the use of its CA storage facilities. First, the firm has a priority policy (P) that establishes the priority of the different varieties with respect to the capacity of a single CA room. Second, the firm has an opening policy (O) which establishes when the CA rooms are opened. Third, the firm has a distribution policy (D) which establishes how the varieties are distributed among the different CA rooms.

The priority policy is used to establish the order in which varieties are allocated the capacity of a storage facility. The firm attempts to maintain a roughly equal quantity of each variety in each room in order to maximize their flexibility in meeting unexpected orders. For example, if a total of 1000 bins of Empires needs to be allocated to four CA rooms, the firm attempts to store 250 bins in each room. This policy is complicated by the varying capacities of the different rooms and by the multiple varieties allocated to each room. Currently, the case firm follows a priority policy that is based more on the order in which the varieties are harvested, i.e., the rooms are filled as evenly as possible on a first-come, first served basis.

Two alternative priority policies are considered. First, the varieties are ranked based upon spectral analysis. Spectral analysis is a method of establishing the importance of several system parameters simultaneously. This method is described in detail in section 3.5. Second, the priority of the varieties is based on the total expected revenue generated by each variety.

The opening policy is used to determine when a CA room is opened. The current policy is not well defined but is based on such things as the size of recent orders, the status of the other CA rooms, and the importance of the customer making the most recent order. In order to place reasonable bounds on the analysis, the customers are assumed to be of equal importance and the sequence in which the rooms are opened is assumed to be fixed.

Two alternative opening policies are considered. First, rooms are opened only when the supply of the top revenue generating variety is exhausted in the preceding room of the same type. In soft rooms, the top revenue generating variety is McIntosh; in hard rooms, the top revenue generating variety is Red Romes. Therefore, under this alternative, hard rooms are opened when the supply of Red Romes is exhausted and soft rooms are opened when the supply of McIntosh is exhausted. Under the second alternative, rooms are opened when the preceding room of the same type is empty. Therefore, a hard room is not opened until the preceding hard room is empty, and a soft room is not opened until the preceding soft room is empty.

The distribution policy is used to determine which varieties are stored in which rooms. It is assumed that rooms designated as hard or soft by the firm can not be changed. Therefore, the only varieties which could have their distributions changed are the SH varieties: Empires and Spartans.

Two alternative distribution policies are considered. First, the SH varieties are allocated to all CA rooms; both hard and soft. This policy is currently used by the firm and is meant to allow a maximum of flexibility in meeting orders for the SH varieties. Second, the SH varieties are only stored in hard rooms. This alternative recognizes the somewhat unique characteristics of McIntosh, the only exclusively soft variety stored by the firm. The state of New York regulates practices surrounding the CA storage of McIntosh. For example, a CA room containing McIntosh must be sealed within ten days after the first McIntosh apples stored in the room are harvested. Also, a room containing McIntosh must be brought to CA conditions (5% oxygen atmosphere) within twenty days after it has been sealed. The second alternative distribution policy is considered as a means of increasing the flexibility of the firm in meeting these regulations by only allocating the SH varieties to the hard rooms.

To summarize, the policy alternatives considered in this analysis are as follows:

S.T.A. Priority established by spectral analysis (S); opening dates established by supply of top revenue generating varieties (T); distribution of SH varieties to all CA rooms (A).

S.T.H. Priority established by spectral analysis (S); opening dates established by supply of top revenue generating varieties (T); distribution of SH varieties to hard rooms (H).

S.P.A. Priority established by spectral analysis (S); opening dates established by supply of all varieties in preceding room (P); distribution of SH varieties to all CA rooms (A).

S.P.H. Priority established by spectral analysis (S); opening dates established by supply of all varieties in preceding room (P); distribution of SH varieties to hard rooms (H).

R.T.A. Priority established by expected revenue (R); opening dates established by supply of top revenue generating varieties (T); distribution of SH varieties to all CA rooms (A).

R.T.H. Priority established by expected revenue (R); opening dates established by supply of top revenue generating varieties (T); distribution of SH varieties to hard rooms (H).

R.P.A. Priority established by expected revenue (R); opening dates established by supply of all varieties in preceding room (P); distribution of SH varieties to all CA rooms (A).

R.P.H. Priority established by expected revenue (R); opening dates established by supply of all varieties in preceding room (P); distribution of SH varieties to hard rooms (H).

In this section the alternative policy options were described. In the next section, the performance measures used to compare these policies are presented.

3.2.4. Performance Measurement. The storage allocation policies are ranked based upon their contributions to lost sales (LS) and to lost premiums (LP). Lost sales and lost premiums are used instead of other measures, e.g. total revenue, because LP indicates the direct cost of a policy and LS indicates the indirect cost of a policy. Defining performance based upon these measures yields more information than defining performance based only upon total revenue; yet yields the same result, i.e., realizing potential revenue by reducing lost premiums and lost sales.

Decreasing LP increases revenue directly by helping the firm realize revenue lost to discounts. Large inventories can depress prices on an industry wide scale [Tomek and Robinson, p.280]. A similar phenomenon occurs in the firm. If the firm is maintaining a large inventory of a particular product, the firm is likely to be soft in price negotiations. This inclination to discount is particularly likely if the product is perishable or semi-perishable. By suppressing these discounts, the firm can increase revenue. The discounts are suppressed by reducing inventories in periods of lost premiums (discounts) and increasing inventories in periods of lost sales.

LS indicates the indirect cost of a policy alternative. Costs associated with LS are not direct costs that appear in the financial statements but are composed of a variety of indirect factors. Principally, LS is composed of intangible goodwill costs, e.g., the lost profit from the sales of other apple varieties, or from the sale of the same apple variety, resulting from an unsatisfied customer taking his or her business elsewhere and urging other customers to take their business elsewhere [Hadley and Whitin, p.20]. In the model, the revenue lost from a sale was used to estimate the combined value of all the components of a lost sale.

A lost sale, a lost premium, or neither is generated in each time period. When orders and supplies are the same in any period, revenue is generated without a lost premium or a lost sale. When supplies exceed orders, a lost premium is generated, without a lost sale. When orders exceed supplies, a lost sale is generated without a lost premium.

A lost sale (LS) occurs when, in a given period, the demand for apples exceeds the availability of apples. The value of a lost sale is equal to the price of apples during the period times the quantity of sales lost. The demand for apples, for the purpose of calculating LS, was defined as the orders awaiting supplies for seven days ($K=7$). It was assumed that customers would wait seven days without cancelling their orders and that orders were filled on a first-in, first-out (FIFO) basis.

The value of lost sales in period t can be expressed:

$$LS_t = \sum_{i=1}^I P_{it} (q_{i,t-K}^d - (Q_{i,t-k}^s + q_{i,t-k}^s + \dots + q_{it}^s))^+$$

where P_{it} is the price of variety i in period t ; $q_{i,t-k}^d$ is the quantity of variety i ordered in period $t-k$; Q_{it}^s is the quantity of variety i available at the beginning of period t ; q_{it}^s is the quantity of variety i made available in period t ; and I is the total number of varieties stored in CA storage by the firm.

A lost premium (LP) occurs when, in a given period, the availability of apples exceeds the demand for apples. The value of the lost premium equals the discounted price during the period times the quantity available in excess of orders. The discount factor is a function of the difference between the time the apples are sold and the time they became available.

The exact form of the discount is unknown. It was assumed that there would be no discount associated with apples left unsold seven days or less. Apples unsold after seven days were discounted $\frac{1}{2}\%$ per day, so:

$$d(\varphi) = \begin{cases} 0 & \text{for } \varphi \leq 7 \\ .005(\varphi-7) & \text{for } \varphi > 7 \end{cases}$$

where φ is the difference between the time the apples were sold and the time the apples became available, in days.

Lost premium in period t is the product of $d(\varphi)$ and the quantity of apples sold in period t that were discounted by $d(\varphi)$:

$$LP_t = \sum_{i=1}^I \sum_{\varphi=1}^{\infty} P_{it\varphi} d(\varphi) P_{it\varphi} Q_{it}^d$$

where:

$$P_{it\varphi} = \frac{(q_{i,t-\varphi}^s - (Q_{i,t-\varphi}^d + q_{i,t-\varphi-1}^d + \dots + q_{it}^d))^+}{Q_{it}^s}$$

The total quantity of outstanding orders for variety i at the beginning of period t is Q_{it}^d , i.e. the sum of unfilled orders. The proportion of Q_{it}^d that was filled with supplies that have been waiting φ days is $P_{it\varphi}$. The value of the discount in period t associated with selling apples that have been waiting φ days is the product of the proportion of apples sold that had waited φ days, the discount factor associated with φ days, the price during the period, and the quantity sold. The value of the discount is then summed for each variety ($i = 1, 2, \dots, I$) and each discount period ($\varphi = 1, 2, \dots$).

In this section, the measures of performance used to evaluate the alternative storage allocation policies were described in detail. In the next section, the data sources used to develop and validate the model are presented.

3.3 DATA SOURCES AND MODEL VALIDATION

In section 3.2 a description of the model's general structure was presented. In this section the sources of the data used to calibrate the model are described and the performance of the model relative to the case plant is presented.

3.3.1. Data Sources. The model was constructed using data from the case plant described in section 2.4. Invoices for sales occurring between January 1 and July 31, 1982 through 1986, were collected and examined. Each invoice represents one sale. Variety, date, grade, order size, price, and pack type were recorded from each invoice. Unfortunately, the set of invoices for 1985 is incomplete.

The data were sorted by variety, date, order size, and price. Empirical density functions representing interorder times, price, and order size were derived from the sorted data [Law and Kelton, p.176]. The price data were adjusted to reflect annual changes in the central tendency of the prices. The prices of all grades of an agricultural product tend to move up and down together, implying that while the central tendency of a price distribution might move, the dispersion of prices probably stays the same [Tomek and Robinson, p.140]. The dispersion of the prices represents the dispersion of grades available to the firm, and the cost of lost premiums, but the mean price reflects many factors not included in the model. Some of the price distributions exhibit bimodality, implying that the firm produces two distinct grades of that apple variety. In order to make each year's price data comparable to 1985, all prices were adjusted so that the annual mean price is equal to the 1985 mean price. This procedure is imperfect of course, because prices evolve continuously but were adjusted discretely.

Empirical density functions were derived for interorder time (days/order), price (1985 \$/bin), and order size (bins/order) for each variety except Spartans. Density functions for Spartans are not derived because of the exiguous number of observations. Instead, expected values for interorder time, price, and order size are used for Spartans. The hypothesized density functions were derived using one half of the data from the four years of sales observations. These hypothesized functions were then checked using the Chi-squared goodness-of-fit test on the half of the data not used to hypothesize the distributions. Using half the data to hypothesize the density functions and half of the data to test the fit increases the degrees of freedom associated with the test [Law and Kelton, p. 194] (Table 3.3.1). The test indicates that, in all cases, the null hypothesis (H_0 : the parameter is distributed as hypothesized) could not be rejected at the 10% level of significance. One can conclude, therefore, that

the hypothesized functions accurately represent the distributions of interorder time, price, and order size.

In hypothesizing the density functions, the observations were sorted into cells. For interorder times, the observations are discrete non-negative integers (0,1,...) and so the derived probabilities correspond to discrete values. However, price and order size observations appear to be continuous, so the derived probabilities correspond to a range of values. The cell boundaries for the continuous variables were chosen so that the expected number of values in each cell is greater than or equal to five and so that the total number of cells is less than thirty [Law and Kelton, p.197].

To simulate the continuous nature of the price and order size distributions, the sampling algorithm includes a procedure for interpolating between cell boundaries [Law and Kelton, p.262]. First, a cell is randomly chosen with a probability given by the empirical density functions. Then a uniform distribution with a minimum value equal to the lower cell boundary and a maximum value equal to the upper cell boundary is used to generate a random variable within the cell. An example of a derived cumulative distribution of order sizes is presented in Figure 3.3.1.

Two important quantities can not be inferred from the data: unfilled orders and discounts. Since invoices were used to define the order rate parameter, the true demand or true order rate for the apples is unknown. The data indicated only the orders that were filled, not those that were unfilled. This limitation introduces bias into the analysis, since demand would appear to be high when apples are available, and non-existent when apples are not available. Data from all four years were used to hypothesize the interorder time distributions in order to partially correct for this bias. Each year the firm has a different allocation and opening date policy, so apples are available at different times during different years. Demand not appearing during one period of one year appears during the same period of another year. By using several years of data a partially corrected demand rate distribution was derived.

Also discounts can not be derived from the price data. Apples that have deteriorated are sold at a discount. The exact size of this discount and the exact effect of time on quality are unknown. However, an approximation of this effect was presumed. A discount function based on the difference between the time the apples are removed from CA storage and the time they are sold is included in the model. The discounts generated can be thought of as an estimate of the additional revenue that can be earned if the apples are sold immediately after being removed from CA storage. The discount is discussed in section 3.2.4.

TABLE 3.3.1. RESULTS OF THE GOODNESS-OF-FIT TEST ON THE EMPIRICAL DENSITY FUNCTIONS USED IN THE SIMULATION MODEL.

VARIETY	RANDOM VARIABLE	DF	CALCULATED CHI-SQUARED	CRITICAL CHI-SQUARED
Macintosh	IOT	6	6.28	10.65
	Bins/Order	8	8.04	13.36
	\$/Bin	10	13.12	15.99
Red Romes	IOT	6	4.67	10.65
	Bins/Order	7	9.33	12.02
	\$/Bin	10	4.60	15.99
Red Delic	IOT	4	6.62	7.78
	Bins/Order	9	13.66	14.68
	\$/Bin	9	5.19	14.68
Empires	IOT	8	12.19	13.36
	Bins/Order	9	13.41	14.68
	\$/Bin	10	6.32	15.99
Gold Delic	IOT	4	3.48	7.78
	Bins/Order	3	5.75	6.25
	\$/Bin	4	1.62	7.78
Ida Reds	IOT	7	9.64	12.02
	Bins/Order	7	5.30	12.02
	\$/Bin	4	1.59	7.78

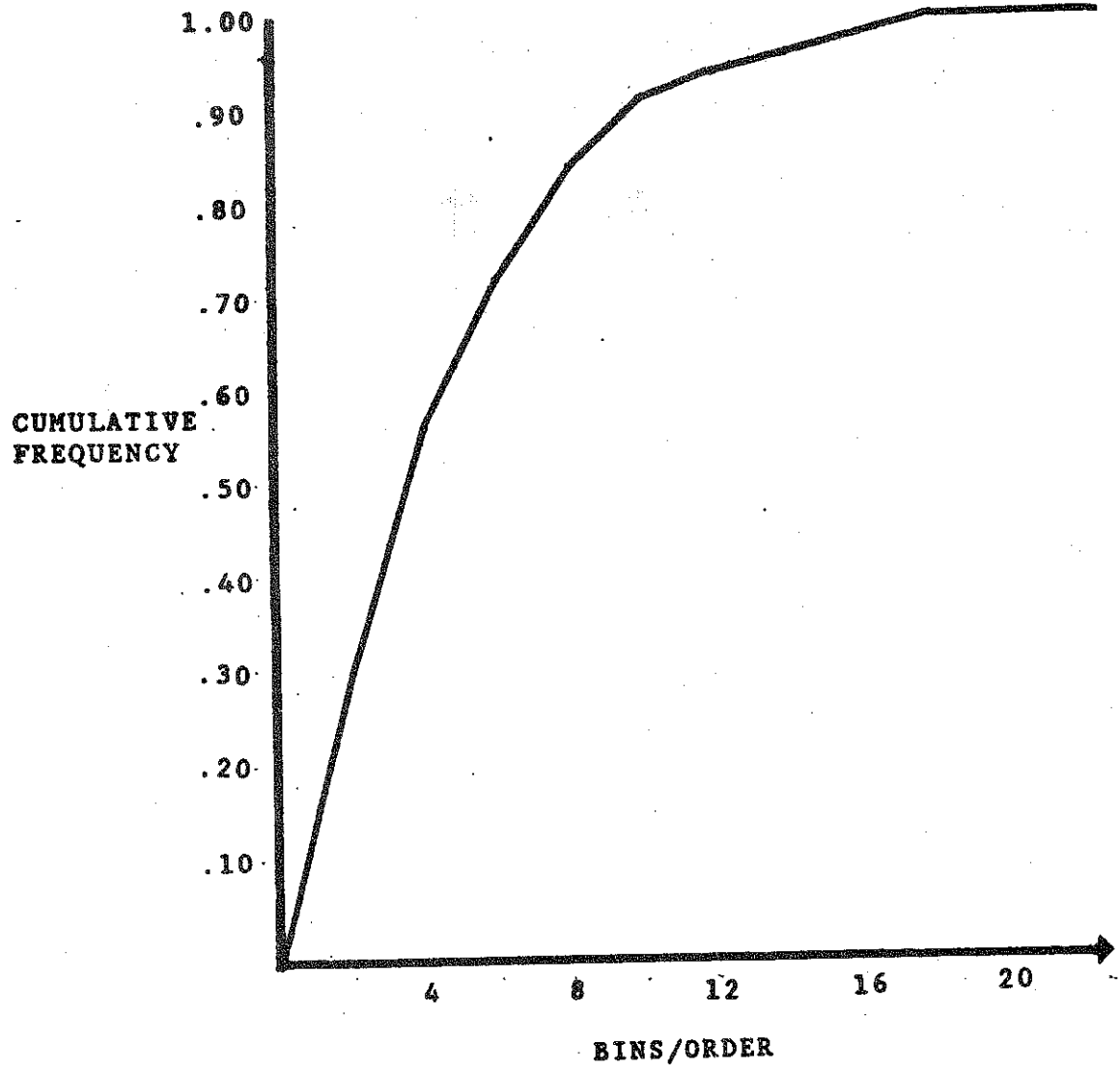

FIGURE 3.3.1. EMPIRICAL CUMULATIVE DISTRIBUTION FUNCTION USED IN THE SIMULATION MODEL FOR MCINTOSH ORDER SIZE.

3.3.2. Model Validation. The model was validated using the revenue generated by each variety. The revenue generated in the simulation by each variety is compared with the expected revenue generated by the firm in 1985.

The expected revenue generated by the firm in 1985 is used for two reasons. First, the data on total revenue earned during the period between January and July 1985 contain revenue from the sale of non-CA room apple. The firm sold some quantity of apples from refrigerated storage during the early part of this period. As a result the actual quantity sold of McIntosh, Red Romes, Red Delicious, and Empires exceeds the quantity stored. Second, some invoices of the sales of Golden Delicious, Spartans, and Ida Reds are missing. As a result, the cumulative sales of these three varieties during 1985 is less than the quantity stored. The missing invoices have little effect on the results of the analysis since the expected revenue from these three varieties account for less than 10% of the total revenue. The expected revenue generated by each variety in 1985 is presented in Table 3.3.2.

The allocation of CA storage used by the firm and the dates the CA rooms were opened in 1985 are used to compare the performance of the firm with the performance of the model. The model is run seven times and the average revenue of the seven runs was compared with the expected revenue generated by each variety in 1985. The results are summarized in Table 3.3.3.

The number of replications needed to establish a given confidence interval for the results is derived in the following manner. First, a "small" number of runs is made. Second, a test is performed to determine whether the expected values of certain critical parameters fall within a given confidence interval [Pritsker, p.55]. Third, if the test fails, then an additional run is made. The steps are repeated until the expected values fall within the confidence intervals. For this research seven runs were found to be sufficient to ensure that total revenue falls within a ninety per cent confidence interval with a halfwidth equal to five per cent of the 1985 expected revenue. Therefore, in order to derive estimates of the performance of the system seven runs were made for each experiment.

The results of the seven replications of the model are presented in Table 3.3.3. They indicate that the model is an extremely good fit. The maximum percentage difference between the model generated revenue and the firm's actual revenue for each variety is 6.3%. Total model generated revenue varied less than two percent from the 1985 total revenue.

3.4. EXPERIMENTAL DESIGN

The simulation model described in section 3.2 was used to meet the objectives described in section 1.2. The first objective of the research is to identify the best storage allocation policy for a range of demand patterns. The alternative storage allocation policies are described in detail in section 3.2.3. In the previous section it was shown that seven replications of the model generated highly favorable confidence intervals, so the model was replicated seven times under each policy alternative.

A 2^3 factorial experiment is performed and an analysis of the variance (ANOVA) in lost premium and in lost sales is used to identify the source of the variation in performance as priority policy, opening policy, or distribution policy [Snedecor and Cochran, pp. 359-61]. From the ANOVA results, the null hypothesis that the mean performance is not changed due to differences in these policies is tested.

TABLE 3.3.2. EXPECTED REVENUE FROM APPLES STORED IN CONTROLLED ATMOSPHERE STORAGE FACILITIES DURING THE 1984-85 SEASON.

VARIETY	QUANTITY STORED (Bins)	EXPECTED CULLS (Bins)	NET SOLD (Bins)	AVERAGE PRICE (\$/Bin)	EXPECTED REVENUE (\$000)
McIntosh	1574	258 (16%)	1316	208.58 (2)	274.49
Red Romes	1351	78 (6%)	1273	179.27 (4)	228.21
Red Delic.	1218	181 (15%)	1037	171.69 (5)	178.04
Empires	500	56 (11%)	444	236.17 (1)	104.86
Gold. Delic.	228	40 (18%)	188	204.39 (3)	38.43
Spartans	214	58 (27%)	156	164.57 (6)	25.67
Ida Reds	140	46 (33%)	94	150.99 (7)	14.19

TABLE 3.3.3. COMPARISON OF REVENUE EXPECTATIONS OF SEVEN
SIMULATION RUNS WITH 1985 CASE PLANT REVENUE.

RUN	REVENUE (\$000)							
	MM	RR	RD	VARIETY		SP	IR	TOTAL
				EE	GD			
1	263.45	245.05	186.17	101.45	38.96	26.99	14.52	876.47
2	260.43	234.77	185.95	103.08	38.01	26.66	14.23	863.00
3	269.67	242.09	182.57	102.11	39.07	25.84	14.82	876.04
4	270.97	232.87	185.36	103.76	40.12	26.17	13.27	872.39
5	262.80	248.07	191.15	99.54	39.69	26.00	14.42	881.55
6	262.66	253.01	190.04	101.37	41.57	26.33	16.37	891.21
7	265.41	242.15	193.20	100.27	39.56	26.33	15.05	881.84

$\bar{\mu}$	265.06	242.57	187.78	101.65	39.57	26.33	14.67	877.50
$\hat{\sigma}$	3.90	7.08	3.76	1.48	1.11	0.39	0.94	8.78
$\hat{\delta}$	1.5%	2.9%	2.0%	1.5%	2.8%	1.5%	6.4%	1.0%

'85	274.49	228.21	178.04	104.86	38.43	25.67	14.19	863.89
%dif	-3.4%	6.3%	5.5%	-3.1%	3.0%	2.6%	3.4%	1.6%

In order to show that the results are not specific to the linear discount function that is used in the model, the analysis is repeated under an alternative exponential discount function:

$$d(\varphi) = \begin{cases} 0 & \text{for } \varphi \leq 7 \\ (\varphi-7)^2/2000 & \text{for } \varphi > 7 \end{cases}$$

Each policy is replicated seven times under the above discount function. An analysis of the variance in the two performance measures is performed in order to identify differences between the results under a linear discount function and under an exponential discount function.

The policies are re-evaluated under two alternative levels of order rate fluctuations. The expected order rate for all varieties is assumed to increase gradually, beginning February 1 and reach a maximum on approximately April 1. After April 1, the expected order rates decrease, reaching the original level by June 1. An example of this pattern is presented in Figure 3.4.1. Two maximum levels are considered. First a maximum of 112.5% of the original expected order rate is considered. Second, a maximum expected order rate of 125% of the original is considered.

These fluctuations in order rate are examined in order to identify any differences in the best policy resulting from changes in the expected order rate. The firm is likely to experience some peak in order rate due to the supplies of regular storage apples early in the marketing period and the supply of early ripening varieties late in the marketing period.

The second objective of the research is to identify the best number of CA rooms for the demand pattern considered. This objective is met by performing sensitivity analysis on the model with additional CA rooms. The firm maintained three idle CA rooms during the 1984-85 season. Rooms A, B, and C have a capacity of 436, 495, and 1050 bins, respectively. In order to determine whether these additional CA rooms should be utilized and whether the additional rooms should be designated "hard" or "soft", seven alternatives are considered. In each experiment the "best" storage policy (identified in the preceding policy analysis) is used in the model. The alternatives were as follows:

- H. Add one hard room.
- S. Add one soft room.
- HS. Add one hard and one soft room.
- HH. Add two hard rooms.
- SS. Add two soft rooms.
- HHS. Add one soft room and two hard rooms.
- SSH. Add one hard room and two soft rooms.

A student's t-test [Snedecor and Cochran, pp.100-2] is used to determine whether differences between the performance of the system under alternative capacity options are significant.

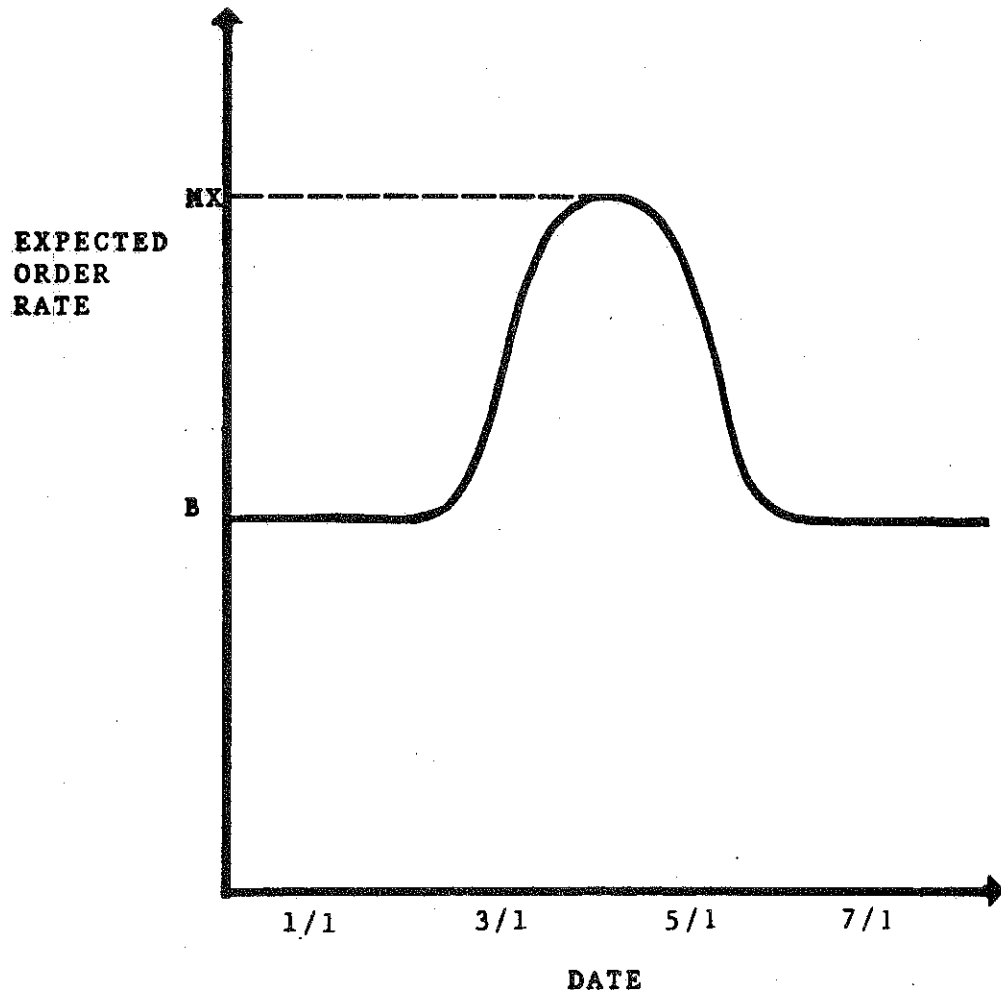

**FIGURE 3.4.1. EXPECTED ORDER RATE UNDER
NON-STATIONARY DEMAND.**

The third objective is to identify the best input quantities (orchard composition) for a range of storage capacities and demand patterns. This objective is met by performing a sensitivity analysis on the model with alternative orchard compositions.

All of the varieties grown by the firm have an excess of expected orders, i.e., expected orders exceed expected supplies. The exact amount of expected excess orders is presented in Table 3.4.1. Experiments are performed to determine the effect of changing the orchard composition by reducing the number of varieties grown and utilizing the excess orders.

Golden Delicious, Spartans, and Ida Reds each account for less than 5% of total expected revenue and collectively account for less than 10% of total expected revenue. Therefore, orchard compositions in which the resources associated with the production of these three varieties are reallocated to the other four are considered. The three alternatives are to reallocate all production resources associated with Golden Delicious, Spartans, and Ida Reds to the production of the following:

M. McIntosh only.

MH. Half McIntosh and half hard varieties (Romes, Red Delicious, and Empires).

H. Hard varieties only.

Resources are only allocated to the different varieties to the extent to which orders are expected for these varieties. Each alternative was replicated seven times and the results are compared using a student's t-test [Snedecor and Cochran, p.100-2].

In this section the methodology used to meet the objectives of the research is presented. In the next section, the use of spectral analysis for ranking the different varieties with respect to lost premium and lost sales is described.

3.5 SPECTRAL ANALYSIS

Spectral analysis is a method of estimating the relative contribution of a system's parameters to the variance of a system's output. In the usual time series application, spectral analysis estimates the contribution of "hidden periodicities" to the variance of a series of observations over time [Chatfield, p.127].

The objective of sensitivity analysis is to measure the sensitivity of a system to changes in system parameters. Traditionally, sensitivity analysis of simulations has been run-based and therefore extremely expensive in terms of computer time. However, methodologies for using spectral analysis to measure the relative importance of a system's parameters to a system's output have recently been developed (e.g. Schruben and Cogliano, 1981; Cogliano, 1982).

TABLE 3.4.1. EXPECTED EXCESS ORDERS FOR EACH VARIETY.

VARIETY	EXPECTED QUANTITY ORDERED	QUANTITY STORED (all quantities are in bins)	EXPECTED CULLS	EXPECTED QUANTITY SUPPLIED	EXPECTED EXCESS ORDERS
McIntosh	2100	1574	258	1316	784
Red Romes	1314	1351	78	1273	41
Red Delic	1376	1218	181	1037	339
Empires	546	500	56	444	102
Gold Delic	516	228	40	188	28
Spartans	250	214	58	156	94
Ida Reds	198	140	46	94	104

Spectral analysis is based on the Wiener-Khintchine theorem that for any stationary stochastic process with autocovariance function $\gamma(k)$, there exists a monotonically increasing function $F(\omega)$, such that:

$$\gamma(k) = \int_0^{\pi} \cos \omega k \, dF(\omega) \quad (3.4.1)$$

where ω is the angular frequency (radians per unit time) and is related to the wavelength ($1/f$) by $1/f = 2\pi/\omega$. Equation (3.4.1) is known as the spectral representation of the autocovariance function and implies that every frequency between 0 and π may contribute to the variance of a process. From Equation (3.4.1), the variance of the process can be expressed:

$$\gamma(0) = \sigma^2 = \int_0^{\pi} dF(\omega) \quad (3.4.2)$$

The relative significance of a range of frequencies (0 to ω) to the variance of a process can be expressed [Chatfield]:

$$F^*(\omega) = F(\omega)/\sigma^2 \quad (3.4.3)$$

In the context of a simulation model, parameters can be oscillated at established frequencies and, from the estimate of the response spectrum, the relative contribution of each of the parameters can be established.

Spectral analysis possesses several advantages over the traditional run-based sensitivity approach. In a run-based simulation, the effect of each parameter on the performance of the system is examined by making discrete changes in parameter values and re-running the entire simulation. This process is expensive, in terms of computer time, and time consuming, in terms of real time. With spectral analysis several parameters can be examined in the same run; eliminating the need for performing a separate computer run for each parameter. Another advantage of spectral analysis is that interactions between parameters can be identified.

Spectral analysis also has some disadvantages. First, the calculations for estimating the spectrum are complex. Second, the number of observations required to attain a valid spectral estimate can be very large. Third, conclusions drawn from the spectral estimates must be critically examined, since the calculated spectrum is only an estimate of the true spectrum.

Spectral analysis of simulation models are frequently discussed in connection with "meta-models". Meta-models are derived, empirical, functional relationships between parameters and variables. By analyzing the estimated spectrum the appropriate functional form for a meta-model can be derived.

Schruben and Cogliano (1985) presented a step-by-step method for spectral analysis of simulations:

1. Select a range of interest (amplitude) for each input factor (the larger the region the more power there is to detect input factor effects).

2. Select driving frequencies for input factors, and identify indicator frequencies (b =minimum band width).
3. Choose a window size (m) and run length (n) such that $m > 4 / 3b$ and $20m > n > 3m$ (Tukey Window) [Chatfield, p.141].
4. Run $p+1$ independently seeded replications of the simulation. Input factors oscillate according to:

$$x(t) = .5(U+L) + .5(U-L)\cos 2 \omega t$$

where: U is the upper value of the input factor and L is the lower value of the input factor

5. Compute the sample spectrum for the response series.

$$f_{ij}(\omega) = \left\{ \lambda_0 C_0 + \sum_{k=1}^m \lambda_k C_k \cos \omega k \right\} / \pi \quad 0 \leq \omega \leq .5$$

$$C_k = 1/n \sum_{t=1}^{n-k} (y_t - Y)(y_{t+k} - Y) \quad 0 \leq k \leq n-1$$

$$C_{-k} = C_k$$

where i is the term number; j is the run number; Y is the expected value of y_t ; and λ_k is the Tukey Window [Chatfield, p.141]:

$$\lambda_k = 1/2 (1 + (\pi k/m))$$

with degrees of freedom: $\nu = 8n/3m$

6. Compute the spectral ratio for term i oscillated at ω :

$$F_i(\omega) = \frac{\frac{1}{\nu r} \sum_{j=1}^r f_{ij}(\omega)}{\frac{1}{\nu r} \sum_{j=1}^s f_{cj}(\omega)}$$

where $f_{cj}(\omega)$ is the sample spectrum of the response at frequency ω when no term is oscillated at ω ; νr and νs are the number of runs in which term i is oscillated and no term (c) is oscillated at frequency ω , respectively.

7. Compute the significance of each term in each independent run:
 $P_i(\omega) = \text{prob} \{x > F_i(\omega)\}$ if x is distributed F with νr and νs degrees of freedom (derived from Tukey window calculation).
8. Compute the combined significance level [Rosenthal, 1978]:

$$P_i^* = \text{prob} \left\{ x \geq -2 \sum_{\omega \in \Omega} \ln P_i(\omega) \right\}$$

where Ω is the set of frequencies at which term i was oscillated and x is distributed chi-squared with $2|\Omega|$ degrees of freedom.

Step one involved choosing the range over which the parameters were oscillated (the amplitude). The parameters oscillated are demand rates that are composed of two random variables: interorder times and order sizes. The mean of the interorder time distributions for each variety is oscillated in order to induce oscillations in the order rate. The amplitude chosen is one half of the range, i.e., one half of the difference between the highest and lowest boundaries of the interorder time distributions. Since expected values are used for Spartans, the range is zero. An amplitude of one fourth of the mean was chosen for Spartans. There is no rule for choosing amplitudes except that the amplitude should fill the experimental region [Schruben and Cogliano, (1985), p.22].

Step two requires the choice of driving frequencies that maximizes the minimum bandwidth between frequencies indicating the significance of terms affecting the response. In this analysis, only the direct and interaction effects of demand rate parameters are considered. The direct effect of a parameter oscillated at ω is indicated by the sample spectrum at ω . The interaction effect of two parameters, one oscillated at ω_1 and the other at ω_2 , is indicated by the sample spectrum at $\omega_1 + \omega_2$ and $\omega_1 - \omega_2$. These effects are further complicated by confounding; the natural tendency for responses oscillating at frequencies in the range 0.5π and π to appear to be oscillating at frequencies in the range 0 to 0.5π . These factors were considered in choosing the near optimal driving frequencies used in the analysis. A method developed by Jacobson and Schruben (1986) was used to derive the following eight driving frequencies for the seven parameters (demand rates) and one control:

$$\Omega = \{.0051, .0153, .0408, .0918, .1531, .2194, .3418, .4592\}$$

These driving frequencies result in a minimum bandwidth (b) of $.0051\pi$ when direct and interaction terms are considered.

Step three involves choosing a window size and run length. The window size and run length depend upon the window type chosen. There are several types available, such as Parzen, Daniell, Tukey, and Bartlett [Priestley, p.573]. The Tukey window is used here because of the relative ease of its computation and the relatively high degrees of freedom associated with it.

In step four, $p+1$ independently seeded runs are made in order to account for gain. Gain is the system oscillations that are naturally occurring. The basis of frequency domain sensitivity is induced oscillation. The results of the induced oscillation may be misinterpreted if the natural oscillation, gain, is not corrected for. To correct for gain, a latin square experimental design is used with a control frequency. By using the ratio of the sample spectrum to the control spectrum, a corrected estimate of the spectral ratio is derived.

Step five is the actual calculation of the spectral estimate. Just as there are several alternative windows, there are several alternative estimation procedures, e.g. Hanning, Hamming, Bloomfield [Chatfield, p.142-3]. In step five, the method suggested by Chatfield (p.139) is used.

Steps six through eight involve the calculation of test statistics and the test of hypotheses. In step six, the F statistic relating the estimated spectrum of each term at each frequency to the control spectrum at each frequency is calculated. The significance of the term at each frequency is tested in step seven and the combined significance of each term at all frequencies is calculated and tested in step eight.

The method suggested by Schruben and Cogliano is designed for continuous input factors in a steady-state simulation. A steady-state simulation represents a system that continues indefinitely. The typical agricultural system does not continue indefinitely, but rather exhibits a definite seasonal pattern. Therefore, terminating simulations are typically used to model agricultural systems. Modification of the method presented above for use with terminating simulations requires only that enough runs are made to acquire the needed number of observations, n .

Spectral analysis was performed on the lost premium and lost sales resulting from the validated model. The demand rates for each of the seven varieties were oscillated at seven of the eight frequencies in set W (see above). One frequency was a control. Eight runs of 1280 observations were performed to generate enough data for the spectral analysis.

The results of the spectral analysis indicate that the importance of each variety relative to lost premium and lost sales is not the same as their relative importance with respect to contributions to total revenue. The algorithm described above was used to derive the p^* values presented in Table 3.5.1. The varieties are ranked on the basis of the probability of insignificance with respect to lost premium (since lost premium draws directly from revenue), and their significance with respect to lost sales was used to break ties. This ranking was used in priority policy S.

Several conclusions can be drawn from the results of the spectral analysis. First, none of the varieties significantly influence lost sales. This phenomenon may be because orders were presumed to wait seven days without becoming lost. This assumption may be erroneous, but there is no evidence to suggest that longer or shorter periods may be more appropriate. Undoubtedly some other parameter besides order arrival rate is more important to lost sales. Second, lost premium in soft rooms is generated principally by McIntosh. This result is not surprising since McIntosh apples generate most of the firm's revenue and is the only exclusively soft variety packed by the firm. Empires and Spartans are also stored in soft rooms but represent a much smaller proportion of revenue. Third, lost premium in hard rooms is generated principally by Red Romes. This result is also not surprising given the importance of Red Romes to the firm's revenue. Red Romes are not as important as McIntosh because several other varieties share the CA rooms in which Red Romes are packed. For example, Red Delicious apples are stored in the same rooms as Red Romes and are also important to the generation of lost premium.

The usefulness of spectral analysis to the comparison of the policies in this research depends upon the comprehensiveness of these results. These probabilities were generated from a very specific set of variables defining the CA control policy. If these results are global, then the ranking derived from the spectral analysis is valid under alternative policies. If the results of the spectral analysis are local, then the estimated spectrum and the derived probabilities will be different under different policies. If this is the case, then establishing the priority of the varieties based upon spectral analysis will yield sub-optimal policies.

In this section, a method for the spectral analysis and the results of the spectral analysis of the simulation model were presented. In the next section, the results of the policy and sensitivity analysis of the simulation model are presented.

TABLE 3.5.1. THE RESULTS OF THE SPECTRAL ANALYSIS.

VARIETY	PROBABILITY THAT VARIETY ORDER RATE IS INSIGNIFICANT WITH RESPECT TO	
	LOST PREMIUM	LOST SALES
Macintosh	.00001	.98810
Red Romes	.03162	1.00000
Red Delicious	.22022	.99890
Empires	.99999	1.00000
Golden Delicious	.94887	.45296
Spartans	.98810	.94887
Ida Reds	.94887	.94887

4. SIMULATION RESULTS

The model described in Section 3 was used to examine the performance of the system under alternative storage policy options, under fluctuating order rates, with additional storage capacity, and under alternative orchard compositions. In addition, an alternative measure of lost premium was used to show that the relative performance of the policies does not change. The results of these experiments are presented and several conclusions are drawn in this chapter.

4.1 THE EFFECT OF ALTERNATIVE STORAGE CONTROL POLICY OPTIONS ON SYSTEM PERFORMANCE

4.1.1 Under the Original Parameter Values. As described in section 3.2.3, eight alternative storage allocation policies are considered. The alternatives control when the CA rooms are opened (the opening policy), how the capacity within a CA room is allocated (the priority policy), and in which CA rooms the different varieties are stored (the distribution policy). Two alternatives for each of these component policies are considered. Under the opening policy alternatives, CA rooms are opened when the supply of the top revenue generating variety in a room is exhausted (T), or when the preceding room of the same type is empty (P). Under the priority policy alternatives, capacity is allocated on the basis of spectral analysis results (S) or on the basis of the total expected revenue generated by a variety (R). Under the distribution policy alternatives, Spartans and Empires are stored in all the CA rooms (A) or in hard rooms only (H).

The simulation model was used to identify differences in system performance, i.e., total lost premium and total lost sales, under each policy. In order to reduce the variability in system performance due to differences in random number stream seeds, common random numbers were used to seed corresponding replicates of the simulation [Law and Kelton, p.350]. The significance of individual policy components (priority, opening, and distribution policies) is identified by analyzing the variance in the system performance [Snedecor and Cochran, p.359].

The mean and standard deviation of total lost premium (LP) and total lost sales (LS) under each policy alternative are presented in Table 4.1.1. Under the policy actually used by the firm in 1985, the estimated total lost premium is \$71,390 with a standard deviation of \$9,310. The estimated total lost sales under the 1985 policy is \$507,070 with a standard deviation of \$33,790. If it had been used in 1985, the best policy (policy R.P.H) would have improved LP by about \$46,000 per year while not significantly increasing LS.

The LP and LS generated under the control policy alternatives are all significantly better than under the 1985 policy. Lost premium is improved but lost sales is unchanged because minor improvements can be made in LP by reducing the time apples await orders but LS can only be improved by reducing order waiting time below seven days. For example, under the linear deterioration function, reducing the waiting time of a significant quantity of apples from ten to nine days reduces a significant proportion of lost premium by one half of one per cent. However, reducing the waiting time of a significant number of orders from ten to nine days yields no significant improvement in LS since any orders that wait over seven days are lost. If the waiting time of a significant number of orders is reduced below seven days, then an improvement in LS is realized. Under the policy alternatives

TABLE 4.1.1. MEAN AND STANDARD DEVIATION OF TOTAL LOST PREMIUM AND TOTAL LOST SALES GENERATED UNDER EACH POLICY ALTERNATIVE.

POLICY	LOST PREMIUM (\$000)		LOST SALES (\$000)	
	MEAN	STD. DEV.	MEAN	STD. DEV.
ORIGINAL	71.31	9.31	507.07	33.79
S.T.A	39.92 (7)	3.73	503.26 (1)	29.60
S.T.H	40.34 (8)	3.75	513.75 (4)	33.22
S.P.A	28.31 (3)	2.93	506.14 (2)	42.83
S.P.H	28.80 (4)	2.10	522.31 (7)	20.71
R.T.A	35.25 (5)	7.10	525.51 (8)	39.49
R.T.H	35.60 (6)	3.85	513.39 (3)	10.46
R.P.A	26.69 (2)	2.34	514.78 (6)	8.50
R.P.H	25.74 (1)	2.75	514.10 (5)	46.14

considered, the average waiting time of all orders may have been improved, but the improvement did not fall below seven days so there was no significant improvement in LS.

An analysis of the variance in total lost premium and total lost sales (Tables 4.1.2 and 4.1.3, respectively) reveals that the opening policy and priority policy have a statistically significant effect on total lost premium and that no policy component significantly affects total lost sales. The results indicate that the null hypothesis (H_0 : mean total lost premium or total lost sales is the same under all policies) can be rejected at the 10% level of significance (critical F value is 2.81) when considering the effects of opening policy or priority policy on total lost premium, but cannot be rejected when considering the effect of any of the policy components on total lost sales.

The results of the analysis of variance in lost premium indicate that an important policy component with respect to lost premium is the opening policy, i.e., the policy governing the opening of the controlled atmosphere storage rooms. The opening policy has, itself, two components: first, the rule governing the opening of sequential rooms, and second, the sequence in which the rooms are opened. The second component was not considered in this analysis.

The firm's current strategy regarding opening dates for the CA rooms is poorly defined. It is based on the number of back orders, size of the current order, importance of the customer, etc. When the opening dates used in 1985 were included in the simulation, the resulting lost premium was significantly higher than the lost premium generated by any of the consistent, well-defined policies considered here (lost sales was not significantly different). The first conclusion is, therefore, that a well-defined, consistent opening policy is better than no consistent policy.

Between the opening policies considered, the second, opening rooms when the preceding room is empty (P), was significantly better than the alternative (T). This was true under all other possible policy components. In addition, this policy could contribute significantly to income, if the conservative, linear measure of lost premium is approximately correct, i.e. is a good representation of the true effect of time on the deterioration of the value of apples. The second conclusion is, therefore, that opening rooms when the preceding room is empty is a better policy, with respect to lost premium, than opening rooms based upon the supply of the top revenue generating varieties.

The other significant policy component was the policy for establishing variety priority with respect to storage capacity. Two alternatives were considered: first, establishing priority based on spectral analysis (S), and second, establishing priority based on expected revenue generated by each variety (R). The analysis of the variance in lost premium and lost sales indicates that the priority policy has a significant effect on lost premium but not on lost sales. Between the two priority policies, basing the priority of varieties within a CA room on expected revenue generated was shown to be superior to ranking based upon spectral analysis. The third conclusion is, therefore, that the firm should rank varieties based upon their expected contribution to total revenue.

TABLE 4.1.2. ANALYSIS OF THE VARIANCE IN TOTAL LOST PREMIUM.

SOURCE	DEGREES OF FREEDOM	SUM OF SQUARES	MEAN SUM OF SQUARES	F
PRIORITY POLICY (P)	1	173.71	173.71	12.735*
OPENING POLICY (O)	1	1512.06	1512.06	110.855*
DISTRIBUTION POLICY (D)	1	.08	.08	.006
P • O	1	19.58	19.58	1.435
P • D	1	2.00	2.00	.147
O • D	1	1.32	1.32	.097
P • O • D	1	1.64	1.64	.120
ERROR	48	654.72	13.64	
TOTAL	55	2365.11		

*Sources which are not insignificant at 10%.

TABLE 4.1.3. ANALYSIS OF THE VARIANCE IN TOTAL LOST SALES.

SOURCE	DEGREES OF FREEDOM	SUM OF SQUARES	MEAN SUM OF SQUARES	F
PRIORITY POLICY (P)	1	441.51	441.51	.435
OPENING POLICY (O)	1	2.14	2.14	.002
DISTRIBUTION POLICY (D)	1	164.64	164.64	.162
P • O	1	408.35	408.35	.403
P • D	1	1352.61	1352.61	1.334
O • D	1	260.76	260.76	.257
P • O • D	1	27.61	27.61	.027
ERROR	48	48669.65	1013.95	
TOTAL	55	51327.25		

*Sources which are not insignificant at 10%.

TABLE 4.1.4. MEAN AND STANDARD DEVIATION OF TOTAL LOST PREMIUM AND TOTAL LOST SALES GENERATED UNDER EACH POLICY ALTERNATIVE AND UNDER AN EXPONENTIAL DISCOUNT FUNCTION.

POLICY	LOST PREMIUM (\$000)		LOST SALES (\$000)	
	MEAN	STD. DEV.	MEAN	STD. DEV.
S.T.A	81.41 (7)	11.54	503.26 (1)	29.60
S.T.H	93.30 (8)	14.97	513.75 (4)	33.22
S.P.A	49.19 (3)	8.59	506.14 (2)	42.83
S.P.H	50.99 (4)	5.55	522.31 (7)	20.71
R.T.A	64.20 (5)	18.90	525.51 (8)	39.49
R.T.H	66.35 (6)	8.86	513.39 (3)	10.46
R.P.A	43.89 (2)	7.24	514.78 (6)	8.50
R.P.H	40.27 (1)	7.03	514.10 (5)	46.14

TABLE 4.1.5. ANALYSIS OF THE VARIANCE IN TOTAL LOST PREMIUM
GENERATED UNDER AN EXPONENTIAL DISCOUNT FUNCTION.

SOURCE	DEGREES OF FREEDOM	SUM OF SQUARES	MEAN SUM OF SQUARES	F
PRIORITY POLICY (P)	1	3168.78	3168.78	25.350*
OPENING POLICY (O)	1	12794.24	12794.24	102.370*
DISTRIBUTION POLICY (D)	1	130.69	130.69	1.046
P • O	1	692.81	692.81	5.543*
P • D	1	201.06	201.06	1.609
O • D	1	220.14	220.14	1.761
P • O • D	1	16.32	16.32	.131
ERROR	48	5999.20	124.98	

TOTAL	55	23223.24		

*Sources which are not insignificant at 10%.

TABLE 4.1.6. ANALYSIS OF THE VARIANCE IN TOTAL LOST SALES
GENERATED UNDER AN EXPONENTIAL DISCOUNT
FUNCTION.

SOURCE	DEGREES OF FREEDOM	SUM OF SQUARES	MEAN SUM OF SQUARES	F
PRIORITY POLICY (P)	1	435.74	435.74	.372
OPENING POLICY (O)	1	1.75	1.75	.001
DISTRIBUTION POLICY (D)	1	168.19	168.19	.144
P • O	1	402.80	402.80	.344
P • D	1	1362.75	1362.75	1.163
O • D	1	256.33	256.33	.219
P • O • D	1	29.07	29.07	.025
ERROR	48	56249.05	1171.86	
TOTAL	55	58905.69		

*Sources which are not insignificant at 10%.

Finally, one can conclude that the distribution policy, i.e., the policy for distributing SH varieties among the CA rooms has no significant effect on lost premium or on lost sales, when the expected order rate is stationary. Furthermore, these conclusions are based upon the system parameters and constraints described in Chapter 3 and apply only to firm's operating within conditions similar to those described.

4.1.2 Under an Alternative Discount Function. To discover the effect of the discount function on the results, the experiments were repeated using an alternative discount function. The original discount function assumed there was no discount for apples less than seven days old and 0.5% discount for each day after seven days. The alternative form assumed that there was no discount for seven days but increased exponentially $(.001(\varphi - 7)^2)$ for each day after seven days ($\varphi > 7$).

The mean and standard deviation of total lost premium and total lost sales under each policy and using the exponential discount function are presented in Table 4.1.4. The ranks of each alternative with respect to total lost premium and total lost sales are identical for the exponential discount function and for the original linear function. An analysis of the variance in total lost premium and total lost sales (Table 4.1.5 and 4.1.6, respectively) indicate that total lost premium is still significantly influenced by the opening and priority policies and not significantly influenced by the distribution policy. With the exponential discount function, the interaction between the two policies also affects total lost premium. Total lost sales is not significantly influenced by any of the policy components with an exponential discount function. A slight change in the discount function was shown to cause no change in the relative results, so a firm facing a slightly different discount function may expect results similar to these.

In this section the results of the policy analysis were presented. In order to show that the results were not specific to the linear representation of the discount function, the experiments were repeated for an exponential representation of the discount function. In the next section, the effect of a fluctuating order rate on system performance is examined.

4.2 THE EFFECT OF NON-STATIONARY EXPECTED ORDER RATE ON SYSTEM PERFORMANCE

In the previous section, the effect of alternative policies on system performance was presented. These results apply to the system described in section 3.2, in which expected order rate for all apple varieties is stationary. In this section, the effects of two levels of non-stationary expected order rates are examined.

Each policy was simulated under two levels of fluctuation in expected order rate. First, the expected order rate was assumed to increase gradually beginning in February, reach a maximum of 112.5% of the stationary expected order rate on April 1, and then decrease to the original level by June 1. Second, the same pattern was followed but the maximum was 125% of the stationary expected order rate. The mean and standard deviation of total lost premium and total lost sales for each policy under a peak expected order rate of 112.5% and 125% of the stationary rate are presented in Table 4.2.1 and Table 4.2.2, respectively. An analysis of the variance in total lost premium and total lost sales was performed in order to identify changes in the significance of policy components resulting from these fluctuations in the expected order rate (Tables 4.2.3 through 4.2.6).

TABLE 4.2.1. TOTAL LOST PREMIUM AND TOTAL LOST SALES GENERATED UNDER A NON-STATIONARY EXPECTED ORDER RATE WITH A MAXIMUM AT 112% OF THE STATIONARY RATE.

POLICY	LOST PREMIUM (\$000)		LOST SALES (\$000)	
	MEAN	STD. DEV.	MEAN3	STD. DEV.
S.T.A	32.43 (7)	4.59	557.47 (1)	16.90
S.T.H	40.84 (8)	6.27	565.76 (3)	22.62
S.P.A	26.31 (3)	1.33	567.00 (4)	23.04
S.P.H	29.52 (4)	2.65	572.09 (5)	16.35
R.T.A	31.49 (6)	3.64	573.09 (6)	28.48
R.T.H	30.94 (5)	3.53	573.43 (7)	41.39
R.P.A	25.83 (2)	2.33	563.36 (2)	27.62
R.P.H	24.81 (1)	2.61	580.58 (8)	15.58

TABLE 4.2.2. TOTAL LOST PREMIUM AND TOTAL LOST SALES GENERATED UNDER A NON-STATIONARY EXPECTED ORDER RATE WITH A MAXIMUM AT 125% OF THE STATIONARY RATE.

POLICY	LOST PREMIUM (\$000)		LOST SALES (\$000)	
	MEAN	STD. DEV.	MEAN3	STD. DEV.
S.T.A	31.25 (7)	4.30	630.03 (3)	9.10
S.T.H	34.56 (8)	3.44	635.37 (6)	33.67
S.P.A	25.04 (3)	2.12	622.94 (2)	37.89
S.P.H	29.22 (4)	2.30	617.90 (1)	19.54
R.T.A	30.04 (5)	4.00	634.50 (5)	28.09
R.T.H	30.37 (6)	2.28	644.61 (7)	41.42
R.P.A	23.46 (1)	1.44	646.99 (8)	28.67
R.P.H	24.69 (2)	3.10	631.54 (4)	40.41

TABLE 4.2.3. ANALYSIS OF THE VARIANCE IN TOTAL LOST PREMIUM
GENERATED UNDER A NON-STATIONARY EXPECTED ORDER RATE
WITH A MAXIMUM AT 112.5% OF THE STATIONARY RATE.

SOURCE	DEGREES OF FREEDOM	SUM OF SQUARES	MEAN SUM OF SQUARES	F
PRIORITY POLICY (P)	1	224.88	224.88	16.742*
OPENING POLICY (O)	1	747.96	747.96	55.684*
DISTRIBUTION POLICY (D)	1	88.65	88.65	6.600*
P • O	1	27.78	27.78	2.068
P • D	1	152.33	152.33	11.340*
O • D	1	28.12	28.12	2.093
P • O • D	1	19.66	19.66	1.464
ERROR	48	644.75	13.43	
TOTAL	55	1934.13		

*Sources which are not insignificant at 10%.

TABLE 4.2.4. ANALYSIS OF THE VARIANCE IN TOTAL LOST SALES
GENERATED UNDER A NON-STATIONARY EXPECTED ORDER
RATE WITH A MAXIMUM AT 112.5% OF THE STATIONARY RATE.

SOURCE	DEGREES OF FREEDOM	SUM OF SQUARES	MEAN SUM OF SQUARES	F
PRIORITY POLICY (P)	1	692.53	692.53	1.081
OPENING POLICY (O)	1	154.15	154.15	.241
DISTRIBUTION POLICY (D)	1	837.39	837.39	1.307
P • O	1	297.58	297.58	.464
P • D	1	15.26	15.26	.024
O • D	1	164.06	164.06	.256
P • O • D	1	352.86	352.86	.551
ERROR	48	30751.16	640.65	

TOTAL	55	33264.97		

*Sources which are not insignificant at 10%.

TABLE 4.2.5. ANALYSIS OF THE VARIANCE IN TOTAL LOST PREMIUM
GENERATED UNDER A NON-STATIONARY EXPECTED ORDER
RATE WITH A MAXIMUM AT 125% OF THE STATIONARY RATE.

SOURCE	DEGREES OF FREEDOM	SUM OF SQUARES	MEAN SUM OF SQUARES	F
PRIORITY POLICY (P)	1	116.04	116.04	12.774*
OPENING POLICY (O)	1	496.29	496.29	54.637*
DISTRIBUTION POLICY (D)	1	71.85	71.85	7.910*
P • O	1	.45	.45	.049
P • D	1	30.80	30.80	3.391*
O • D	1	2.73	2.73	.301
P • O • D	1	.00	.00	.000
ERROR	48	436.00	9.08	
TOTAL	55	1154.15		

*Sources which are not insignificant at 10%.

TABLE 4.2.6. ANALYSIS OF THE VARIANCE IN TOTAL LOST SALES
GENERATED UNDER A NON-STATIONARY EXPECTED ORDER
RATE WITH A MAXIMUM AT 125% OF THE STATIONARY RATE.

SOURCE	DEGREES OF FREEDOM	SUM OF SQUARES	MEAN SUM OF SQUARES	F
PRIORITY POLICY (P)	1	2311.84	2311.84	2.314
OPENING POLICY (O)	1	552.95	552.95	.553
DISTRIBUTION POLICY (D)	1	22.32	22.32	.022
P • O	1	503.58	503.58	.504
P • D	1	27.68	27.68	.028
O • D	1	1129.24	1129.24	1.130
P • O • D	1	201.44	201.44	.202
ERROR	48	47961.44	999.20	
TOTAL	55	52710.48		

*Sources which are not insignificant at 10%.

The analysis of variance indicates that lost premium is still significantly influenced by the priority and opening policy when the expected order rate fluctuates. Lost sales, however, is still unaffected by the storage policy options. In addition, the distribution policy and the interaction between the distribution and priority policies becomes significant with respect to lost premium under these conditions.

The influence of the interaction between priority and distribution policies is less for firms using the second priority policy alternative, i.e. ranking based upon expected revenue generation. For example the lost premiums associated with policies R.P.A and R.P.H are not significantly different while they are significantly different for policies S.P.A and S.P.H. Similarly, the lost premiums associated with policies S.T.A. and S.T.H. are significantly different while they are not significantly different for policies R.T.A. and R.T.H.

One can draw two conclusions. First, if the firm utilizes the best priority and opening policy, then the distribution policy will not significantly affect lost premium if order rates fluctuate. Second, the results of the experiments with the simulation model are fairly robust with respect to the order rate, therefore expanding the conditions under which the results are valid.

4.3 THE EFFECT OF ADDITIONAL CONTROLLED ATMOSPHERE STORAGE FACILITIES ON SYSTEM PERFORMANCE

In section 4.1 it was shown that under policy R.P.H the firm achieves a lower level of total lost premium than is achieved under any other policy option. In this section, the effect of adding CA rooms on total lost premium and lost sales, while operating under policy R.P.H. are presented in order to meet the second objective of the research.

The simulation model was run seven times under each of the capacity options described in section 3.4.1. Under these capacity options various types of additional capacity are utilized: one soft room (S), one hard room (H), one hard and one soft room (HS), two hard rooms (HH), two soft rooms (SS), two soft and one hard room (SSH), two hard and one soft room (HHS). The mean and standard deviation of total lost premium and total lost sales generated under each option are presented in Table 4.3.1.

The results indicate that the null hypothesis, adding another room does not improve lost premium performance, can be rejected, at the 10% level of significance, in favor of the alternative hypothesis only when the added room is designated soft, i.e. adding one hard room does not significantly improve lost premium. However, adding two rooms in any combination of hard and soft significantly improves total lost premium. There is no significant difference in total lost premium generated under policies HS, SS, and HH, implying that adding two rooms is more important than their designations as hard or soft.

Similarly, adding three rooms, in any combination of hard and soft, significantly improves lost premium over adding two rooms. There was no significant difference between either of the three room combinations, nor between the lost sales of any of the added capacity alternatives.

TABLE 4.3.1. MEAN AND STANDARD DEVIATION OF TOTAL LOST PREMIUM AND TOTAL LOST SALES GENERATED UNDER ALTERNATIVE STORAGE CAPACITY OPTIONS.

ADDITIONAL CAPACITY ALTERNATIVE	LOST PREMIUM (\$000)		LOST SALES (\$000)	
	MEAN	STD. DEV.	MEAN	STD. DEV.
H	25.04	2.32	496.99	36.62
S	22.25	1.82	515.75	36.83
HS	19.72	2.45	518.91	32.65
HH	19.78	2.63	524.28	20.72
SS	19.43	1.51	520.36	13.17
HHS	16.74	2.45	531.39	30.11
SSH	16.94	2.23	511.04	20.63

The insignificant difference in LS implies that waiting times for a significant number of orders did not fall below seven days when additional capacity is utilized.

Therefore, one can conclude that no rooms should be idle, i.e., it is better to use all rooms partially filled than to use fewer rooms filled to capacity. Furthermore, with the resources available now, the firm can reduce lost premium by nearly two-thirds without increasing lost sales, by following storage policy R.P.H and increasing the number of rooms utilized.

4.4 THE EFFECT OF CHANGES IN ORCHARD COMPOSITION ON SYSTEM PERFORMANCE

Three alternative orchard compositions were considered. The alternatives were designed to take advantage of excess orders for some varieties in an attempt to reduce the number of varieties grown by the firm. Each of the options involved discontinuing the production of Golden Delicious, Spartans, and Ida Reds in favor of increasing the production of some combination of the remaining soft and hard varieties. These combinations apply the production resources of the discontinued varieties to the production of McIntosh (M), half to McIntosh and half to hard varieties (MH), and to the production of hard varieties only (H). Storage policy R.P.H was used to define the operation of the CA storage.

The simulation was replicated seven times under orchard composition alternatives M, MH, and H. The mean and standard deviation of total lost premium and total lost sales are presented in Table 4.4.1. The results indicate that the difference between lost premium from option M and from option MH is not significant, but that lost premium from option H is significantly less than lost premium from option M and from option MH. The lost sales from option M is significantly less than lost sales from option MH which is significantly less than lost sales from option H. Lost sales from these alternative orchard compositions are significantly less than lost sales from any storage policy, order pattern, or capacity option.

The results indicate that reallocating production resources to McIntosh (M) causes a significant decrease in lost sales but a significant increase in lost premium. Similarly, allocating half of the production resources to McIntosh and half to the remaining hard varieties (MH) causes a significant increase in lost premium and a significant decrease in lost sales. Finally, the allocation of resources to the production of the remaining hard varieties (H) has the best resulting lost premium but the worst lost sales, from among the orchard composition alternatives.

One can draw several conclusions from this information. First, lost sales is most significantly affected by McIntosh and can be significantly improved by increasing the production of McIntosh. Second, increasing the production of McIntosh will have a detrimental effect on lost premium. Third, if the sum of lost sales and lost premium were used to rank the importance of the storage policies, capacity options, and orchard compositions, reducing the number of varieties grown and producing McIntosh would be the best of all possibilities.

TABLE 4.4.1. MEAN AND STANDARD DEVIATION OF TOTAL LOST PREMIUM AND TOTAL LOST SALES GENERATED UNDER ALTERNATIVE ORCHARD COMPOSITIONS.

ORCHARD COMPOSITION ALTERNATIVE	LOST PREMIUM (\$000)		LOST SALES (\$000)	
	MEAN	STD. DEV.	MEAN	STD. DEV.
M	45.42	5.22	177.36	44.10
MH	43.51	2.75	212.71	30.85
H	38.27	3.19	325.27	55.24

Although this option ranks far above all other options, the effect on realized income should be noted. Lost sales is essentially a measure of good will, i.e., a measure of the value of the customers who were forced to go elsewhere for their apples. This value does not show up on the income statement. However, lost premium does show up on the income statement. As a result the value of lost sales and lost premium are not directly comparable.

The conclusions drawn from this portion of the analysis depend upon the relative value of the two measures to the firm, the accuracy of the discount function estimate, and any decrease in operating costs that might result from consolidating production resources into fewer varieties. Therefore, drawing concrete conclusions based upon the information available is impossible.

4.5 AN EVALUATION OF THE USE OF SPECTRAL ANALYSIS TO MEASURE THE RELATIVE IMPORTANCE OF SYSTEM INPUTS

Spectral analysis was used at the end of chapter three to rank the varieties with respect to their influence on system performance. The spectral analysis results implied that the demand rates for the varieties contributed to lost premium and lost sales in an order that is inconsistent with their expected revenue generating potential. Therefore, if and only if the results of the spectral analysis are global with respect to all control policies, then the spectral ranking of the varieties improves performance more than the revenue ranking of the varieties.

The simulation experiments revealed that the revenue ranking yielded better performance than the spectral ranking. One can conclude, therefore, that the spectral estimates are not global and that the spectral ranking represents the relative importance of the varieties under the original policy exclusively and not under all policies.

If one assumes that at the unknown global optimum, the demand rates of each of the varieties should contribute equally to cost, then the spectrum of lost premium generated under the optimal policy R.P.H should exhibit less variation than the spectrum of lost premium generated under the original policy. In other words, the original policy is worse in terms of LP than the optimal policy R.P.H, so the demand rates should be contributing more unequally to LP under the original policy than under the optimal policy.

To explore this hypothesis, two signal to noise spectral ratios were calculated as suggested by Schruben and Cogliano [pp. 29-30]. The results are presented in Table 4.5.1. These results show the probability that the demand rates for the different varieties insignificantly affect lost premium.

One can draw two conclusions from these data. First, Empires, Golden Delicious, Spartans, and Ida Reds are equally insignificant under both policies. Second, that the percentage difference between the probabilities for McIntosh, Red Romes, and Red Delicious is lower under policy R.P.H than under the original policy. Since these probabilities were derived from a single signal run and a single noise run, these estimates are subject to considerable variability. Nevertheless, a cursory examination of the results supports the hypothesis that the difference between the relative contribution of each variety to lost premium decreases as one approaches the unknown global optimum.

TABLE 4.5.1. SIGNAL TO NOISE SPECTRAL RATIOS UNDER ORIGINAL AND OPTIMAL CONTROL POLICIES.

VARIETY	ORIGINAL POLICY		OPTIMAL POLICY	
	RATIO	PROBABILITY	RATIO	PROBABILITY
McIntosh	11.236	.001275	3.305	.055359
Red Romes	5.857	.010936	6.075	.009766
Red Delic.	11.999	.001014	3.461	.049143
Empires	.999	.500547	1.293	.362500
Golden Del.	1.059	.468684	.813	.611814
Spartans	2.483	.109941	1.200	.401386
Ida Reds	1.451	.305420	.8988	.558128

These results offer support for the utilization of spectral methods for the identification of allocative inefficiency in agricultural production systems. Typically, agricultural production systems have one or more significant random components within their production functions. Furthermore, the identification of an optimal input allocation typically involves finding an analytical solution to several necessary conditions for profit maximization. However, an analytical solution may not be global in a system with a significant random component, i.e., a numerical solution is more appropriate. Spectral analysis offers a way in which several necessary conditions for profit maximization can be checked simultaneously for systems exhibiting the randomness inherent to agricultural production.

In this chapter the results of the analysis are presented and several conclusions were drawn. In the next chapter the research is summarized, the limitations of the research are listed, and future research directions are suggested.

5. SUMMARY, LIMITATIONS, AND FUTURE DIRECTIONS

This research arose from the empirical observation that there is inconsistency among the policies used by New York apple packers to control controlled atmosphere (CA) storage facilities. This observation implies that there may be inefficiencies associated with the use of CA storage. However, since no firm appears to be operating efficiently, the management of these firms is satisfied with what may be sub-optimal performance.

The general objective of this research is to examine the inventory control policies used in apple packing plants and determine whether some consistent policy could improve system performance. The general objective is divided into three specific objectives. The first objective is to identify the best storage control policy for a variety of demand patterns and a given capacity. The second objective is to identify the best number of CA storage facilities to maintain under the optimal policy identified by meeting the first objective. The third objective is to identify the best allocation of production resources among apple varieties under the optimal operating policy.

To meet these objectives a computer simulation model of an apple packing plant located in the Hudson Valley region of the state of New York was constructed for use as a case study. Alternative CA operating policies were suggested by the nature of the environment within which the firm operates. The policies have three components. First, two policies for opening the CA facilities are compared. Second, two policies for allocating the storage capacity with the rooms are compared. Third, two policies for distributing different varieties among the CA facilities are compared.

The policies are compared on the basis of lost premium (LP) and lost sales (LS). Lost premium is the reduction in apple value caused by deterioration in apple quality and is a function of time. Two alternative forms of this function are considered since very little specific information is available on the loss of apple value due to deterioration. Lost sales are the value of sales lost because apples are not available when an order occurs. LP and LS are used because they give a full measure of the cost of improperly controlling the CA facility.

In addition to the control policy alternatives, the sensitivity of the results to several parametric changes are considered. The expected order rate is changed from stationary to non-stationary to determine how robust the optimal policy is with respect to structural changes in demand. Also, the number of CA room is increased to meet objective two. Finally, the orchard composition is altered by consolidating production resources to fewer varieties and to meet the third objective.

The computer simulation model is used to analyze each operating policy and the parametric changes. The alternatives are analyzed numerically so the solutions exhibit statistical variability. The source of the variation is uncovered by an analysis of variance.

The conclusions drawn can be summarized as follows:

- (1) The current policy is significantly worse than any of the options considered here and, therefore, inefficiencies exist and must be eliminated if the firm is to remain competitive.

- (2) The opening policy has the greatest effect on lost premium and the best opening policy is to open rooms when the preceding room of the same type is empty. Opening policy does not significantly influence lost sales.
- (3) The priority policy also significantly influences lost premium and should be based on expected revenue generation. Priority policy does not significantly influence lost sales.
- (4) Distribution policy does not influence lost premium under a stationary expected order rate. Distribution policy does not significantly influence lost sales.
- (5) Near the optimum, the distribution policy is unimportant under non-stationary expected order rates.
- (6) Utilizing additional rooms decreases lost premium significantly, if production does not increase. Therefore, more smaller rooms are better than fewer larger rooms.
- (7) Decreasing the number of varieties grown will increase lost premium and decrease lost sales significantly.
- (8) Inferences drawn from the results of spectral analysis apply only to local regions of the feasible set of alternatives in this case.

An additional conclusion can be drawn regarding the use of simulation and spectral analysis to examine microeconomics systems. The system studied in this research has several characteristics which preclude the use of more traditional methodologies. For example, the significant random components, the difficult to quantify policy alternatives, and the imperfect nature of the product market are all characteristics of this apple packing plant that are difficult to represent. Simulation appears to be an exceptional method for representing the uncertainties and risk associated with systems exhibiting these characteristics; particularly monopolistically competitive systems. Monopolistic competition describes the conditions faced by most firms but also the conditions most difficult to analyze because of the interdependence of market agents. Simulation offers a method for characterizing the behavior of a monopolistically competitive market without relying upon assumptions such as perfect competition or simple oligopoly.

These conclusions imply several general guidelines for firms similar to that of the case plant. First, inventory control has a significant influence on system performance and therefore more effort should be expended to improve policies associated with this aspect of plant management. Second, the policy components are not equipollent with respect to plant performance. Therefore, resources should be expended to improve the opening policy before the priority policy, and the priority policy before the distribution policy. Third, the firm should allow no rooms to remain idle. The results clearly demonstrate that it is better for the firm to fill all available rooms partially than to fill fewer rooms completely.

There are four conditions that are important in determining whether a firm is similar to the case plant. First, the number of varieties grown and packed by the firm is important because firms packing fewer varieties may not be experiencing the allocation problem faced by the case firm. If fewer varieties are sold it may be possible to eliminate conflict for storage capacity. Second, the number of CA facilities is important for the same reasons that the number of varieties is important. More CA facilities may

eliminate the allocation problem. Third, the distribution channels must be similar because other channels may, by their nature, define a policy. For example, if forward contracting became popular then a contract's maturity date and not inventory on hand would define CA opening dates. Fourth, the size of the operation, with respect to other firms in the industry, must be similar because larger firms may have more control over prices and therefore the importance of this policy may be diminished.

This research has several limitations. First, the results apply specifically to one case plant and therefore the conclusions are somewhat abrogated with respect to other packing plants. An analysis of the sensitivity of the results to changes in the expected order rate, discount function, CA capacity, and orchard composition parameters broadens the range of firms for which the results may be applied, but the results cannot be generalized. However, the model developed for this research can be easily modified to analyze the inventory policies of almost any apple packing firm.

Second, the absolute advantage of one policy over another could not be determined. This limitation is due to the lack of sufficient data on lost premiums, lost sales, and marginal costs. If empirical values could be attached to these variables, then the exact advantage of one policy over another could be established. These values, particularly the value of lost sales, are abstruse and therefore difficult to quantify. Although an estimate of the value of lost sales was made, the model assumed that all customers had the same value. This assumption is unrealistic, particularly for this company, which has a close relationship with its customers.

Finally, the effects of harvest and of the storage decision were not examined. Each variety has a particular period in the Fall during which it is harvested. These periods overlap, but not completely. Therefore, a critical decision facing the firm is which rooms to fill first if several rooms require the same apple variety. The storage decision is also critical. During the harvest, the firm's management decides which one of three routes the apples will follow: fresh market, regular storage, or controlled atmosphere storage. This decision is based upon price expectations for the current, intermediate, and long term markets, but was not considered in this research.

The conclusions and limitations adumbrate several directions for future research: system parameters, marketing alternatives, and harvest policies. System parameters are the factors in the model which define the environment within which the firm operates. Marketing alternatives refer to alternative distribution policies which may influence the system's performance through the storage control policies. Finally, harvest policies refer to rules for controlling the distribution of harvested apples to improve system performance.

Future research should consider the parameters which define the model. Particularly, the effect of time on the deterioration in the value of different apple varieties should be examined. Although the linear and exponential representations of the discount function indicate there is no difference in the ranking of the alternative policies, many decisions depend upon these values. For example, if the discount function is not the same for every variety, then some varieties may be allowed to deteriorate more than others without an increase in lost premium. This situation would imply that there are policies not considered in this research which may be closer to the optimum. Furthermore, a good estimate of these costs may allow the manager to identify the minimum expected cost of storing additional apples. For

example, an owner of CA storage would be able to calculate a break even rent based upon a marginal cost consisting of the cost of maintaining CA conditions and the cost in terms of value deterioration resulting from changing the CA allocation to accommodate additional apples. The sensitivity of the results to several of the assumptions regarding CA room classification, opening sequence, and non-case plant apples should also be explored. It was assumed that CA rooms classified as hard and soft could not be reclassified. It was also assumed that the opening sequence could not be changed. Finally, It was assumed that the "other" varieties stored in each CA room could be stored in any room of any type to fill for the CA rooms not completely filled with case plant apples. Future research should consider the sensitivity of the results to changes in these assumptions.

Marketing alternatives is also an area toward which future research should be oriented. For example it may prove profitable to contract with the broker in order to stabilize expected orders. If the firm could establish, during harvest, the dates and rate of distribution during the Winter and Spring, then storage policies could be constructed to maximize the quality of apples stored under controlled atmosphere. Also, given the imperfect nature of the market and the stochastic nature of the demand, a means of establishing prices in advance would greatly improve the ability of the firm to achieve partial equilibrium.

Finally, harvest policy should be studied. The apples are stored in CA storage in expectation of higher returns in the Spring. If the storage policy, or physical plant limitations, result in some positive minimum lost premium, then expectations should be adjusted to reflect that loss. The expected returns should be reduced by the expected lost premium and the quantity of apples allocated to CA storage should be reduced in recognition of this decrease in expected returns.

LIST OF REFERENCES

- Bressler, R.G., Jr. and R.A. King. Markets, Prices, and Interregional Trade. Raleigh, N.C.: Norman-Weathers Printing Company, 1978.
- Chamberlin, E. The Theory of Monopolistic Competition. Cambridge, Massachusetts: Harvard University Press, 1933.
- Chatfield, C. The Analysis of Time Series: An Introduction. 3rd ed. London: Chapman and Hall, 1984.
- Cogliano, V.J. "Sensitivity Analysis and Model Identification in Simulation Studies." Unpublished Ph.D. Dissertation. School of Operations Research and Industrial Engineering, Cornell University, Ithaca, NY, 1982.
- Ferguson, C.E., and J.P. Gould. Microeconomic Theory. 4th ed. Homewood, Illinois: Richard D. Irwin, Inc., 1975.
- Garrison, R.H. Managerial Accounting: Concepts for Planning, Control, Decision Making. Revised edition. Dallas: Business Publications, Inc., 1979.
- Hadley, G. and T.M. Whitin. Analysis of Inventory Systems. Englewood Cliffs, N.J.: Prentice-Hall Inc., 1963.
- Hillier, F.S., and G.J. Lieberman. Operations Research. 2nd ed. San Francisco: Holden-Day Inc., 1974.
- Hsaiao, J.C., and D.S. Cleaver. Management Science. Boston: Houghton Mifflin Company, 1982.
- Jacobson, S.H., and L.W. Schruben. "An Algorithm for Selecting Driving Frequencies in Frequency Domain Simulation Experiments." Technical Report, School of Operations Research and Industrial Engineering, Cornell University, Ithaca, NY, 1986.
- Law, A.M., and W.D. Kelton. Simulation Modeling and Analysis. New York: McGraw-Hill Book Company, 1982.
- Leibenstein, H. "Allocative Efficiency vs. 'X-efficiency'" American Economic Review. Vol. 56, No. 3, pp. 392-415, 1966.
- Logan, S.H. "An Annual Planning Model for Food Processing: An Example of the Tomato Industry." Giannini Foundation Research Report 332, Division of Agriculture and Natural Resources, University of California, 1984.
- Meier, R.C., W.T. Newell, and H.L. Pazer. Simulation in Business and Economics. Englewood Cliffs, N.J.: Prentice-Hall Inc., 1969.
- Priestley, M.B. Spectral Analysis and Time Series. Volume 1: Univariate Series. London: Academic Press Ltd., 1981.
- Pritsker, A.A.B. Introduction to Simulation and SLAM II. 2nd ed. New York: John Wiley and Sons, 1984.
- Rosenthal, R. "Combining Results of Independent Studies." Psychological Bulletin, Vol. 85, No. 1, pp. 185-91, 1978.

- Sanchez, P.J., and L.W. Schruben. "Significant Factor Identification using Discrete Spectral Methods." Technical Report 654. School of Operations Research and Industrial Engineering, Cornell University, Ithaca, NY, 1985.
- Schruben, L.W., and V.J. Cogliano. "Simulation Sensitivity Analysis: A Frequency Domain Approach." Proceedings of the 1981 Winter Simulation Conference. Atlanta, Georgia, 1981.
- Schruben, L.W., and V.J. Cogliano. "An Experimental Procedure for Simulation Response Surface Model Identification." Technical Report 669. School of Operations Research and Industrial Engineering, Cornell University, Ithaca, NY, 1985.
- Shah, S.A., M.R. Okos, and G.V. Reklaitis. "Simulation Modeling of a Sausage Manufacturing Plant." Transactions of the ASAE, Vol. 26, No. 2, pp. 635-40, 1983.
- Snedecor, G.W., and G. Cochran. Statistical Methods. Ames, Iowa: Iowa State University Press, 1967.
- Starbird, S.A. "Inventory Control in an Apple Packing Plant." Unpublished Ph.D. dissertation, Cornell University, 1987.
- Starbird, S.A., and M. Ghiassi. "Simulation Modeling of a Multi-Product Tomato Processing Plant." Transactions of the ASAE. Vol. 29, No. 1, pp. 324-330, 1986.
- Tomek, W.G., and K.L. Robinson. Agricultural Product Prices. 2nd ed. Ithaca, New York: Cornell University Press, 1981.
- United States Department of Agriculture, Crop Reporting Board, Economic Research Service. Capacity of Refrigerated Warehouses. Washington, D.C.: Government Printing Office, February 28, 1986.
- White, G.B. "Economic Opportunities for Fruit." New York State Agriculture 2000 Study. Albany, N.Y.: New York State Department of Agriculture and Markets, 1984.
- Working, H. "The Theory of Price of Storage." American Economic Review. Vol. 39, No. 6, pp. 1254-1262, 1949.