

December 1984

A.E. Research 84-22

BIOTECHNOLOGY AND THE DAIRY INDUSTRY: PRODUCTION COSTS AND COMMERCIAL POTENTIAL OF THE BOVINE GROWTH HORMONE

Robert J. Kalter, Project Director

Robert Milligan

William Lesser

William Magrath

Dale Bauman

Project Associates

Anya McGuirk

Elaine Andrysick

Margaret Grosh

**Department of Agricultural Economics
Cornell University Agricultural Experiment Station
New York State College of Agriculture and Life Sciences
A Statutory College of the State University
Cornell University, Ithaca, New York 14853**

It is the policy of Cornell University actively to support equality of educational and employment opportunity. No person shall be denied admission to any educational program or activity or be denied employment on the basis of any legally prohibited discrimination involving, but not limited to, such factors as race, color, creed, religion, national or ethnic origin, sex, age or handicap. The University is committed to the maintenance of affirmative action programs which will assure the continuation of such equality of opportunity.

December 1984

A.E. Research 84-22

BIOTECHNOLOGY AND THE DAIRY INDUSTRY:
PRODUCTION COSTS AND COMMERCIAL POTENTIAL
OF THE BOVINE GROWTH HORMONE

Prepared for

CORNELL UNIVERSITY
CENTER FOR BIOTECHNOLOGY

Committee for Economic Development

Prepared by

CORNELL UNIVERSITY
Department of Agricultural Economics
Department of Animal Science

Ithaca, New York

Robert J. Kalter, Project Director

Dale Bauman
Robert Milligan
William Lesser
William Magrath

Project Associates

Anya McGuirk
Elaine Andrysick
Margaret Grosh

CONTENTS

<u>Section</u>	<u>Page</u>
1	INTRODUCTION 1
	Agriculture and Biotechnology 1
	The Bovine Growth Hormone 3
2	PLANT DESIGNS, COSTS AND ECONOMIC EVALUATIONS 5
	Project Design and Cost Estimating Procedures 5
	Procedures Adopted 6
	Review of Growth Hormone Production Technology 7
	Biological Development 7
	Large Scale Production 9
	Plant Capital and Operating Costs 14
	Capital Cost 14
	Major equipment 14
	Total capital costs 15
	Operating Costs 15
	Direct production costs 19
	Plant overhead 19
	Administrative expenses 20
	Distribution and marketing expenses 20
	Summary 20
	Economic and Financial Evaluation 20
	The Model 23
	Data and Assumptions 23
	Cost related inputs 23
	Planning horizon 26
	Economic and tax values 26
	Results 28
	Sensitivity Analysis 30
	Probability of Commercial Success 33
3	THE ECONOMIC IMPLICATIONS OF bGH FOR FEED REQUIREMENTS, CROP ROTATIONS AND FARM PROFITABILITY 35
	Representative Farms 35
	Representative Farm Characteristics 36
	Farm production costs 38
	Representative Farm LP Tableau 42
	The Feeding Program 44
	Dietary Adjustments Following Application of bGH 46
	Results of Ration Reformulation 47

	<u>Page</u>
Effect of Hay Crop Quality	50
Effect of Forage Composition	50
Effect of Production Level	53
Return Per Day of Administration	54
Results of Representative Farm Analysis	54
Normal Intake	54
Increased Intake Scenario	60
Response to Changing Milk Prices	65
Summary	65
4 BOVINE GROWTH HORMONE: THE ADOPTION ISSUE	71
Diffusion and Adoption Models	72
Applying Diffusion Models to bGH	75
Data Collection Procedures and Survey Results	76
Survey Responses	77
Feasibility	77
Date to first trial	77
Price response	77
Herd response	80
Other Factors	81
Identifying Fast Adopters	82
Projection of Diffusion Rates	84
Estimating Diffusion Functions	86
Summary and Conclusions	90
5 CONCLUSIONS	91
REFERENCES	92
APPENDIX A Major Equipment List bGH Fermentation Plant (1/2 million cow daily capacity)	A-1
APPENDIX B Major Equipment List bGH Fermentation Plant (1 million cow daily capacity)	B-1
APPENDIX C Major Equipment List bGH Fermentation Plant (2.5 million cow daily capacity)	C-1
APPENDIX D Major Equipment List bGH Fermentation Plant (3 million cow daily capacity)	D-1
APPENDIX E Major Equipment List bGH Fermentation Plant (3.5 million cow daily capacity)	E-1

	<u>Page</u>
APPENDIX F Major Equipment List bGH Fermentation Plant (4 million cow daily capacity)	F-1
APPENDIX G Major Equipment List bGH Fermentation Plant (4.5 million cow daily capacity)	G-1
APPENDIX H Major Equipment List bGH Fermentation Plant (5 million cow daily capacity)	H-1
APPENDIX I Major Equipment List bGH Fermentation Plant (5.5 million cow daily capacity)	I-1
APPENDIX J Major Equipment List bGH Fermentation Plant (6 million cow daily capacity)	J-1
APPENDIX K Major Equipment List bGH Fermentation Plant (6.5 million cow daily capacity)	K-1
APPENDIX L Major Equipment List bGH Fermentation Plant (7 million cow daily capacity)	L-1
APPENDIX M Operating Costs for the 0.5 Million Cow bGH Production Facility	M-1
APPENDIX N Operating Costs for the 1.0 Million Cow bGH Production Facility	N-1
APPENDIX O Operating Costs for the 2.5 Million Cow bGH Production Facility	O-1
APPENDIX P Operating Costs for the 3.0 Million Cow bGH Production Facility	P-1
APPENDIX Q Operating Costs for the 3.5 Million Cow bGH Production Facility	Q-1
APPENDIX R Operating Costs for the 4.0 Million Cow bGH Production Facility	R-1
APPENDIX S Operating Costs for the 4.5 Million Cow bGH Production Facility	S-1
APPENDIX T Operating Costs for the 5.0 Million Cow bGH Production Facility	T-1
APPENDIX U Operating Costs for the 5.5 Million Cow bGH Production Facility	U-1
APPENDIX V Operating Costs for the 6.0 Million Cow bGH Production Facility	V-1

	<u>Page</u>
APPENDIX W Operating Costs for the 6.5 Million Cow bGH Production Facility	W-1
APPENDIX X Operating Costs for the 7.0 Million Cow bGH Production Facility	X-1
APPENDIX Y DCF Cash Flow Results	Y-1
APPENDIX Z Feed Rations and Costs Per Cow by Production Period, Hay Type, Annual Milk Production, bGH Response and Forage Composition with Normal Intake	Z-1
APPENDIX AA Feed Rations and Costs Per Cow by Production Period, Hay Type, Annual Milk Production, bGH Response and Forage Composition with Normal Intake	AA-1
APPENDIX AB Information on bGH Provided to Respondents and Questionnaire	AB-1
APPENDIX AC Projections of bGH Use Over Time	AC-1

TABLES

<u>Tables</u>	<u>Page</u>
1 Ratio Factors for Estimating Capital Investment Items Based on Delivered Equipment Cost	16
2 Plant Capital Costs	17
3 Typical Operating Cost Categories	18
4 Annual Plant Operating Costs	21
5 Principle Economic, Institutional and Policy Assumptions for "Reference Case" DCF Analyses	25
6 Price to Produce Required for Economic Feasibility	29
7 Results of Sensitivity Analysis	31-32
8 Preliminary Evaluation of bGH Commercial Viability Given Alternative Milk Prices and Feed Costs	33
9 General Characteristics of Representative Farms	36
10 Detailed Characteristics of Representative Farms	37
11 Nutrient Content of Available Feeds	39
12 Variable Costs and Labor Requirements	40
13 Prices Used by the Linear Programming Model	41
14 Production by Groups	45
15 Comparison of Annual Feed Requirements by Response to bGH and Feed Intake Assumption in the Base Case	48
16 Comparison of Percent Increases in Feed Requirement by Response to bGH and Feed Intake Assumption for Base Case	49
17 Comparison of Annual Feed Requirements Per Cow by Hay Crop Quality and Intake Assumption for 16,000 Production and Half-and-Half Forage Composition	50

<u>Table</u>	<u>Page</u>
18 Effect of Hay Crop Quality on Percent Increases in Per Cow Feed Requirements with a 25.6% Response to bGH	51
19 Per Cow Comparison of Annual Feed Requirements by Response to bGH and Forage Composition for 16,000 Production and Normal Intake Assumption	51
20 Per Cow Comparison of Annual Feed Requirement by Response to bGH and Forage Composition for 16,000 Production and Enhanced Intake	52
21 Comparison of Changes in Feed Requirements by Response to bGH, Forage Composition, and Intake Assumption for 16,000 Production	52
22 Effect of Milk Production on Per Cow Response to bGH	53
23 Increase in Feed Requirement for Different Milk Production Levels with bGH	54
24 Per Cow Increase in Return Over Feed and Milk Marketing Costs Per Day of Administration of bGH	55
25 Impacts of bGH on Forage Only Representative Farms by Response Rate and Average Annual Milk Production with the Normal Intake Assumption	56
26 Impacts of bGH on Corn Grain Representative Farms by Response Rate and Average Annual Milk Production with the Normal Intake Assumption	57
27 Impacts of bGH on Crop Sales Representative Farms by Response Rate and Average Annual Milk Production with Normal Intake Assumption	58
28 Representative Farm Changes Due to bGH Response with 16,000 Pounds Base Production and Normal Intake Assumption	59
29 Representative Farm Changes Due to bGH Response with 13,000 Pounds Base Production and Normal Intake Assumption	60
30 Impacts of bGH on Forage Only Representative Farm by Response Rate with 16,000 Pound Base Production and the Enhanced Intake Assumption	61

<u>Table</u>	<u>Page</u>
31 Impacts of bGH on Corn Grain Representative Farm by Response Rate with 16,000 Pound Base Production and the Enhanced Intake Assumption	62
32 Impacts of bGH on Crop Sales Representative Farm by Response Rate with 16,000 Pound Base Production and the Enhanced Intake Assumption	63
33 Representative Farm Changes Due to bGH Response with 16,000 Pounds Base Production and the Enhanced Intake Assumption	64
34 Return Over Variable Cost on Forage Only Representative Farm for Selected Milk Price and Response Levels	65
35 Return Over Variable Cost on Corn Grain Representative Farm for Selected Milk Price and Response Levels	66
36 Return Over Variable Cost on Crop Sales Representative Farm for Selected Milk Price and Response Levels	67
37 Comparison of In-Person and Mail Survey Responses	78
38 Selected Characteristics of Respondent Farms, New York, 1984 ..	79
39 Perceived Feasibility of bGH Use by New York Dairymen, 1984 ...	79
40 Expected Time to First bGH Trial by New York Dairymen, 1984 ...	80
41 Relationship of Year of First bGH Trial and Average Herd Size New York Dairymen, 1984	83
42 Distribution of Dairy Farmer by Adopter Category and Barn Type	84
43 Data Treatments for Computing Adoption Rates	85
44 Logistic Diffusion Curve Fits to bGH Adoption Data, New York Dairymen, 1984	89

ILLUSTRATIONS

<u>Figure</u>	<u>Page</u>
1	Scheme for bGH Gene Isolation and Modification 8
2	Flowsheet for Production of Purified Bovine Growth Hormone 11
3	Lay-Out of the Fermentation Area for the Production of Purified Bovine Growth Hormone 12
4	Schematics of Gel-Filtration Chromatography Columns for Final Purification of Bovine Growth Hormone 13
5	Flow Diagram for Simulation Model with Input Q_0 24
6	Schematic of LP Matrix for the Representative Farms 43
7	Impacts of Milk Market Prices on Return Over Variable Costs and Farm Returns for Representative Farms at 19.2 Percent bGH Production Response (13,000 Base Production) 69
8	Impacts of Milk Market Prices on Return Over Variable Costs and Farm Returns for Representative Farms at 19.2 Percent bGH Production Response (16,000 Base Production) 70
9	Expected bGH Adoption with Injections 87
10	Expected bGH Adoption with Implants 88

Section 1

INTRODUCTION

Techniques such as recombinant DNA and gene transfer promise major benefits to both consumers and producers in areas like medicine, pharmaceuticals, chemicals and agriculture. This "new biotechnology" continues the long history of technological change and innovation which has resulted in more efficient production processes, improved product quality and the release of economic resources for alternative uses. As such, modern advances in biotechnology join technical change resulting from research in electronics and computers, robotics and large scale mechanization in helping to increase productivity and improve the world's living standard.

Advances resulting from biotechnology research, like those in electronics, have the potential for being different from past technological advances. That difference relates to the potential for accelerating the rate of productivity change above any level previously experienced in the human attempt to harness biological systems for mankind's benefit. This potential results from both the character of the "new biotechnology" (that is, the understanding of the fundamental chemistry of life) and the apparent compression of time required for basic research results to find their way to practical application. Moreover, food and fiber production is the world's largest industry thereby magnifying the impacts resulting from major technological advances.

Economically and socially, this rapid acceleration in productivity change has both beneficial and adverse implications. If the promise of the "new biotechnology" is fulfilled, the benefits to society are obviously greater economic efficiency and an improved standard of living. On the other hand, the speed with which new biotech-related products or processes are commercialized will impact established methods of conducting the world's economy with resultant dislocations, equity impacts and alterations in social structure. In the short run, improvements in economic efficiency can rarely be made without making some sectors worse off while improving others.

The extent and nature of economic changes resulting from new technologies are consequently of major interest to both public and private decisionmakers likely to be affected by their introduction. It is in the spirit of this line of inquiry that this research is carried out.

AGRICULTURE AND BIOTECHNOLOGY

Already, substantial efforts are underway to apply the emerging biotechnologies to agriculture. Improvement of existing plant varieties and the development of modified plant species is one major line of inquiry. Products to inhibit the effects of early frost, herbicides and pests are all being actively researched. Transferring nitrogen fixation traits from legumes to cereals, breeding more drought resistant or salt tolerant varieties, and cloning superior seeds add to the list. This only provides a brief indication of research underway or contemplated in the area of plant

science. As the genetical and chemical processes of growth, reproduction and survival are better understood, lines of inquiry will continue to develop.

Of equal importance is the application of biotechnology to food processing and animal production. Synthetic production of flavors and other constituent components of prepared food, and even the production of raw materials, like cocoa oil, may result from gene transfer technology. Manipulation of lactic acid bacteria to enhance productivity and reduce their sensitivity to bacteriophage could provide important economic benefits. Hundreds of other food processing applications for biotech research are probable but are likely to proceed slowly in light of the low level of R & D spending traditionally undertaken by this sector.

Application of the "new biotechnology" to animal production, promises even earlier application of a number of new techniques. Breakthroughs such as embryo sex selection, storage and transfer along with twinning are a practical reality. Commercial ventures are being established to apply these methods to high-valued animals.

These methods, although compressing the time period necessary for promoting changes in productivity, still require improvements to occur as a result of new generations. There are more revolutionary biotech developments which rely on recombinant DNA processes that can result in rapid changes in animal productivity. These new biological tools lower the production costs for naturally occurring substances useful in regulating animal physiology and health, and promise far-reaching economic implications for agriculture. Examples include the production of vaccines and antibiotics for disease control, feed supplements, monoclonal antibodies for disease resistance and diagnosis, and hormones and growth regulators. rDNA methods have already produced new products to control diarrhea in pigs and calves, cure sleeping sickness, and prevent foot and mouth disease. Polyether ionophore antibiotics and protected amino acids are being developed to enhance feed efficiency in ruminants by shifting rumen fermentation to produce a higher energy yield from the same feed (Biotechnology, p. 857). Many other products can be expected as scientific understanding of the natural control processes in animals are better understood.

The potential for rapid and widespread commercial adoption of new advances stemming from biotechnology research would appear to set the stage for a dramatic structural change in agriculture and the food processing industry. Issues ranging from marketing to land use, from price support policy to the structure of agriculture will become of increasing concern as these new techniques prove commercially feasible. Both public and private decisionmakers who recognize the possibilities early in the evolutionary stage will be in a better position to respond to the technical revolution which will follow. The purpose of this study is to investigate, in greater detail, the changes likely to be induced by one such biotechnology related new product. That product, the bovine growth hormone (bGH), and its economic implications for the dairy industry are the focus of this report.

THE BOVINE GROWTH HORMONE

Bovine growth hormone (bGH) is a naturally occurring protein produced by dairy cattle. It is one factor regulating the volume of milk production. The gene responsible for its production in animals causes minute quantities to be manufactured by the pituitary gland. Consequently, the isolation and extraction of the protein from animals is expensive, time consuming and limited to the quantities which can be obtained from the pituitary glands of slaughtered animals.

However, the gene responsible for bGH production has been isolated and transferred from animal to ordinary bacteria cells (Miller et al., 1980). The altered bacteria can then be reproduced on a large scale by standard fermentation techniques and the resulting growth hormone (which is produced by the bacteria) can be isolated, purified and made available for commercial use in large quantities. When injected into dairy cows at the rate of 44 milligrams per cow per day (a bit over 1/1,000th of an ounce), the hormone has resulted in significant increases in milk production. Most of the research to date has involved short term studies (a few days or weeks) with pituitary derived hormone (see review by Bauman and McCutcheon, 1985). In 1982, the first studies (short term) with recombinantly produced bGH were conducted and results demonstrated an increased milk yield similar to that obtained with pituitary bGH (Bauman, et al., 1982a). Bauman et al. (1985) have recently completed a long term study utilizing both recombinantly produced and pituitary derived bGH. Overall, results have demonstrated a 10 to 40 percent increase in milk yield. The response to injections is rapid (2 to 3 days) and persists as long as treatment is continued.

With this type of potential, various private sector firms are investigating the commercial production of bGH. Several have announced their intention to bring bGH to the commercial market as their first biotechnology product.¹ Commercial introduction, however, requires Food and Drug Administration (FDA) approval. The safety of treated animals and their offspring, and of the animal products sold for human consumption, is of critical importance in gaining such approval. Although it is difficult to predict the specific FDA requirements in terms of long-term trials and research results, it seems likely that the bGH approval process will be expedited in light of the product's potential importance and the fact that it is a naturally occurring protein. Other growth hormones, of a similar chemical composition, have been isolated from poultry and hogs. For these species, as well as beef cattle, trials have indicated that a substantial impact on animal growth can be obtained by injecting supplemental quantities of the naturally occurring hormone. Treatment with growth hormone increases feed efficiency (gain/unit of feed) and shifts body composition toward increased muscle and decreased fat (Bauman et al., 1982b).

Eventual FDA approval, however, does not establish bGH's commercial viability nor provide any creditable evidence regarding its potential economic and social impacts. The purpose of this study is to investigate those implications from a number of different perspectives under the assumption that FDA approval will eventually be granted. A series of

¹Recently, Dr. H. A. Schneiderman (Senior Vice President for Research and Development, Monsanto Co.) indicated that Monsanto anticipated market introduction of bGH in 1988 (Chem. and Eng. News, Dec. 24, 1984).

economic questions concerning the commercial introduction of a bGH product serve as the focal points for this research. Included are at least five major issues. This publication reports on research results concerning the first three issues relative to bGH for lactating dairy cows. A subsequent report will deal with the last two concerns.

First, the cost of bGH commercial production, using genetically engineered bacteria, must be ascertained before the economic viability of the product can be judged. Consequently, a cost engineering analysis of appropriate fermentation facilities was completed. Particular attention was given to the size of production facilities required and whether substantial scale economies exist in production.

Second, hormone production costs, alone, do not indicate the commercial viability of the product. The ultimate market price of the product, as opposed to its cost of production, and additional feed requirements necessary to sustain additional milk production as well as other changes in production costs, must be balanced against the additional revenue derived from hormone use. Investigation of this overall profitability question must pay particular attention to hormone-induced changes in milk production and feed requirements. Since a number of important economic parameters may, at this stage, be uncertain, the analysis presented below seeks to appraise the sensitivity of results to a range of values for the important influencing variables.

Third, the adoption rate for bGH will depend upon the production response achieved on commercial farms, the expected net return from the hormone, and the extent and nature of the information circulated about the product. A number of technical issues could also affect the response rate by dairy farmers. Nonetheless, the timing and magnitude of commercial adoption is a critical element in ascertaining the macro economic and social implications of introducing bGH in the market place.

Fourth, the market implications of introducing a product such as bGH are of substantial interest. Currently there are about 11.1 million dairy cows in the United States. With this production base, an annual milk surplus is currently generated with today's market economics. Normal genetic improvement and the commercial usage of other biotechnology processes (other than bGH) will add a substantial increase in milk production by the turn of the century. With the production increases promised by bGH and the expected slow growth in milk demand, the need for a major reduction in the number of producing cows and dairy farms in the United States seems inevitable. The analytical question pertains to the magnitude and timing of this reduction. In addition, the introduction of growth hormone with the attendant possibility of changes in feed requirements may have implications for land use, cropping patterns and rotations, and the comparative advantage in dairy production among and within regions of the United States. All of these implications are of substantial interest to private decision-makers and those interested in public policy issues. Research concerning this and the following areas will be reported in a future publication.

Finally, the introduction of growth hormone products will also have profound impacts on the nature of federal dairy support policy. Clearly, both federal price support and marketing order programs will be placed under severe short run stress if the promised potential of bGH is realized.

Section II

PLANT DESIGNS, COSTS AND ECONOMIC EVALUATIONS

Development of a growth hormone production facility requires the careful application of engineering design and cost estimating principles. A number of plant configurations are theoretically possible and, for each possible configuration, a host of technical, logistical and engineering factors must be considered. This Section surveys these plant design issues and develops preliminary plant capital and operating cost estimates. The results of this analysis provide the basis for an overall economic evaluation of growth hormone's commercial potential in the next Section.

PROJECT DESIGN AND COST ESTIMATING PROCEDURES

Methods for developing engineering designs and associated cost estimates for new facilities, such as those that would be used to produce bovine growth hormone, cover a wide range of sophistication and depth. Normally, a series of designs and design estimates is developed, each of which becomes more detailed and accurate than those previously provided (U.S. Congress, 1979, p. 189; Peters and Timmerhaus, 1980). Such a series can begin with initial or rough designs which are little more than "back of the envelope" material flows and cost predictions. Estimates such as these are generally used to ascertain whether a particular plant, process or technology warrants further investigation and the cost estimates are probably accurate only within the range of plus or minus 30 percent.

Next, a preliminary design stage is initiated, where a plant's subsystems are defined and a thorough analysis of major components is undertaken. However, component subprocesses are not investigated in detail. At this stage, different plant designs and technologies are analyzed and evaluated for suitability, and cost estimates can be developed through more detailed estimation procedures. Usually, however, exact equipment specification is not provided and detailed drafting is minimized (Peter and Timmerhaus, p. 13). Thus, the accuracy of cost estimates is still usually no better than plus or minus 25 to 30 percent.

During detailed design specific components and materials for each process and subprocess are identified along with associated cost estimates. All material and process heat flows are accounted for and process flow diagrams are developed for each plant component. Technical and engineering decisions with respect to plant component design are based upon optimum design procedures that account for the economic, environmental and logistical factors involved (including issues of overall optimization versus component optimization). Cost estimates for this type of design may be accurate to within plus or minus 20 percent.

Final plant design results in a complete process design, specification of all equipment requirements, and precise cost estimates based upon all materials, components, and labor. Construction blueprints and cost estimates accurate to within plus or minus 10 to 15 percent of the eventual capital costs (along with operating cost estimates) are provided.

Procedures Adopted

For a feasibility study, it would be most desirable to have available detailed or final plant design specifications and costs. However, to be useful, these designs would need to be configured so as to fit the specific circumstances found at the potential plant site.

On the other hand, initial design approaches do not provide adequate data to evaluate accurately alternative technical processes or to assess the possibility of commercial success for a proposed facility. Thus, an approach compatible with the preliminary design technique (or a stage somewhere between preliminary and detailed design) appears most suited to the problem at hand. Such an approach would allow the development of appropriate technical processes, would permit accurate evaluation of technical feasibility and the trade-offs between competing techniques, and would yield more realistic cost estimates.

Even with this more narrowly defined approach to plant design, however, a number of techniques can be used to derive specific capital and operating cost values (Peters and Timmerhaus, p. 157 and pp. 176-206). As Peters and Timmerhaus point out:

The choice of any one method depends on the amount of detailed information available and the accuracy desired. Seven methods are outlined ... , with each method requiring progressively less detailed information and less preparation time. Consequently, the degree of accuracy decreases with each succeeding method (p. 176).

For determining capital costs, the first two methods -- a detailed-item estimate and a unit-cost estimate -- require either completed plant design drawings and specifications and/or detailed equipment purchase price information. The third method -- percentage of delivered-equipment cost -- estimates total capital expenditure in two steps. First, purchased equipment necessary to complete a plant is identified and the delivered cost determined. Second, other items of direct and indirect capital cost are estimated as percentages of the delivered-equipment cost. Other direct costs include components such as equipment installation, piping, instrumentation and controls, electrical, buildings, land, service facilities, and yard improvements. Indirect costs include construction expenses, engineering and supervision, and the contractor's fee. "The percentages used in making an estimation of this type should be determined on the basis of the type of process involved, design complexity, required materials of construction, location of the plant, past experience, and other items dependent on the particular unit under consideration" (Peters and Timmerhaus, p. 179).

The percentage of delivered-equipment cost technique is commonly used for preliminary or feasibility study estimates like that undertaken in this research (Peters and Timmerhaus, p. 179). Consequently, the approach is adopted here for use in determining the capital cost estimate for

alternative plant designs. Several techniques can be used to obtain the cost of delivered equipment, including actual price quotations from manufacturers and/or cost engineering estimates corrected for inflation and equipment delivery (Guthrie, 1974). The percentages used to calculate other direct and indirect costs are taken from Peters and Timmerhaus (p. 180).

Operating costs are developed in a similar fashion. Specific operating cost components are identified and annual estimates are determined using widely accepted cost engineering practices (Peters and Timmerhaus, pp. 191-208). Additional factors, such as taxes, working capital, financing and contingencies, are handled directly by the discounted cash flow model to be used for determining the overall economic feasibility of alternatives presented.

REVIEW OF GROWTH HORMONE PRODUCTION TECHNOLOGY

Technologies for the production of the hormone from genetically engineered bacteria are well established. The following process components must be considered in the design of a production facility.

- o Fermentation;
- o Cell Disruption;
- o Purification;
- o Formulation; and
- o Plant support.

To appreciate the logistical and technical problems associated with the design of these process components, an understanding of the microbiology, chemistry and engineering principle involved is required. Therefore, the following discussion will review technical considerations in the design of these major process components.

Biological Development

Figure 1 shows a simplified protocol for bGH gene isolation and manipulation. Gene isolation starts with the homogenation of bovine pituitary tissues and, after removing insoluble debris, running the extract through a chromatography column. bGH and many other mRNA's have a polyadenosine (polyA) tail that can base pair with an oligo-dT or oligo-U attached to cellulose or Sephadextm in an affinity chromatography column. After using a high salt solution to elute the column, the various mRNA's can be separated by means of gel electrophoresis. A band corresponding to immature bGH with poly-A tail can be extracted and treated with reverse transcriptase to yield a double-stranded nucleic acid. HindIII linkers can be added and the gene can be ligated into the HindIII site of the standard laboratory plasmid pBR322. At this point the gene is copied and can be grown in larger numbers for further manipulations.

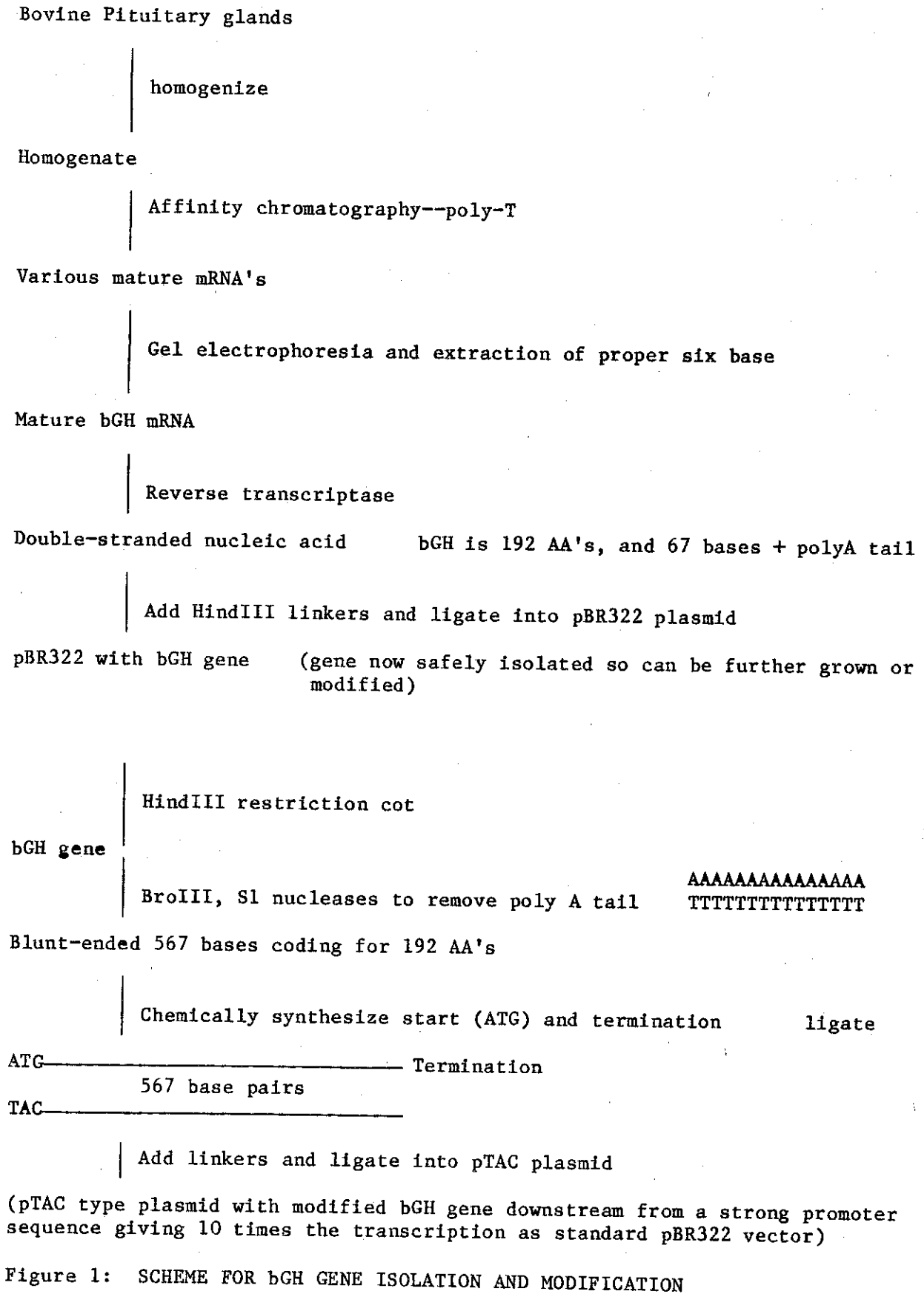

Martial (1979) discusses the RNA sequence expected when using hGH or rat GH. bGH would have a similar sequence (Seeburg et al., 1983). The codons designated by minus signs, with the rest of the codons, would code for an immature pro-GH that would be processed into a mature GH in an eucaryotic system. In order to get E. coli to express a mature GH these codons (-1 to -26) and the flanking non-coding regions must be removed.

Various exonucleases such as EXOIII followed by S1 are used to "trim down" the gene to the appropriate length of about 570 base pairs that code for the 191 AA's of mature GH followed by the termination codon (TAG). The next requirement is to add ATG, the start codon, to the front of the gene.¹ To do this, a convenient restriction endonuclease site is found towards the beginning of the gene and cut. Then, an ATG is chemically synthesized and attached to the gene. Goeddel, et al. (1979) illustrate how this would work in the case of human GH. The resulting gene coding for mature GH is then ligated into a plasmid with a good promoter such as pTAC. With this plasmid, more than ten times the transcriptional efficiency is expected compared with more common laboratory plasmids (e.g., pBR322). Goeddel and others have found that 10^5 to 10^6 molecules of product per cell are created. With the pTAC vector, 10^6 to 10^7 molecules of bGH per cell could reasonably be expected.

The E. coli strains considered as logical hosts for the bGH gene include SF8 and HB101. SF8 grows to twice the optical density of HB101 but its complete genotype has not yet been reviewed. HB101 has a doubling time of about 20 minutes at 37°C. in a rich medium. Its mutations include: hsdS20, inactivation of host restriction system that could destroy the plasmid; recA13, inability for genetic recombination to occur; and a variety of nutritional mutations. The mutations affecting nutrition permit conformance with the National Institutes of Health biological containment standards but require a rich (and expensive) growth medium. What follows is based on using LB medium (8g Bacto-tryptone, 5g yeast extract, 5g NaCl per liter of H₂O) supplemented with ampicillin. Further investigation may result in choosing a minimal media supplemented with appropriate nutrients (should the cost be less while allowing for good cell growth rates).

Large Scale Production

For purposes of discussion, the following descriptions of a bGH production facility will focus on a plant with an installed capacity of 75 kg per day of high-purity product. This capacity would be sufficient to inject 2.5 million cows when the hormone is administered for 225 days per year in 44 mg doses and the plant is assumed to operate at a 90 percent

¹A question arises as to the effect of adding a start codon, which codes for methionine, to the bGH gene. Goeddel, et al. (1979) note that most bacterial proteins do not start with methionine suggesting that this residue is cleaved away. Their results were an active human GH and there is no reason to believe that less success would result from a bovine GH project.

load factor. Once the basic production scheme is discussed, capital and operating costs will be estimated for a range of plant scales.

It is assumed that a product yield of 0.09g per liter could conservatively result based on 10^5 molecules of product per cell. This factors in a 50 percent loss due to scale-up. Since the pTAC plasmid is expected to produce ten times more, the maximum yield could be 0.9g per liter. However, on scale-up there is likelihood of incomplete mixing and higher temperature due to heat generation.

The proposed process for the industrial scaled production of recombinant bGH (Figure 2) starts with a 2500 l seed culture tank from which the fermentors are inoculated. The inoculum consists of *E. coli* grown on "LB" medium in the presence of ampicillin. A total of 12 stainless steel fermentors, 75,000 l actual volume each, are arranged in three parallel lines of four fermentors per line (Figure 3). This arrangement permits semi-continuous plant operations since one line can be fermenting while a second is cleaned/prepared and the third is shifted. Fermentors are installed with an air incinerator and with pH, aeration, temperature, and foam controls. Sterile air is supplied to the fermentor through a glass wool filter unit of 500 ft³/min capacity.

The cells are separated from the broth in a stainless steel pressure filter-thickener which continuously discharges broth and a stream of thickened slurry containing the cells. The filter area is 500 ft² and the device operates at 80 gal/min. Fermentation broth with cells is pumped into the filtration unit by means of a stainless steel positive displacement pump, 80 gal/min capacity. (Unless otherwise noted, all other pumps used in the process are of the same characteristics as the one just mentioned.) Separated cells are then resuspended in a mixing jacketed vessel to form a thick cell suspension. The suspension is then fed into a stainless steel disruptor filled with glass beads (Impandex Inc. Dyno-Mill) from which a lysed cell suspension is discharged continuously. Disruptor capacity is 500 gal/hr.

The effluent from the disruptor is pumped by a stainless steel positive displacement pump at a rate of 10 gal/min into a 10 hp stainless steel suspended jacket centrifuge connected in series to another centrifuge of the same characteristics. The first centrifuge removes insoluble cell debris while the second has $(\text{NH}_4)_2\text{SO}_4$ added to precipitate out proteins. The supernatant, containing nucleic acids, saccharides and other substances is discarded. The precipitated proteins are resuspended in two 800 l mechanically agitated vessels prior to gel-filtration chromatography.

Chromatography columns are arranged as shown in Figure 4. A total of four parallel units of four columns each work continuously to purify bGH. Columns are 30" in diameter and 3 ft. high. They are glass-lined and are packed with agarose beads with a capacity of 200 l. The first two (1 and 2) columns of each unit are designed to collect protein fractions of molecular weight between 20,000 and 23,000 D. The second set of two columns are designed to collect a fraction corresponding to about 21,666 D, the weight of the bGH product. Discarded fractions are removed after the

Figure 2: FLOWSHEET FOR PRODUCTION OF PURIFIED BOVINE GROWTH HORMONE

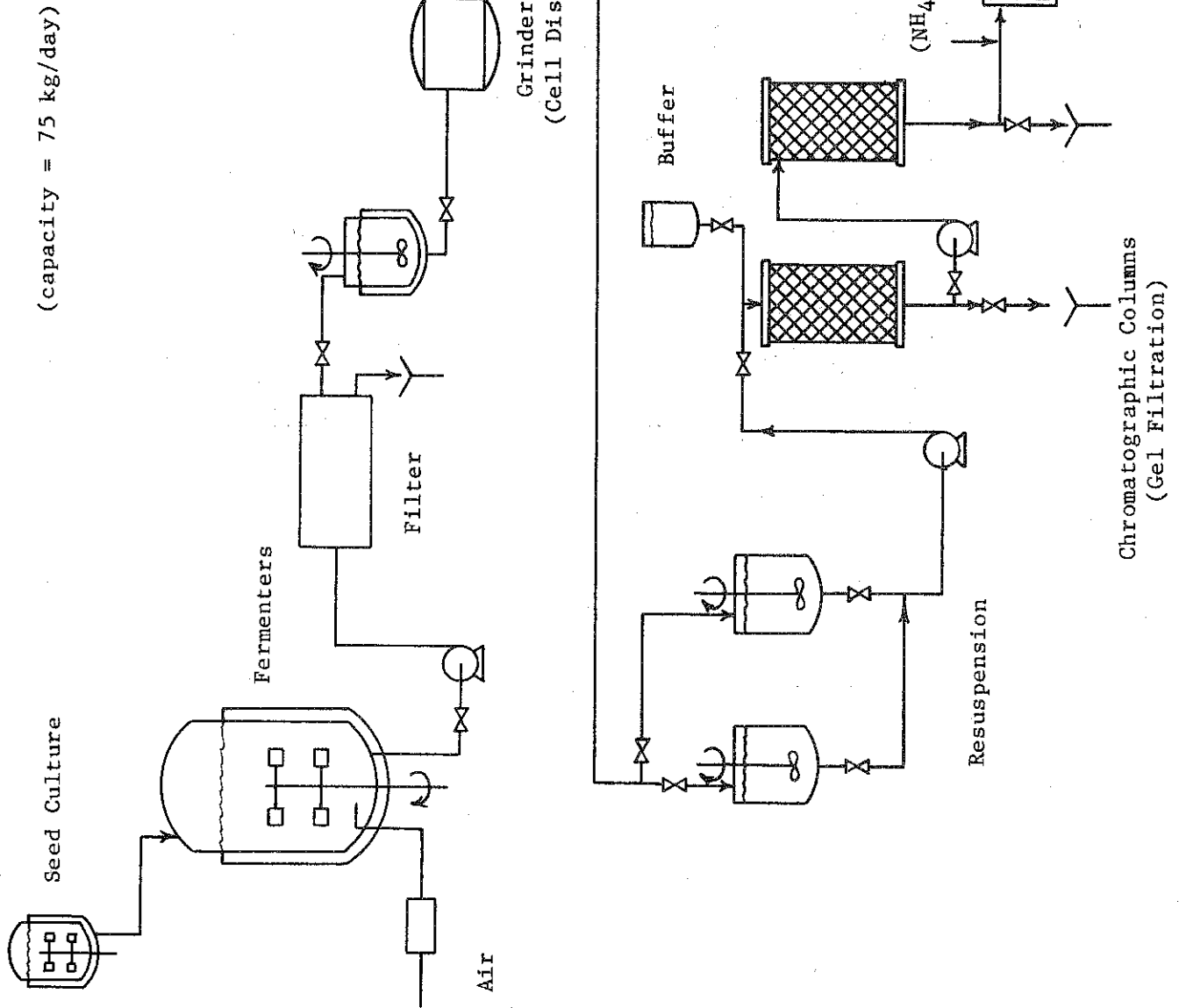
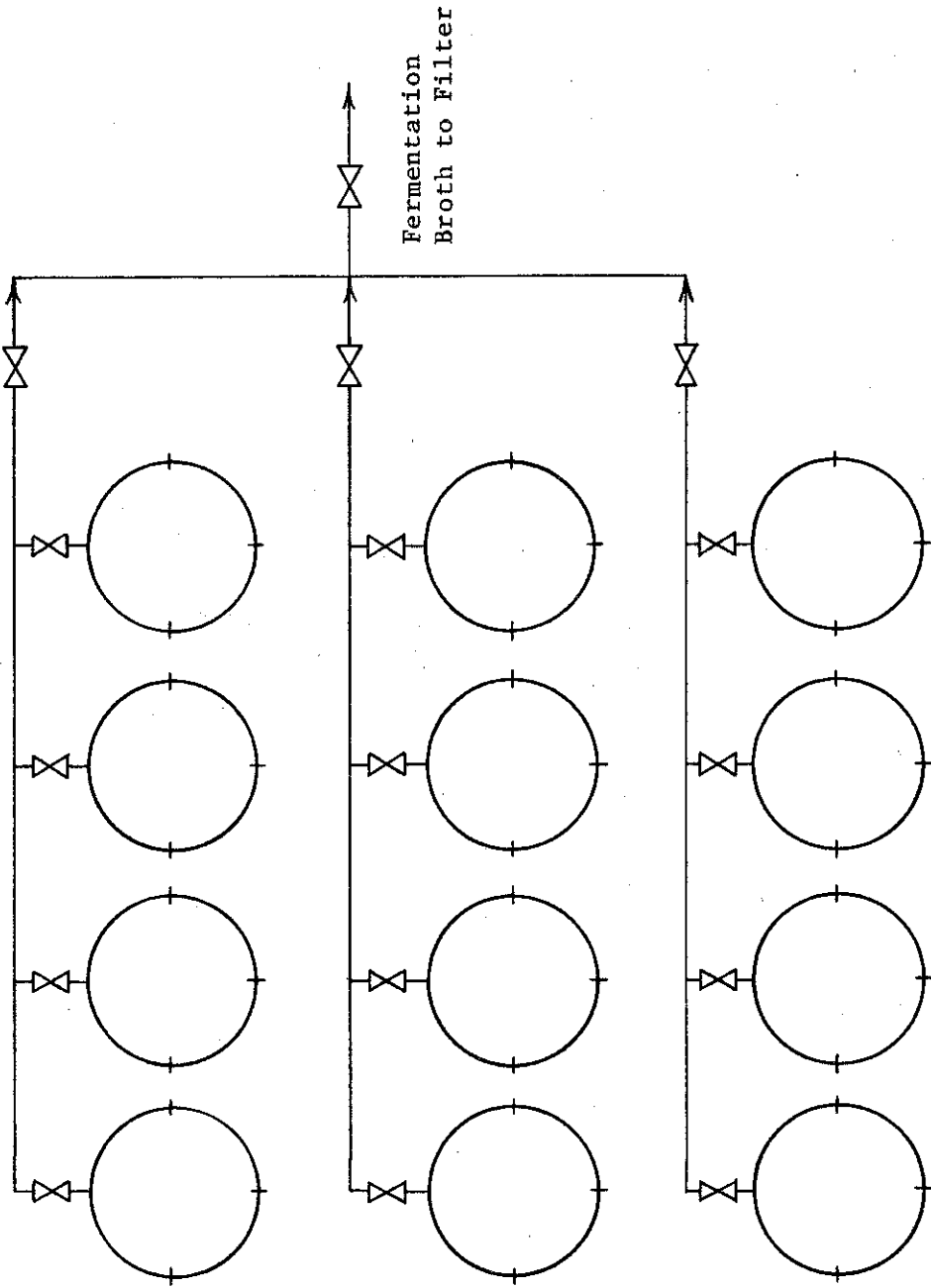

Figure 3: LAY-OUT OF THE FERMENTATION AREA FOR THE PRODUCTION OF PURIFIED BOVINE GROWTH HORMONE



- 12 fermenters: 3 lines with 4 fermenters each

- 75,000 l/fermenter

Figure 4: SCHEMATICS OF GEL-FILTRATION CHROMATOGRAPHY COLUMNS FOR FINAL PURIFICATION OF BOVINE GROWTH HORMONE

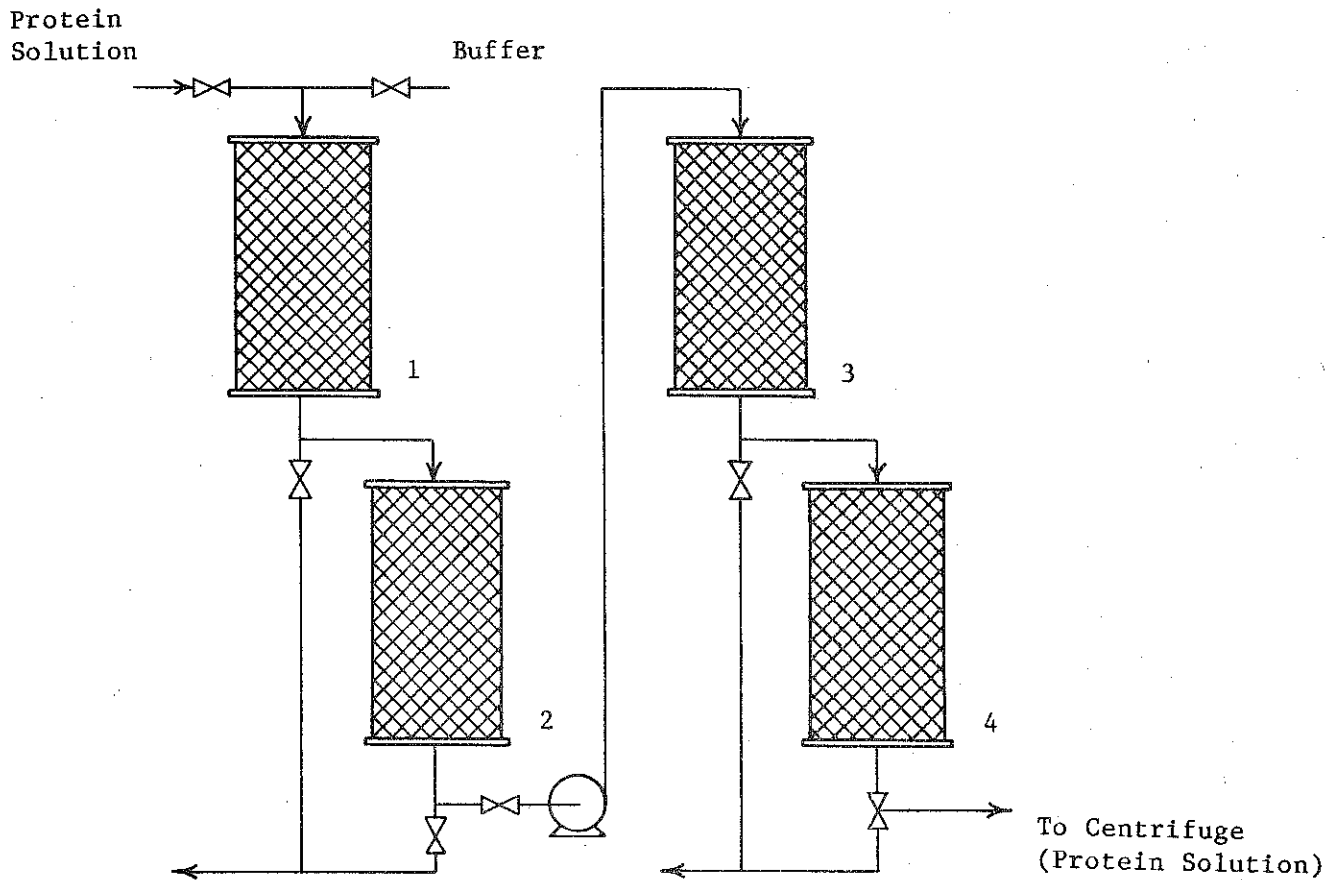

4 Parallel Units, 4 columns each

second and fourth column. A vessel containing buffers is maintained above each column set to provide occasional washings of the agarose. The pumps used at this step are 1 gal/min stainless steel positive displacement.

The bGH fraction is treated with ammonium sulfate and spun in a basket centrifuge. The precipitate can be resuspended in 25mM NaHCO₃ - 25mM Na₂CO₃ for packaging in vials as liquid or the product can be lyophilized and distributed as "freeze-dried" solid. Packaging and formulation will depend on consumer preferences and chosen delivery systems.

PLANT CAPITAL AND OPERATING COSTS

An economic analysis of bGH production feasibility must utilize information on production costs in conjunction with technical, logistical and scale alternatives. However, little comprehensive data, either historical or current, is available from which forecasts of these costs can be derived.

Economists normally classify the costs of any process as either fixed or variable. Fixed (or capital) costs cover the private sector's obligations for resources to provide a given capacity. They do not vary with the level of output once that capacity is installed. Variable (or operating) costs, on the other hand, change with the level of output and can be eliminated by a cessation of production. Although both can occur at various points in the lifetime of an active plant, the distinction is a necessary one if the concepts of marginal analysis are to be applied.²

Capital Cost

As noted above, capital investment estimates are derived using the percentage of delivered-equipment cost technique. This approach required identification of the delivered cost of process equipment and, then, the multiplication of total delivered-equipment cost by a series of percentages to estimate various aspects of installation and construction costs.

Major equipment. Identification of major equipment is a function of engineering design. Major equipment is held to be boilers, heat exchangers, process vessels, pumps and drivers, compression systems, and on-site tankage and storage (Guthrie, p. 117). For this study, costing of these equipment items is done using procedures found in Peters and Timmerhaus (1980) and from manufacturers' quotes. Peters and Timmerhaus is a widely used source book on process plant economics in which equipment pricing is carried out using on cost curves that reflect specific design

²It is also conventional, in economic analysis, to use cost curves defined on a per unit of output basis, rather than on the basis of total costs. Although the same information is utilized, per unit values are analytically preferred.

specifications and materials of construction. In general, this source was used to price all major pieces of equipment except the fermentor vessels and the cell rupture devices which were costed from manufacturers' quotes.

Process equipment costs, as specified in Peters and Timmerhaus, are as of January 1, 1979. Fermentor prices were as of 1980. Thus, in both cases, an inflation factor is used to approximate 1st quarter 1983 prices.³ Based upon these techniques, Appendices A thru L detail equipment costs for plant scales ranging from 0.5 to 7.0 million cow doses of annual capacity. All cost sources provided f.o.b. prices. For delivered cost, a five percent freight charge was added and is reflected in the Appendices values (Guthrie pp. 118-119).

Total capital costs. The second step in plant capital estimation is to scale-up delivered-equipment costs by a factor or series of factors reflecting various other direct and indirect costs of installation and plant construction. Guthrie's approach to cost scale-up requires a more detailed exposition of plant layout and design than is attempted in this study. Peters and Timmerhaus, however, provide a table of factors that may be used directly without layout specifications. These factors, for fluid processing chemical plants, are provided in Table 1. As a fermentation process is typical of a fluid processing plant, these percentages are employed in this study (Peters and Timmerhaus p. 171).

It should be noted that the discounted cash flow model, to be used later, is designed to internally consider working capital and contingency costs. Thus, these costs are excluded in initial plant cost estimation. Also, Peters and Timmerhaus note that construction of a plant at a completely undeveloped site may cost as much as 100 percent more than those estimated using Table 1. For the purposes of this study, it is assumed that construction occurs on a site that has adequate existing infrastructure to qualify for developed site status.

Use of the 4.41 scale-up factor appears appropriate with respect to the bulk of equipment costs displayed in Appendices A thru L. Table 2 summarizes the above discussion on capital cost development for each plant type. Total costs are provided both in terms of the whole plant and on a per unit of annual capacity basis to facilitate cross plant comparisons.

Operating Costs

Operating costs are usually calculated on an annual basis for an entire plant and, then, converted (displayed) on a per unit of product

³The Marshall Swift Plant Cost Index was used in conjunction with the Peters and Timmerhaus estimates. In each case, equipment cost is inflated as follows:

$$\text{Present Cost} = \text{Original Cost} \cdot \frac{\text{Index value at present time}}{\text{Index value at time of original cost}}$$

Table 1

RATIO FACTORS FOR ESTIMATING CAPITAL INVESTMENT ITEMS BASED ON DELIVERED
EQUIPMENT COST^a

Item	Percent of delivered-equipment cost for fluid-processing plant	
Purchased equipment-delivered	100	
Purchased equipment installation	47	
Instrumentation and controls (installed)	18	
Piping (installed)	66	
Electrical (installed)	11	
Buildings (including services)	18	
Yard improvements	10	
Service facilities (installed)	70	
Land	6	
<u>Total direct plant cost</u>	<u>346</u>	<u>346</u>
Engineering and supervision	33	
Construction expenses	41	
	<u>74</u>	<u>74</u>
<u>Total direct and indirect plant costs</u>		<u>420</u>
Contractor's fee (about 5% of total direct and indirect plant costs)	21	
	<u>21</u>	<u>21</u>
<u>Total capital investment</u>		<u>441</u>

^aAdapted from Peters and Timmerhaus (p. 180).

basis. Calculation of annual values for an entire plant smoothes seasonal fluctuations and encompasses infrequent but large expenses. Table 3 identifies typical variable or operating cost categories applicable to a fermentation facility. This list is used to structure an operating cost estimation procedure for the plants designed for this study.⁴ The result of this analysis, for each plant design developed, can be found in Appendices M thru X. The remainder of this section briefly discusses the rationale for each estimate.

⁴Note that several factors often identified as being components of annual costs are not included in Table 3. Factors like depreciation are, in reality, issues of taxation which relate to capital costs and are included directly in the discounted cash flow model developed later. Likewise, financing costs and contingencies are considered directly in exercising the DCF model.

Table 2
PLANT CAPITAL COSTS

Cost Item	0.5 Million Cow Daily Capacity	1.0 Million Cow Daily Capacity	2.5 Million Cow Daily Capacity	3.0 Million Cow Daily Capacity	3.5 Million Cow Daily Capacity	4.0 Million Cow Daily Capacity	4.5 Million Cow Daily Capacity	5.0 Million Cow Daily Capacity	5.5 Million Cow Daily Capacity	6.0 Million Cow Daily Capacity	6.5 Million Cow Daily Capacity	7.0 Million Cow Daily Capacity
Equipment Cost F.O.B.	3,493,017	6,478,723	13,687,801	14,991,765	15,656,821	18,543,886	22,569,958	23,744,023	28,838,376	30,246,067	31,679,294	36,294,202
Delivered (F.O.B. x 1.05)	3,667,668	6,802,659	14,372,191	15,741,353	16,439,662	19,471,080	23,698,456	24,951,224	30,280,295	31,758,370	33,263,259	38,108,912
Total Capital invest- ment Cost (Equipment times 4.41 Cost)	16,174,416	29,999,726	63,381,362	69,419,367	72,498,909	85,867,463	104,510,191	109,946,698	133,536,101	140,054,412	146,690,972	168,060,302
Plant Cost/Gram of Annual Capacity	3.27	3.03	2.56	2.34	2.09	2.17	2.35	2.22	2.45	2.36	2.28	2.43

Table 3

TYPICAL OPERATING COST CATEGORIES^a

Direct Production Costs	Plant Overhead	Administrative Expenses	Distribution and Marketing Expenses
Raw materials	Medical	Executive salaries	Sales Office
Operating labor	Safety and protection	Clerical wages	Salesman expenses
Operating Supervision	Payroll overhead	Engineering and legal costs	Shipping
Electricity	Plant superintendence	Office maintenance	Advertising
Fuel	Packaging	Communications	Technical sales service
Water	Storage facilities		
Maintenance and repairs	Salvage		
Operating supplies	General plant overhead		
Laboratory charges	Taxes		
Royalties	Insurance		
	Rent		

^aAdapted from Peters and Timmerhaus (p. 192).

Direct production costs. Direct production costs include raw materials; operating labor and supervision; utilities such as fuel, electricity, and water; maintenance and repairs; operating supplies; laboratory charges; royalties (if any); and catalysts and solvents.

The raw materials consumed are chiefly growth medium and ph balancers. Fermentation nutrients are of considerable expense. Charges for these nutrients were determined from inquiries to chemical suppliers.

Operating labor and supervision, as distinct from administrative and overhead labor, must be present at the plant 24 hours a day, 7 days a week. As there are 8 hours to a shift, and 21 shifts to a week, it is necessary to have 4 work crews. This enables around the clock operation with a minimum of overtime -- here defined as work time in excess of 40 hours per week.⁵ Thus, there are 20 straight time and 1 overtime (time and a half) shifts per week. Following Peters and Timmerhaus, direct labor is assigned on the basis of work to be done (p. 195). Supervision needs are met by supervisors for non-daytime and weekend shifts. Daytime supervision is provided by the quality control manager, whose overall job responsibilities fall under the category of plant overhead. The hourly wage for an operator is currently in the neighborhood of \$10.00/hour (exclusive of a 25 percent fringe package). Wage rates for supervisors are \$14.00 per hour.

Electricity is costed at \$.070 per kwh. Water is assumed pumped from wells, and as pumping charges are incorporated into the cost of electricity, no cost is assigned to water. If water must be taken from a municipal system, of course, a charge should be assigned.

Maintenance and repairs are assumed to be 3 percent of total fixed capital investment (Peters and Timmerhaus, p. 200). Where applicable, operating supplies are packaging, lubricants, chemicals, and custodial supplies, or other materials not considered to be either raw materials or repair and maintenance materials. These are costed at 15 percent of repair and maintenance costs, based on process industry estimates (Peters and Timmerhaus, p. 200). Laboratory charges for most process industries are calculated by estimating employee-hours involved, and multiplying this by the appropriate rate (Peters and Timmerhaus, p. 200). As the process of fermentation is fairly standard, it is assumed one full time chemist at \$16.00 an hour is sufficient for the smaller plant operations -- chiefly yeast culture, and that three full time chemists are required for the larger plants. Patents and royalties are not a cost factor for these designs. Processes used for these plant designs are widely known and do not involve unique technology or machinery.

Plant overhead. Plant overhead costs as defined by Peters and Timmerhaus includes medical, safety and protection, payroll overhead, plant

⁵In all cases, wages are adjusted upwards by \$0.15 per hour for evening shifts and \$0.20 per hour for night shifts.

superintendence, packaging, storage facilities, salvage, control laboratories, and general plant overhead. Local taxes, insurance, and rent are also included. In general, such items as medical and payroll overhead are included in a 25 percent fringe package that is allotted to all plant employees over and above hourly pay or yearly salary. Safety is to be a function of supervision.

Plant superintendence is plant specific and salaried accordingly. labor for packaging of products is costed at \$9.00 per hour with packaging supplies included as part of operating supplies under direct costs. No plant salvage operations are considered.

General plant overhead costs are also constructed to encompass custodial personnel. Maintenance and laboratory costs are covered elsewhere under direct costs. Janitors are paid an hourly wage of \$6.00. Payroll overhead is assumed to be 5 percent of total payroll.

Overhead costs of property tax, insurance, and rent are derived as proportions of total capital investment. Insurance is assumed to be 1 percent of capital investment (Peters and Timmerhaus, p. 202). Property tax is highly variable depending on location, due to the multitude of taxing districts. For areas of relatively low population density, Peters and Timmerhaus suggest a rate of 1 to 2 percent of total investment (p. 202). Here, 1 percent is assumed. As land is to be owned, rent is not a factor.

Administrative expenses. Administration costs for the plant include the charges for administrators, secretaries, accountants, and other main office personnel. Salaries for the general manager and comptroller are plant specific. Secretaries are paid at a basic wage of \$6.00 per hour, while clerks are paid \$8.00 per hour. Other costs, such as engineering and legal, office maintenance, and communications, are here assumed to equal 50 percent of overall administrative labor costs.

Distribution and marketing expenses. Distribution and marketing expenses include the costs of sales office employees, salesman expenses, shipping, advertising, and technical sales service. These services are plant specific.

Summary. Based upon the values detailed in Appendices M thru X, annual operating costs for each plant design are tabulated in Table 4.

ECONOMIC AND FINANCIAL EVALUATION

Given information on the potential plant designs and costs, one can proceed to a comprehensive evaluation of economic and financial feasibility for bGH production facilities. Traditionally, the core of such an evaluation has involved a discounted cash flow analysis of alternative investment opportunities (Aplin and Casler, 1975). If one knew all the potential

Table 4

ANNUAL PLANT OPERATING COSTS

Cost Item	0.5 Million Cow Daily Capacity	1.0 Million Cow Daily Capacity	2.5 Million Cow Daily Capacity	3.0 Million Cow Daily Capacity	3.5 Million Cow Daily Capacity	4.0 Million Cow Daily Capacity	4.5 Million Cow Daily Capacity	5.0 Million Cow Daily Capacity	5.5 Million Cow Daily Capacity	6.0 Million Cow Daily Capacity	6.5 Million Cow Daily Capacity	7.0 Million Cow Daily Capacity
Direct	16,352,248	30,519,147	63,603,926	70,034,333	81,887,805	86,799,506	89,684,740	90,423,679	90,884,057	98,800,200	95,508,014	103,676,216
Overhead	935,972	1,244,232	2,107,708	2,282,942	2,440,079	2,840,440	3,267,168	3,450,536	4,053,704	4,265,201	4,483,479	4,947,030
Administrative	172,860	195,900	284,040	284,040	331,860	337,860	337,860	337,860	397,680	397,680	453,000	453,000
Marketing	82,320	82,320	130,140	135,140	177,960	204,000	204,000	251,820	299,640	299,640	337,680	337,680
Total Operating Cost	17,543,400	32,041,599	66,125,814	72,734,455	84,841,704	90,181,806	93,493,768	94,463,995	95,635,081	103,762,721	100,582,173	109,413,926
Plant Operating Cost/ Gram of Annual Capacity	3.54	3.24	2.67	2.45	2.45	2.28	2.10	1.91	1.76	1.75	1.56	1.58

Source: Appendices M thru X.

plant capital and operating costs, as well as product prices, with certainty for the projected construction and operating time horizon, an economic and financial analysis could be concluded rapidly with little doubt about its reliability. Potential investors could determine which alternative yielded adequate rates of return on equity capital and make appropriate investment decisions in line with individual preferences. However, the uncertainties in key variables impacting future economic events, which are normally present in economic activity, are even more critical in the case of emerging products. Market factors, future public policy decisions (both domestically and internationally), relative rates of inflation and institutional circumstances are all important in this regard. Consequently, any one of a wide range of future outcomes from an investment is possible. Therefore, something more than a single solution to the discounted cash flow model is needed to address the feasibility issue in light of these uncertainties.

For this evaluation, consideration of the most important uncertainties takes place in two ways. First, a discounted cash flow (DCF) analysis is completed for each of a large number of possible real world conditions. That is, while one can make reasonable forecasts of future trends in prices, and capital and operating costs, there can exist over time considerable random variation about these trends. This random variation is captured in the large number of separate runs of the DCF model, through Monte Carlo simulation of possible future values of the important economic variables (Meier *et al.*, 1969). An analysis of these results provides not only the expected outcome of a given course of action (investment decision), but also the range and potential variability of these results.

Second, the model is used to study the sensitivity of future outcomes to other important assumptions or factors that are not subject to random variation and, therefore, cannot be accommodated in a "Monte Carlo" experiment. These factors include certain entrepreneurial decisions such as required rates of return and desired debt/equity ratios that affect a plant's costs or revenues. Some cyclical or other systematic price changes may also be analyzed in this fashion.

The remainder of this section is used to provide a brief description of the DCF model and to present the results of the Monte Carlo simulation and sensitivity analyses for each of the alternative plant designs discussed above. For each investment alternative, the commercial feasibility of plant construction and operation are analyzed within the context of:

- o The present value of after tax net revenue;
- o The breakeven price to produce bGH assuming different rates of return on equity capital;
- o The probability of incurring a loss; and
- o The potential variability in net return.

The Model

Throughout the economics literature, it is often assumed that production and investment decisions are made with perfect knowledge about the future and are based on a desire to maximize the present value of future net revenues (Henderson and Quandt, 1974). Variations on this decision rule, particularly in the face of uncertainty, have been proposed but they all rely to a greater or lesser degree on the discounted cash flow method. Therefore, the major component of the investment model employed here is an algorithm to calculate the present value of net (after tax) revenue, given an initial investment in a bGH production facility and a known production period. The model can either calculate the net revenue values using forecast market prices for the product or determine the minimum market price that would provide a positive net return. The later approach appears most appropriate for a new product with no established price history and is used initially in the following analysis. The essential components of the DCF model are given in Figure 5. A more technical explanation can be found in Kalter et al. (1983).

Data and Assumptions

The DCF analyses for each of the twelve plant scales are based upon the cost and production data developed, and a number of assumptions concerning key economic and institutional variables. Table 2 displays the capital required per unit of installed annual capacity for each plant scale. Table 4 contains the associated operating costs for the initial production time period.

For each of the plant sizes developed, a "reference case" DCF analysis is conducted. The "reference cases" use the costs contained in Tables 2 and 4 and a series of common assumptions concerning other key variables which would be generally accepted as representative of current values, forecasts or practice (as the case may be). The results of these "reference cases" will be used as a standard of comparison for the sensitivity analyses to be conducted. Table 5 displays these common variables and the values to be used. Categories defined include cost related input variables, plant production time frames, and economic and tax related variables.

Cost Related Inputs. The first items in Table 5 include the annual rate of change in operating costs and the working capital factor, and, for the Monte Carlo analysis, the investment and operating cost contingency distributions. The investment cost contingency is a method of addressing expected cost overruns in plant construction. In recent years, the rate of inflation for construction costs has exceeded the general rate of inflation. General convention holds that a contingency factor of 10 percent above estimated plant direct and indirect capital costs be employed to approximate this circumstance (Peters and Timmerhaus, 1980). However, substantial variation above and below this figure is possible. Thus, the contingency specified for the "reference cases" encompasses a range in capital

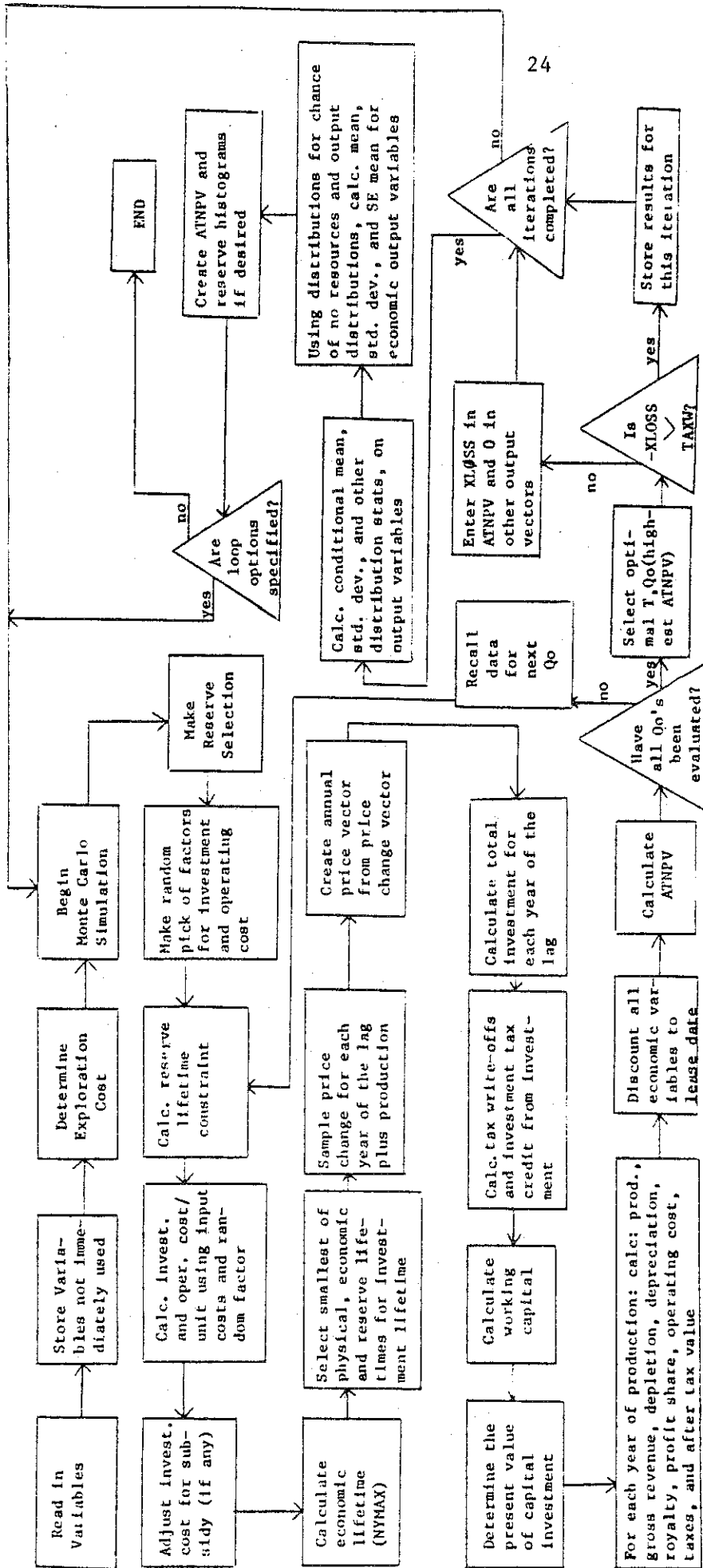

Figure 5: FLOW DIAGRAM FOR SIMULATION MODEL WITH INPUT Q0

Q0 = installed annual capacity
 ATNPV = after-tax net present value
 TAXW = tax write-off available if lease is not developed after exploration
 XLOSS = loss incurred from exploration if lease is not developed (exclusive of bonus)

Table 5

PRINCIPLE ECONOMIC, INSTITUTIONAL AND POLICY ASSUMPTIONS FOR
"REFERENCE CASE" DCF ANALYSES

Item	Value
<u>Cost Related Inputs</u>	
Investment Cost Contingency Distribution	
Minimum	+5 percent
Maximum	+20 percent
Most likely	+10 percent
Operating Cost Contingency Distribution	
Minimum	-10 percent
Maximum	+10 percent
Most likely	0 percent
Operating Cost Annual Real Rate of Change	2 percent
Working Capital Factor	10 percent of annual operating costs
<u>Planning Horizon</u>	
Length of Plant Construction Period	3 years
Length of Plant Production	20 years
<u>Economic and Tax Values</u>	
Discount Rate (after tax real return on equity)	10 percent
Loan Interest Rate (before tax real; nominal before tax equals 12 percent)	6.67 percent
Debt-Equity Ratio	75/25
Depreciation	
Method	ACRS
Lifetime	10 years
Rate of Inflation	5 percent
Federal Tax Credits	
Investment Tax Credit for Equipment	10 percent
Tax Rates	
Federal	46 percent
State	4 percent

costs from 5 to 20 percent above those estimated previously, with the most likely value being 10 percent in excess of estimates values. See Kalter et al. (1983) for details concerning the use of these values in a Monte Carlo analysis.

Operating costs are also uncertain; but the uncertainty often results from substantial short-term variations in the cost of key inputs due to shortages. For the DCF analysis, operating costs are allowed to vary randomly within the bounds of plus or minus 10 percent of the cost specified. In addition, an annual real increase in operating costs is expected. It was assumed that this increase would equal two percent, compounded annually. Short-term uncertainty is reflected as random fluctuations about this trend.

Working capital, required to finance on-going plant operations, is usually considered separately from basic investment outlays. Working capital needs vary with inventory prices and the maturity of accounts payable and receivable. A variety of approaches may be used to estimate working capital requirements. For purposes of a feasibility analysis, a standard technique is to use a fixed percentage of total operating costs. Where substantial quantities of product must be carried in inventory for long periods of time, this factor may be as high as 20 percent. Given the low inventory requirements involved here, a 10 percent factor was assumed for this study.

Planning Horizon. The selection of both a plant construction period and the plant's useful life is important in DCF analysis because of the time value of money. The expected useful life of a chemical processing unit is generally estimated to be 20 years (Peters and Timmerhaus, 1980). This assumption is used below for most of the evaluations undertaken. The production period is, however, subjected to sensitivity analysis. Industry sources project the construction period for fermentation facilities to be approximately three years and that estimate is used throughout the analysis. It is further assumed that the total capital expenditures during those years are distributed over time at the rate of 30, 50 and 20 percent, respectively.

Economic and Tax Values. A number of institutional considerations and other economic factors delineate the financial environment within which an investment analysis must take place. These factors include the real discount rate, the debt-equity ratio, the cost of borrowing, the method of depreciation, the underlying rate of inflation, federal tax credits, and federal and state tax rates.

The discount rate is of course the crux of a discounted cash flow analysis. The purpose of the discount rate is to measure the present value of income earned over time. In everyday use, the discount rate is generally given in nominal terms, accounting for both inflation, which erodes the value of future dollars, and the opportunity cost of the dollar invested. However, the DCF calculations reported below are derived

assuming the absence of inflation (that is, all dollar figures are stated in terms of 1983 values). This necessitates the use of a "real" interest rate for discounting to reflect the "real" opportunity cost of a dollar invested.

In addition, investment decisions are normally made by considering the after-tax cost of capital. Since the cost of capital is composed of the required rate of return on equity capital and the cost of debt capital, a weighted average after-tax value is used as the discount rate for all the plant evaluations discussed below. The formula for calculating the real weighted average after-tax cost of capital is:

$$r^* = e^*u + (1-u)(1 - \phi + t - \tau)d'^*$$

when e^* is the required after tax real rate of return on equity capital, u is the proportion of investment capital from equity, ϕ is the marginal federal tax rate and d'^* is the pretax real rate of interest on debt capital.

The rate of return required on equity capital can vary widely depending on the individual investor. In general, it should equal the rate of return obtainable from investments of comparable risk. For purposes of a general feasibility study, a rate should be used which closely approximates that generally acceptable to the industry in question. Often this must be based on the analyst's best judgement after discussions with industry representatives. For this study, a 10 percent rate is assumed for the "reference case" analyses. Assuming an annual inflation rate of 5 percent, this translates to a 15.5 percent nominal rate of return on investment.⁶ Due to the subjective nature of this value, it also is the subject of sensitivity analysis at a later point.

The cost of debt capital can also vary widely depending upon the individual investor's credit rating and the specific terms applicable to a given loan. It was assumed that a 6.6 percent before tax real rate of interest would best characterize current lending conditions for this type of facility and would be applicable over the life of the financing package. At a five percent rate of inflation, such a rate translates to a 12 percent nominal market cost of debt capital (a value close to current market conditions experienced by large, credit-worthy borrowers).

The debt-equity ratio selected also has a marked impact on the DCF analysis due to the nature of financial leverage. Actual debt-equity

⁶The real discount rate is determined by discounting a dollar invested at the nominal rate by the rate of inflation over one period. That is:

$$\frac{1 + r}{1 - i} - 1 = R$$

where r equals the nominal discount rate, i equals the inflation rate and R equals the real discount rate. Conversely, solving for the nominal discount rate, one obtains $r = (1 + i)(1 + R) - 1$ (Howe, 1971).

ratios are highly individualistic to the particular investment, and investor. For the "reference case" it is convenient to assume a 75/25 debt-equity ratio.⁷ During the sensitivity analysis, the implications of this assumption are examined.

Rapid depreciation of capital investment is a tax strategy which maximizes after tax net present value. Currently, accelerated depreciation is permitted by the Accelerated Cost Recovery System of the United States tax code. This technique is used below, for the "reference cases" and throughout the remainder of the analysis, by assuming a 10 year depreciation period (the most rapid now permitted). The salvage value of depreciable investment is not considered when using ACRS methods.

As discussed above, "real" costs and prices are used throughout this analysis. However, an assumed rate of inflation must also be specified for use in the model in order that the tax deductions stemming from depreciation calculations can be adjusted (in practice, the depreciation schedule is developed in nominal terms and an analysis carried out in "real" values must compensate for this fact). Reflecting the experience of recent years, the overall annual rate of inflation for this analysis is assumed to be 5 percent. Small variations in this rate will have little consequence for the present value calculations.

Federal tax credits consist of an investment tax credit of 10 percent. Tax rates are categorized into federal, state, and local. Local taxes are assumed to be on property, at a 1 percent of plant capital value annual rate, and were included in the operating costs determined above for individual scales. Federal taxes are assumed assessed at the current nominal rate of 46 percent on taxable earnings in excess of \$100,000. State corporation franchise (income) tax rate formulas are complicated and often depend on the state and the financial structure of the taxed firm. Therefore, it is assumed that a rate of 4 percent is assessed on the taxable income of the average firm involved in bGH production.

RESULTS

Table 6 summarizes the results of the discounted cash flow analysis for each of the "reference cases." Appendix Y provides the detailed cash flows for each of these cases. The values contained in Table 6 are the necessary wholesale market price for the product to obtain the stipulated cost of capital. Under the "reference case" assumptions, the necessary wholesale market prices range from \$4.23 per gram of bGH for the one half million cow daily capacity plant to \$1.93 for the 6.5 million cow daily capacity facility (\$0.186 to \$0.085 per daily dose per cow).⁸

⁷An implicit assumption is that the debt-equity ratio will remain constant over time as a result of an overall corporate financial phase.

⁸Although the required price rose slightly for the 7.0 million cow facility, this was probably due to lumpiness in the capital costs and not to the exhaustion of scale economies.

Table 6

PRICE TO PRODUCE REQUIRED FOR ECONOMIC FEASIBILITY^a

Plant Capacity in Cow Doses Per Day	Price Per bGH Gram	Probability of a Positive After Tax Net Present Value
0.5 Million	\$4.23	98%
1.0 Million	\$3.81	95%
2.5 Million	\$3.17	95%
3.0 Million	\$2.91	95%
3.5 Million	\$2.89	97%
4.0 Million	\$2.71	96%
4.5 Million	\$2.53	95%
5.0 Million	\$2.31	95%
5.5 Million	\$2.17	95%
6.0 Million	\$2.15	95%
6.5 Million	\$1.93	95%
7.0 Million	\$1.97	95%

^aResults are based on 100 Monte Carlo iterations. The price values should be interpreted as the required constant wholesale price, over 20 years of production, necessary to obtain a 10 percent real, after-tax rate of return on equity capital and to pay a 6.67 percent real, before-tax rate of interest on debt capital with a 75/25 debt-equity ratio. Values do not include formulation, marketing costs or above normal profits and, therefore, should not be considered selling prices.

For all the "reference cases," 100 Monte Carlo iterations were utilized in conjunction with the assumptions given in Table 5. The resulting price to produce is clearly related to plant size indicating that substantial economies of scale exist between the smallest scale facility analyzed and plants with a daily cow capacity of 6.5 million. The expected market price values were derived on the basis of an assured 95+ percent probability that the ATNPV would be positive in view of the uncertainties involved. Thus, over the 100 Monte Carlo iterations (each iteration representing a different set of potential real world capital and operating costs), ATNPV could not be negative more than 5 percent of the time for the reference cases tested.

However, it is important to note that selling prices for the hormone will be higher than production costs due to marketing costs, mark-ups through the distribution chain and, perhaps most importantly, the cost of hormone purification and enhancement. For example, use of implant devices for deliveries, rather than daily injection, could substantially raise the selling price.

Sensitivity Analysis

In defining the "reference cases," several key assumptions were made with respect to the plant time horizon, the required rate of return on equity capital, the commercial loan rate and the debt/equity ratio. The purpose of this subsection is to determine the sensitivity of the reference case results to these assumptions. From such an analysis, changes resulting from alternative assumptions can be established.

Table 7 contains the results of these evaluations. The specific variables tested, and the range of values used for each, is listed in the Table stub. For each plant capacity, the "reference case" price to produce (Table 6) are used as the basis for the analysis and the variation in ATNPV and the probability of a loss are noted.

First, sensitivity with respect to the production time horizon is tested. Although a production time horizon of 20 years is often assumed for new facilities, many potential investors may demand a shorter payback period. This is particularly true in light of the rapidly changing technology involved in the biotechnology arena. Thus, time horizons of 15, 10 and 5 years are considered.

As expected, after tax net present value falls and the probability of a loss rises as production time horizons are shortened. However, a 15, rather than 20, year period increases the probability of a loss only 6 to 17 points (depending on the plant size) while a positive ATNPV is maintained. For a production time horizon of ten years, after tax net present value remains positive but the probability of a loss increases to a range of 36 to 74 percent (increasing with plant size). For a five year time horizon, after tax net present value is negative for all plant sizes above 4.5 million cows per day and the probability of a loss is above 85 percent in all cases. However, even with the five year production assumption, a 25 cent per gram price increase (one cent per cow dose) reduces the probability of a loss to the range of 45 to 55 percent, while a 50 cent per gram increase in price (2 cents per cow dose) reduces the probability of loss to zero. Plant profitability is thus highly sensitive to minor absolute changes in dosage price although the percentage change in price may be substantial.

Four major elements impact the cost of capital used in the analysis. They include the required return on equity capital, loan interest rates, the debt/equity ratio, and the rate of inflation.⁹ Of these, sensitivity

⁹Although the analysis is carried out in real terms, the conversion of the debt capital rate from a before to an after tax value requires conversion of the provided values to nominal terms so that they can be utilized with the appropriate tax rates (which are nominal values). Thus, the assumed rate of inflation must be used to initially convert the real before tax values to nominal before tax values and then to reconvert the weighted average nominal after tax values to real after tax values.

Table 7

RESULTS OF SENSITIVITY ANALYSIS^a

Cost Item	0.5 Million Cow Daily Capacity	1.0 Million Cow Daily Capacity	2.5 Million Cow Daily Capacity	3.0 Million Cow Daily Capacity	3.5 Million Cow Daily Capacity	4.0 Million Cow Daily Capacity
Reference Assumptions	10.48 (5.41) (2%)	16.86 (9.79) (5%)	34.67 (20.19) (95%)	38.51 (22.23) (5%)	46.05 (25.94) (3%)	48.49 (27.63) (4%)
Sensitivity Assumptions ^b						
Production Time Horizon						
15 years	6.46 (4.22) (6%)	10.05 (7.41) (14%)	20.47 (15.24) (14%)	22.82 (16.82) (14%)	28.49 (19.93) (11%)	28.87 (20.90) (12%)
10 years	2.19 (2.29) (36%)	3.10 (3.66) (45%)	6.10 (7.36) (55%)	6.89 (8.21) (45%)	9.95 (10.74) (36%)	8.85 (10.39) (45%)
5 years	0.05 (0.18) (89%)	0.03 (0.15) (96%)	0.03 (0.21) (96%)	0.05 (0.27) (96%)	0.32 (1.04) (85%)	0.07 (0.39) (96%)
Debt/Equity Ratio						
50/50	5.37 (3.95) (14%)	8.20 (6.83) (19%)	16.63 (14.02) (79%)	18.59 (15.50) (11%)	23.64 (18.55) (16%)	23.57 (19.37) (18%)
25/75	2.23 (2.41) (36%)	3.15 (3.82) (45%)	6.20 (7.69) (47%)	7.00 (8.58) (45%)	9.96 (11.21) (39%)	8.99 (10.85) (45%)
Real Return on Equity						
5% (after tax)	14.38 (6.34) (1%)	23.64 (11.51) (2%)	48.81 (23.76) (2%)	54.10 (26.13) (2%)	63.39 (30.41) (2%)	67.92 (32.46) (2%)
15% (after tax)	7.33 (4.59) (6%)	11.49 (8.11) (11%)	23.47 (16.70) (11%)	26.15 (18.42) (11%)	32.20 (21.73) (10%)	33.04 (22.96) (11%)
Loan Interest Rates (real)						
9.5% (before tax)	7.67 (4.68) (6%)	12.06 (8.31) (11%)	24.66 (17.12) (11%)	27.46 (18.87) (11%)	33.68 (22.23) (8%)	34.68 (23.52) (10%)
3.8% (before tax)	13.92 (6.24) (1%)	22.83 (11.31) (2%)	47.13 (23.35) (2%)	52.25 (25.68) (2%)	61.34 (29.89) (2%)	65.62 (31.89) (2%)

Table 7 (Cont.)
RESULTS OF SENSITIVITY ANALYSIS^a

Cost Item	4.5 Million Cow Daily Capacity	5.0 Million Cow Daily Capacity	5.5 Million Cow Daily Capacity	6.0 Million Cow Daily Capacity	6.5 Million Cow Daily Capacity	7.0 Million Cow Daily Capacity
Reference						
Assumptions	49.72 (28.61) (5%)	50.41 (28.94) (5%)	51.20 (29.37) (5%)	55.56 (31.86) (5%)	51.77 (30.61) (5%)	57.81 (33.52) (5%)
Sensitivity Assumptions^b						
Production Time Horizon						
15 Years	27.75 (21.50) (15%)	27.67 (21.45) (15%)	25.68 (21.17) (17%)	28.37 (23.09) (17%)	24.89 (21.59) (23%)	27.17 (23.57) (22%)
10 Years	6.61 (8.91) (52%)	6.17 (8.59) (53%)	3.62 (6.31) (64%)	4.42 (7.34) (61%)	2.77 (5.45) (70%)	2.57 (5.37) (74%)
5 Years	ND (100%)	ND (100%)	ND (100%)	ND (100%)	ND (100%)	ND (100%)
Debt/Equity Ratio						
50/50	22.06 (19.35) (23%)	21.87 (19.42) (23%)	19.59 (18.67) (31%)	21.78 (20.50) (29%)	18.70 (18.68) (33%)	20.23 (20.50) (33%)
25/75	6.88 (9.43) (52%)	6.46 (9.12) (54%)	4.00 (6.92) (63%)	4.83 (7.99) (61%)	3.14 (6.07) (70%)	2.99 (6.09) (72%)
Real Return on Equity						
5% (after tax)	71.61 (33.71) (2%)	73.05 (34.11) (2%)	76.78 (34.71) (1%)	82.77 (37.63) (1%)	79.02 (36.34) (1%)	88.81 (39.71) (1%)
15% (after tax)	34.43 (23.49) (12%)	32.55 (23.70) (12%)	31.16 (23.68) (15%)	34.21 (25.76) (14%)	30.63 (24.32) (17%)	33.74 (26.62) (17%)
Loan Interest Rates (Real)						
9.5% (before tax)	34.27 (24.10) (11%)	34.44 (24.33) (11%)	33.25 (24.40) (13%)	36.45 (26.53) (12%)	32.81 (25.15) (15%)	36.22 (27.53) (15%)
3.8% (before tax)	69.02 (33.12) (2%)	70.56 (33.50) (2%)	73.74 (34.11) (2%)	79.54 (36.97) (2%)	75.78 (35.68) (2%)	85.12 (39.03) (1%)

^aData in the Table are based on 100 Monte Carlo iterations. Mean values after tax net present values are shown with standard deviations given in the first set of parentheses and the probability of a loss in the second. All dollar values are in millions.

^bThe sensitivity results embody the reference case assumption, except for the item noted in the stub.

testing was performed on the first three. As the results given in Table 7 show, only increasing the equity component of capital investment to 75 per cent had a major impact on profitability. Throughout the analysis, the ATNPV is assumed to be the present value of net revenues in excess of the stipulated rate of return on invested capital. Therefore, as the amount of equity capital committed rises, ATNPV tends to fall since the return on equity capital is higher than that for the debt component. Again, a 25 cent per gram increase in selling price was sufficient (for all plants) to reduce the probability of loss to zero.

Probability of Commercial Success

In light of the production costs per bGH gram given above, a tentative evaluation of bGH's commercial viability can be undertaken. However, to sustain a cow receiving bGH, more feed will be required and hence higher feed costs will result. The question of a balanced ration and the associated cost is the subject of the next section. However, assume for sake of argument that the extra feed costs for an additional pound of milk induced by bGH will average between 5 and 8 cents. If one conservatively assumes that bGH will stimulate an additional eight pounds of milk per cow daily, Table 8 details the extra daily milk revenue to be expected at various market prices per hundred weight. Also shown is the range of possible additional feed expenditures per cow per day and the residual revenue available to purchase bGH, pay for its administration, cover any other additional costs, and increase farm profit.

Table 8

PRELIMINARY EVALUATION OF bGH COMMERCIAL VIABILITY GIVEN ALTERNATIVE MILK PRICES AND FEED COSTS

Milk Price	Additional Gross Revenue/Day (assuming 8#/day production increase)	Range of Additional Feed Costs	Residue
\$13.50	\$1.08	\$.40-.64	\$.68-.44
\$12.50	\$1.00	\$.40-.64	\$.60-.36
\$11.50	\$.92	\$.40-.64	\$.52-.28
\$10.50	\$.84	\$.40-.64	\$.44-.20
\$9.50	\$.76	\$.40-.64	\$.36-.12
\$8.50	\$.68	\$.40-.64	\$.28-.04
\$7.50	\$.60	\$.40-.64	\$.20-(-.04)

Additional feed costs and the extent of improvement in milk production are clearly vital variables in determining the incentive to use bGH. However, even if farm milk prices deteriorated sharply, a substantial incentive would exist for adoption at bGH prices ranging from two to four times raw production costs, especially when the marginal feed costs can be contained near the lower end of the range shown. Of perhaps equal importance, several additional pounds of milk production per cow would be all that is required to make bGH profitable with higher feed prices and an on-farm milk price as low as \$9.50 per hundred weight. Of course, if one had higher feed prices and the value of milk fell below \$9.50/cwt, it would not be profitable to produce milk regardless of whether bGH was utilized.

Several other factors are important to understanding the market potential of bGH. First, substantial scale economies appear to exist with respect to production. This suggests that a single large manufacturing facility is economically preferred if market monopolization is not a factor. Conversely, it implies that monopoly power could develop with the resultant effect being bGH market prices substantially higher than production, marketing and delivery costs. The impact on farm profitability, adoption rates and, ultimately, on milk markets is unknown (depending on the amount of economic rent that the conferred market power would permit the firm to extract.)

Another factor potentially impacting the market price of bGH relates to the technical issue of fermentation yield from the industrial production process. The above evaluation assumed a product yield of 0.09g per liter based on 10^5 molecules of product per cell and a 50 percent loss due to scale-up. This is based upon the use of a relatively inefficient transcription plasmid (e.g., pBR322). Use of the pTAC vector could improve the efficiency more than ten times. If improved yields could be obtained and engineering problems involved in a scale-up (such as incomplete mixing and higher temperature due to heat generation) could be solved, the production costs of the product would be substantially reduced.

Finally another factor impacting bGH market potential involves the daily dose and resulting increases in milk production. Thus far, bGH effects have not been examined under the wide range of environmental conditions and animal management schemes which would exist on commercial dairy farms. The preceding calculations assumed a daily dose of 44 mg/cow and an increase in milk production of 8 lb/day. Bauman and coworkers (1985) recently completed a long term study utilizing different doses of recombinant bGH. They observed that 27 mg/day was as effective as 40.5 mg/day bGH with average increases in milk yield equal to 25 lb/cow/day.

In summary, although important to the ultimate market price of bGH, the sensitivity of production plant economics to changes in technical coefficients or economic assumptions will not be the only factor determining the ultimate economic success of bGH. The marginal costs of additional feed requirements, the associated increase in daily milk production and the equilibrium price of milk appear to be equally important considerations in determining farm adoption rates and economic impacts.

Section III

THE ECONOMIC IMPLICATIONS OF bGH FOR FEED REQUIREMENTS, CROP ROTATIONS AND FARM PROFITABILITY

The rate of bGH adoption by individual dairy farm managers will depend on a number of factors in addition to product cost. The potential response in productivity, ease of inclusion in overall herd management, and actual response under a variety of management situations will contribute to profitability and extent of usage. This section seeks to provide a basis for analyzing the "macro" implications of bGH by evaluating the potential impact on dairy production at the "micro" or farm level.

Potential profitability of using bGH is investigated by analysis of three representative dairy farms. These three farms are constructed to represent the broad diversity of resources available to dairy farm managers in New York State, the Northeast, and the Lakes States. The resources on these representative farms, cost and return information from enterprise budgets, and milk production and feed requirements with and without bGH are used to obtain profit maximizing enterprise levels using linear programming (LP). Results from LP runs without bGH and with several bGH response rates are used to analyze farm firm level issues including:

- o What is the potential effect of bGH adoption on profitability for each of the representative farms?
- o How does the profitability of adoption vary with assumptions on feed intake response of the dairy cow?
- o Is there a significant difference in the profitability of using bGH among the representative farms?
- o What is the impact of bGH adoption on present crop rotation patterns?
- o How does the impact on crop rotation patterns depend on the characteristics of the farms and/or the assumption on feed intake response?
- o What happens to farm profitability as milk price is reduced?

REPRESENTATIVE FARMS

In an effort to simplify the analysis and to concentrate on the relative impacts of bGH, farms representing various resource levels within a region were configured. For purposes of this analysis, New York State data were used in determining the level of key characteristics for these farms. The resulting representative farms are thought to emulate much of the dairy farming activity in the Northeast and Lake States, although the proportion of total production represented by any one representation will differ on a state by state basis.

After reviewing the available data (Cornell Dairy Farm Business Summary Data Tapes)¹, three farms types were chosen to represent the spectrum of dairy activity in the region. The three farm types are (1) farms growing only forage crops, (2) farms growing some but not all of their required grain, and (3) farms with excess grain to sell as a cash crop. Data from the Dairy Farm Business Summary records were grouped using these categories to obtain averages and ranges of resource and productivity characteristics.² Table 9 outlines the general characteristics of the three representative farms. Since milk production per cow is highly variable and crucial to the analysis, each representative farm is evaluated at 13,000 and 16,000 pounds of milk sold per cow.

Representative Farm Characteristics

Table 10 summarizes the detailed characteristics of the three representative farms. The 65 cow farm is intended to characterize small units (200

Table 9

GENERAL CHARACTERISTICS OF REPRESENTATIVE FARMS

Representative Farm	Dairy Herd Size (milking cows)	Hay Crop	Corn Crops
Forage Only	65	Mixed mostly grass hay	Silage
Corn Grain	100	Mixed mostly legume hay	Silage and Grain
Crop Sales	100	Mixed mostly legume hay	Silage and Grain

¹Data summarized in Smith and Putnam (1983).

²The three farm types were obtained using the following criteria:

- o dairy farms with no corn grown to represent forage only;
- o dairy farms with crop sales greater than five percent of milk sales and grain corn acres equal to or greater than 50 percent of corn silage acres to represent grain for sale;
- o the remaining dairy farms to represent some farm grown concentrate.

Table 10
DETAILED CHARACTERISTICS OF REPRESENTATIVE FARMS^a

Representative Farm	Total Cropland (acres)	Maximum Corn Production (acres)	Maximum Corn Grain Production (acres)	Full Time Family Worker Equivalents Available ^b	Hay Yields (tons/ac) ^{c, d}	Corn Silage Yield ^{c, e} (tons/ac)	Grain Corn Yield ^{c, f} (bu/ac)
Forage Only	200	60	0	2 (5520 hrs.)	2.6	14.0	-
Corn Grain	250	125	125	2.5 (6900 hrs.)	3.2	14.5	80
Crop Sales	400	250	250	2.5 (6900 hrs.)	3.2	14.5	95

^aAll farms have cows with 1300 pound body weights, 28 percent culling rate, 15 percent calf death loss and 13 month calving interval. The latter two characteristics mean 78 percent of cows produce a live replacement.

^bAdditional labor requirements hired at \$3.55/hour.

^cAll yields are harvested quantities on an as is basis (See Table 11 for dry matter percentage).

^dStored as dry hay with a 4 percent dry matter loss.

^eStored in conventional upright silo with an 8 percent dry matter loss.

^fStored as dry-shelled corn with a 2 percent dry matter loss.

acres of crop land) located on medium to poor quality land and capable of roughage production only. On the basis of the Farm Business Summary data, it is assumed that 60 acres (30 percent) can grow corn silage and the remaining cropland must produce mainly grass hay production (the nutrient composition is specified in Table 11). Two full time equivalent workers (5,520 hours) are provided by the family labor force. Other labor requirements must be met through hiring at an assumed rate of \$3.55 per hour. Based upon the Farm Business Summary, harvested hay yields per acre are 2.3 tons dry matter or 2.6 tons on an as is basis. Corn silage yields after harvest are 14.0 tons per acre as fed or 4.6 tons dry matter.

The other two representative farms characterize larger dairy operations but differ with respect to their land resource. Both are assumed capable of corn grain production but one must purchase some grain to feed the herd while the other has sufficient land to produce all feed requirements, except protein and mineral supplements, with a residual harvest available for off-farm sale. The former operation consists of 250 acres of tillable land, half of which are capable of producing corn crops. The remaining 125 acres must produce mixed mainly legume hay. The latter farm consists of 400 acres of crop land of which 250 or 62.5 percent can be utilized for corn. In both cases, the hay yield is 3.2 tons (as harvested) per acre. Likewise, corn silage yields averaged 14.5 tons harvested per acre. Corn grain yields are 80 bushels per acre for the 250 acre operation and 93 bushels per acre for the 400 acre operation. In the case of corn grain produced for off farm sale, a \$3.00 per bushel selling price is used.

Farm Production Costs. Variable costs excluding labor and annual labor requirements for all enterprises are contained in Table 12. Variable costs for crop enterprises include seed, fertilizer, chemicals, fuel, machinery repairs, and harvesting expenses. Variable expenses for dairy enterprises include veterinary, breeding, bedding, supplies, building repairs, and livestock marketing but do not include feed as those expenses are incurred by the crop enterprises or through purchased feeds. These costs and labor requirements were developed largely from the Oklahoma State University Farm Enterprise Data System's (FEDS, Krenz) budgets. The FEDS budgets provide a consistent data set across the United States which can be utilized to expand the regional scope of this analysis if desired. However, the most recent set of crop budgets available at the time of the analysis was for 1981. To insure consistency across enterprises and with the selected yield levels, adjustments were made using Knoblauch and Milligan (1982) for the crop enterprises and Knoblauch (1981) and Milligan *et al.*, (1981b) for dairy enterprises.

Although FEDS divides New York into four production regions, the hay budget (alfalfa hay and other hay) and corn silage budget are derived for the state as a whole because of the small variance in costs across the region. Four separate FEDS corn grain budgets are provided for New York. The budget for the production area where the majority of New York dairy farms are located is used. The labor requirements from these budgets were modified to represent labor disappearance rather than machine time according to Knoblauch and Milligan (1982).

Table 11

NUTRIENT CONTENT OF AVAILABLE FEEDS^a

Feedstuff	Dry Matter (%)	Adjusted Crude Protein	Adjusted ADF	Net Energy ^b Mcal/#DM	Discount Factor ^c (%)
Mixed Mainly grass ^d	88	12.5	40.0	0.62	5.5
Mixed mainly legume Hay ^e	87	15.5	38.0	0.65	4.0
Corn Silage	33	8.5	28.0	0.79	5.3
Corn Grain, yellow	89	10.0	0.5	1.01	3.3
Soybean Oil Meal - 44	90	48.9	2.0	0.92	5.1

^aNutrient contents come from Milligan, et al. (1981a) which are largely based on National Research Council (1978).

^bix maintenance (Net energy for lactation per pound of dry matter).

^cPercent discount of energy value per increment of maintenance.

^dAvailable on roughage only farm.

^eNot available on roughage only farm.

Table 12

VARIABLE COSTS AND LABOR REQUIREMENTS^a

	Hay Crop (Per Acre)	Corn Silage (Per Acre)	Corn Grain (Per Acre)	Dairy Cow (Per Cow)	Dairy Heifer (Per Heifer Birth)
Variable Costs Excluding Labor (\$)	62	148	136	216	183
Labor Requirement (hrs.)	11.7	8.3	5.9	87.75/65 ^b	25.0

^aAll dollar values and labor requirements are annual except for dairy heifers, which cover the time period between birth and freshening.

^b87.75 for forage only farm with stanchion barn; 65 for 100 cow dairy with free stall barn.

The FEDS budgets for 1980 were used as the basis to obtain the variable costs (excluding labor, feed, and hauling) for the dairy cow enterprise. Because these variable costs account for a relatively small percentage of the total variable costs incurred in producing milk, and because the general farm price level did not change substantially over the 1980-1981 period, the 1980 values were considered appropriate. As there are no FEDS replacement heifer budgets, 1980 heifer budgets compiled by Milligan, Nowak and Knoblauch (1981) are used. The labor requirement is 25 hours per replacement from birth to freshening.

Table 13 details the various prices or costs used. The USDA Agricultural Prices Annual Summary (Crop Reporting Board 1980, 1981, 1982) were consulted to specify the price of corn grain and soybeans. Because the relative prices of these two feedstuffs are important, a single price year was not considered sufficient. Instead, the average price of corn (per bushel) received by farmers and the average price paid by farmers per hundred weight of soybean oil meal 44 was calculated for 1980-1982. Fifty cents was added to the average price of corn received to obtain purchase prices. The resulting price of \$3.50/bu. of corn and \$15.60/cwt of soybean oil meal is then used in the model's respective purchasing activities.

Table 13

PRICES USED BY THE LINEAR PROGRAMMING MODEL

Item	Price or Cost (\$)
Milk - net of marketing (\$/cwt)	12.69
Sell Cull cows (\$/hd)	593.00
Sell Replacement Heifers (\$/hd)	1172.00
Sell Bull Calves (\$/hd)	53.00
Buy corn (\$/bu)	3.50
Buy SBM-44 (\$/cwt)	15.60
Buy Premix (\$/cwt)	18.74
Buy Cottonseed (\$/cwt)	19.95
Hire labor (\$/hr)	3.55

Although the composition of the premix required per head will vary slightly according to level of production, an average price of \$18.74/cwt is used (based on rations formulated using the ration program described later). In some rations, cottonseed meal was required to balance the ration. An average price of \$19.95/cwt is used for this ingredient. The price at which labor can be hired, \$3.55/hour, is from the 1981 FEDS Budgets. The prices at which replacement heifers, cull cows, and bull calves are sold are obtained from the USDA 1981 Agricultural Prices Annual Summary (Crop Reporting Board (1982)). The price of milk minus the hauling expenses is that found in the 1980 Dairy FEDS Budget (12.69/cwt. of milk net of marketing costs).

Representative Farm LP Tableau

The information discussed above and the feed budgets discussed in the next section are used to construct the linear programming tableaus for the representative farms. Figure 6 is a schematic of the tableaus. In order to measure the impact of bGH on crop acreages, three activities are included for both the dairy cow and dairy heifer enterprise. The three activities represent costs, labor requirements and feed requirements for prescribed combinations of hay crop and corn silage. The three forage compositions are all hay, half hay and corn silage on a dry matter basis, and three-fourths corn silage on a dry matter basis. The combination of the three activities, then, provides the forage composition to maximize returns. The entries for these activities come from the feed requirements discussed in the next section and in Tables 10 and 12.

The second set of activities includes those to sell the outputs of the dairy enterprises -- milk, cull cows, bull calves, surplus replacements -- at the prices shown in Table 13. The crop production activities contain the outputs (yields from Table 10) and costs (variable costs and labor requirements from Table 12) for hay, corn silage, and/or corn grain. Feed purchase, crop sale, and labor hire correspond to the prices in Table 13. The corn restriction accounting activity introduces the proportion corn acreage can be of total acreage.

The objective function is to maximize return over variable costs. Since bGH does not influence fixed resources, fixed costs do not change and this objective function is equivalent to profit maximization. The only assumption implicit in not changing fixed resources is that crop enterprise changes will not exceed machinery or feed storage capacities.

The labor restriction simply requires that labor in excess of family inputs (Table 10) be hired. The crop acre and rotation constraints limit total acres (Table 10) and corn acres to the proportion allowed.

The feed accounting rows for hay crop, corn silage, corn grain, soybean meal, cottonseed meal, and premix insure that crop production and/or feed purchases meet or exceed quantities required to feed cows and replacements with excesses sold. The harvested yields are reduced by the storage loss (Table 10) prior to inclusion in these rows. The milk accounting row insures that production in all three dairy cow activities is sold. The calf and cull cow accounting rows insure that cows included in the 28 percent culling rate are sold, bull calves are sold, and heifer calves are used as replacements or sold.

Figure 6: SCHEMATIC OF LP MATRIX FOR THE REPRESENTATIVE FARMS

Activities Constraints	Dairy Cow & Heifer Enterprises	Sell Replacements, Culls, Bull Calves & Milk	Crop Production Enterprises	Feed Purchase	Crop Sales	Labor Hire	Corn Restriction Accounts
Objective Function (MAX Returns over Variable Cost)	x	x	x	x	x	x	
Labor Requirements	x		x			x	
Crop Acre & Rotation Constraints			x				x
Feed Accounting	x	x	x	x	x		
Milk Accounting	x	x					
Calf and Cull Cow Accounting	x	x	x				

a "x"'s indicate that non-zero entries are contained in the cell

THE FEEDING PROGRAM

The ration for each of the representative farms for each bGH response level is formulated for the three alternative forage compositions given available feedstuffs by using the Least Cost Balanced Dairy Ration Program developed by Milligan *et al.* (1981a). The least cost nutritionally balanced ration varies according to the cow's age, productivity, weight etc. The nutrient requirements used in this program are based on the National Research Council (1978) and met by the feedstuffs which are specified as being available.

The rations for the representative farms are formulated with cows divided into three feeding groups according to their stage of lactation and production level. To reflect the range of productions receiving the ration, a lead factor is used to balance the ration for a higher production level than the group average. If this adjustment is not made approximately 50 percent of the cows are underfed. By adjusting the ration for a higher level of production (lead factor x average daily production), the requirement of most of the animals in the group should be met without excessively overfeeding the lower producing cows in that group. The lead factor varies with the spread in production levels and the stage of lactation.

Based on work by Oltenacu *et al.* (1976), cows average 91 days in the early lactation group, 120 days in the mid-lactation group, and 95 days in the late lactation group producing 36.0 percent, 42.9 percent and 21.1 percent of their total milk production per year in each of these groups, respectively. (They remain dry the remaining 59 days of the year). For cows producing 13,000 pounds/year this implies an average production per day of 51, 46 and 29 pounds per day for cows in the early, mid and late lactation groups, respectively (Table 14). Similarly for the 16,000 pound/year cows, this implies average daily production of 63, 57 and 35 pounds in the early, mid and late lactation groups. The lead factors used in this study are the same as those specified by Ramsey (1983) which were based on recommendations by Sniffen. They are 1.05 for the high production group, 1.10 for the medium production group and 1.12 for the low production group.

Daily rations are formulated for each group under each of the alternate forage compositions specified. This information is then incorporated with information on the length of time each cow spends in each production group (including the dry cow group) to obtain the annual feed requirements per cow under each feeding program. Because the rations are formulated using lead factors, they are readjusted slightly to reflect actual intake of the cows.

In addition to the milking cow rations, rations are formulated for replacement heifers. Fox and Nowak (1981) calculated rations under these alternative forage compositions for heifers on farms with mostly mixed grass as the hay source. These are incorporated into the representative farm model using mixed mainly grass hay. In addition they also calculated rations for heifers on farms with mixed mainly legume hay, crop silage, and high moisture corn. These rations were converted to equivalent rations using mixed mainly legume hay and corn grain by adjusting the rations for differences

Table 14

PRODUCTION BY GROUPS

Production Period	% of total Milk	Average Days	FAT %	Average Daily Production ^a No bGH	Percentage Increase Due to bGH ^b		
					6.4	12.8	19.2
13,000 lb. Base Production ^c							
Early	36.0	91	3.4	51	51	51	51
Mid	42.9	120	3.6	46	51	55	60
Late	21.1	95	3.4	29	32	35	38
Dry	-	59	-	-	-	-	-
16,000 lb. Base Production ^c							
Early	36.0	91	3.4	63	63	63	63
Mid	42.9	120	3.6	57	63	69	74
Late	21.1	95	3.4	35	39	42	46
Dry	-	59	-	-	-	-	-

^aAll values are shown rounded to the nearest pound.

^bCows receive bGH treatment only during mid-lactation and late lactation production periods.

^cProduction with no bGH.

in dry matter content. These adjusted rations are used for the representative farm models feeding mixed mainly legume hay.

Dietary Adjustments Following Application of bGH

For these calculations, the period of bGH treatment was assumed to be mid-lactation (120 days) and late lactation (95 days). The early lactation portion (first 91 days postpartum) was not included. Although increases in milk production have been reported in short term studies with bGH treatment during the early lactation period, the increases are relatively less and no longer-term studies have involved this portion of the lactation cycle (Bauman and McCutcheon, 1984). The exact milk output response to the application of bGH is not known with certainty. However, based on Bauman *et al.* (1985), it is felt that the feed requirements of a lactating cow could change in one of two ways:

- o Voluntary feed intake changes are insufficient to support increased milk production. Thus, diets need to be reformulated at higher nutrient densities to support the nutrient requirements. This adjustment implies that intake response is insufficient to avoid increasing the energy density of the rations.
- o Voluntary intake increases such that the diets formulated for the early lactation period (first 91 days postpartum, non-treatment) are of sufficient nutrient density to support the increased daily milk production during the treatment period. This alternative implies that intake response is sufficient to allow feeding of the same diets but for different periods of time.

Experimental evidence exists to support both scenarios. In short-term studies, increased milk production with bGH has been observed while no change in feed intake occurs (see review by Bauman and McCutcheon). In longer-term studies, the increased milk production occurs but after a few weeks voluntary feed increases to a level necessary to support the extra milk produced (Bauman *et al.*, 1985; Peel *et al.*, 1985). Both alternatives assume that the nutrient requirements for maintenance and for each increment of milk are not altered by growth hormone treatment. These assumptions are valid as shown by experimental results (Peel *et al.*, 1981; Tyrrell *et al.*, 1982; Bauman and McCutcheon, 1985). Thus the increases in efficiency (milk/unit feed) which occur with bGH treatment are the result of diluting the maintenance costs. These mechanisms for increasing efficiency are similar to the gains which have occurred with the use of artificial insemination and genetic selection programs and with the adoption of improved management practices.

It is relatively straightforward to make adjustments in the rations under the first alternative. If the hormone is not administered until the cow reaches the peak of her lactation cycle, then one can assume that only the daily milk production of cows in the middle and late production groups are affected. Results from trials with bGH at Cornell have indicated an increase in production during this last part of lactation anywhere from 15 to 40 percent (Bauman and McCutcheon, 1985). In this study, new rations for each forage composition are formulated (using the least cost balanced

ration program) for each alternative feeding program assuming a 10, 20, 30, and 40 percent increase in production during the last 215 days of the lactation cycle. This increase is 6.4, 12.8, 19.2 and 25.6 percent, respectively, over the total lactation (see Table 14). These rations are then incorporated into the representative farm model to analyze the effect of bGH on the optimal organization of the farm when one maximizes revenue over variable cost.

The second scenario requires a recalculation of intake per cow. To make such an adjustment, the total energy required for the middle lactation group with bGH is calculated. This calculation is based on the net energy requirement equation in Milligan *et al.* (1981a). Then, the energy density of the early lactation ration and the quantity of this ration required are calculated. The resulting ration meets the energy needs of a cow with a higher level of production. Although the ratio between net energy requirements and crude protein will not remain exactly the same as production increases, it is assumed that the increase in requirements for crude protein will be met once the ration has been adjusted for the increased net energy required. Just as in the first alternative, only the rations of cows in the middle and late lactation groups must be adjusted since the hormone is not administered until peak production has been reached. Again, rations are reformulated for a 10, 20, 30 and 40 percent increase in production during the last 215 days in lactation so that results under these two scenarios can be compared.

RESULTS OF RATION REFORMULATION

Annual feed requirements were formulated for combinations of the following:

- o Two alternative intake responses (for 16,000 pounds production only),
- o Three forage compositions (all hay, half and half, three-quarters corn silage),
- o Two hay crop qualities,
- o Production without bGH of 13,000 and 16,000 pounds of milk per cow per year,
- o No bGH and four response levels.

Annual feed requirements meeting all nutrient requirements for the prescribed production level (Milligan *et al.*, 1981a) were formulated for each of the 84 combinations of the above factors. These feed requirements, by production group and annual, are displayed in Appendix Z for normal intake and in Appendix AA for enhanced intake.

In the discussion that follows, we concentrate on the impact of bGH response levels with the focus on the half-and-half forage composition with mixed mainly legume hay (MML) at the pre-bGH 16,000 production level.

Reference is made to other forage compositions, hay quality, and base production levels only when the results are not totally consistent. To further clarify the presentation, we will concentrate on no bGH, 20 percent (12.6 percent for the total lactation) and 40 percent (25.6 percent for the total lactation) response.

The feed requirement formulation program utilizes the representative farm characteristics (Tables 9 and 10), nutrient contents (Table 11) and prices (Table 13) except that the farm produced feeds must be assigned a price directly (corn grain - \$3.50/bu; corn silage - \$22/ton; MML - \$69/ton; MMG - \$62/ton) rather than through the crop production enterprises.

The results portray a significant increase in both costs and profits per cow with bGH administration (Tables 15 and 16). As indicated earlier, the indicated increases in milk production represent a 20 and 40 percent increase over the post-peak response period.

Table 15

COMPARISON OF ANNUAL FEED REQUIREMENTS BY RESPONSE TO bGH AND FEED INTAKE ASSUMPTION IN THE BASE CASE^a

Annual Requirements, Costs, or Returns	No bGH	12.8% Response		25.6% Response	
		Normal Intake	Enhanced Intake	Normal Intake	Enhanced Intake
Production, lbs/year	16,000	18,048	18,048	20,096	20,096
Concentrate Cost, \$	302	437	367	593	433
Total Ration Cost, \$	697	808	795	940	874
Cost per cwt Milk, \$	4.35	4.48	4.41	4.68	4.35
Return over Feed and Marketing Costs, \$	1,334	1,483	1,495	1,610	1,677
Return over Feed and Marketing Costs/cwt, \$	8.34	8.21	8.28	8.01	8.34
Feed Intake per cwt Milk, lbs	84.3	78.3	82.7	73.8	78.9

^a16,000 production without bGH and forage half from corn silage and half from MML.

Table 16

COMPARISON OF PERCENT INCREASES IN FEED REQUIREMENT BY RESPONSE TO bGH
AND FEED INTAKE ASSUMPTION FOR BASE CASE^a
(percent)

Annual Requirements, Costs, or Returns	12.8% Response		25.6% Response	
	Normal Intake	Enhanced Intake	Normal Intake	Enhanced Intake
Production	12.8	12.8	25.6	25.6
Concentrate Cost	44.7	21.5	96.4	43.4
Total Ration Cost	15.9	14.1	34.9	25.4
Return Over Feed and Marketing Costs	11.2	12.1	20.7	25.7
Total Intake	4.7	10.7	10.0	17.6

^a16,000 production without bGH and forage half from corn silage and half from MML.

The total intake of feed increases less rapidly than the increase in milk production, especially with normal intake assumptions (Table 16). As a result, the nutrient densities of the rations must increase, resulting in larger proportions of concentrates (corn grain, soybean meal and premix). The resulting impact on cost is that concentrate cost increases dramatically, and as concentrate prices exceed forage costs, total costs are proportionally greater than production increases (Tables 15 and 16). Because the enhanced intake requirements presume bGH results in extra stimulation to both production and intake, the increases in concentrate and total cost are moderated. In fact, at the 25.6 percent response level, milk and total feed cost increase essentially proportionally.

Return over feed and milk marketing costs shows a dramatic increase, although proportionately less than the increase in production (except with large responses with enhanced intake). Based on research to date, the other traditional expense items -- breeding, veterinary, labor, supplies, etc. -- are not expected to increase more than marginally. The return over feed cost and marketing is then the additional income available (before any market-wide adjustments) to purchase the product (bGH) and enhance profits. This return is several times greater than the expected production costs discussed earlier.

Effect of Hay Crop Quality

Hay crop quality has a small impact on the economic response to bGH (Tables 17 and 18). Although the dollar increase in both concentrate and feed cost is greater with MMG (Table 17), the percentage increase is less and similar, respectively (Table 18). Since the proportionate increase in return over feed cost and marketing is relatively constant, the absolute dollar increase is less for MMG. When hay crop is the only forage, the profitability of the response is dampened considerably with MMG.

Effect of Forage Composition

Results when the forage is either all hay (MML) or 75 percent corn silage are very similar to those with the forage equal parts hay and corn silage (Tables 19-21). Without bGH, the half and half forage composition is the least expensive for the prices used. With a 25.6 percent bGH response rate, the all-hay ration becomes least cost with the increased

Table 17

COMPARISON OF ANNUAL FEED REQUIREMENTS PER COW
BY HAY CROP QUALITY AND INTAKE ASSUMPTION FOR
16,000 PRODUCTION AND HALF-AND-HALF FORAGE COMPOSITION

Annual Requirements, Costs, or Returns	MML ^a			MMG ^a		
	No bGH	25.6% Increase Normal Intake	Enhanced Intake	No bGH	25.6% Increase Normal Intake	Enhanced Intake
Production, lbs/year	16,000	18,048	18,048	16,000	18,048	18,048
Concentrate Cost, \$	302	593	433	407	714	575
Total Ration Cost, \$	697	940	874	755	1,012	949
Cost per cwt Milk, \$	4.35	4.68	4.35	4.72	5.04	4.72
Return Over Feed and Marketing Costs, \$	1,334	1,610	1,677	1,275	1,538	1,601

^aMML opportunity cost price is \$69/ton;
MMG is \$62/ton.

Table 18

EFFECT OF HAY CROP QUALITY ON PERCENT INCREASES
IN PER COW FEED REQUIREMENTS WITH A 25.6% RESPONSE TO bGH^a
(percent)

Annual Requirements, Costs, or Returns	MML ^a		MMG ^a	
	25.6% Increase Normal Intake	Enhanced Intake	25.6% Increase Normal Intake	Enhanced Intake
Production	25.6	25.6	25.6	25.6
Concentrate Cost	96.4	43.4	75.4	41.3
Total Ration Cost	34.9	25.4	34.0	25.7
Return Over Feed and Marketing Costs	20.7	25.7	20.6	25.6

^a16,000 pounds base production, half hay crop and half corn silage forage composition.

Table 19

PER COW COMPARISON OF ANNUAL FEED REQUIREMENTS BY RESPONSE TO bGH
AND FORAGE COMPOSITION FOR 16,000 PRODUCTION AND
NORMAL INTAKE ASSUMPTION

Annual Requirements, Costs, or Returns	All Hay		Half & Half		75% Corn Silage	
	No bGH	25.6% Response	No bGH	25.6% Response	No bGH	25.6% Response
Production, lbs/year	16,000	18,048	16,000	18,048	16,000	18,048
Concentrate Cost, \$	306	584	302	593	341	617
Total Ration Cost, \$	711	926	697	940	735	967
Cost Per Cwt Milk, \$	4.44	4.61	4.35	4.68	4.60	4.81
Return Over Feed and Marketing Costs, \$	1,319	1,624	1,334	1,610	1,295	1,583

Table 20

PER COW COMPARISON OF ANNUAL FEED REQUIREMENT BY RESPONSE TO bGH
AND FORAGE COMPOSITION FOR 16,000 PRODUCTION AND ENHANCED INTAKE

Annual Requirements, Costs, or Returns	All Hay		Half & Half		75% Corn Silage	
	No bGH	25.6% Response	No bGH	25.6% Response	No bGH	25.6% Response
Production, lbs/year	16,000	18,048	16,000	18,048	16,000	18,048
Concentrate Cost, \$	306	432	302	433	342	456
Total Ration Cost, \$	711	864	697	874	735	900
Cost Per Cwt Milk, \$	4.44	4.30	4.35	4.35	4.60	4.48
Return Over Feed and Marketing Costs, \$	1,319	1,686	1,334	1,677	1,295	1,650

Table 21

COMPARISON OF CHANGES IN FEED REQUIREMENTS BY RESPONSE TO bGH,
FORAGE COMPOSITION, AND INTAKE ASSUMPTION FOR 16,000 PRODUCTION
(percent)

	Normal Intake			Enhanced Intake		
	All Hay	Half & Half	75% Corn Silage	All Hay	Half & Half	75% Corn Silage
Production	25.6	25.6	25.6	25.6	25.6	25.6
Concentrate Cost	90.1	96.4	80.9	41.2	43.4	33.3
Total Ration Cost	30.2	34.9	31.6	21.5	25.4	22.4
Return Over Feed and Market- ing Costs	23.1	20.7	22.2	27.8	25.7	27.4

cost of the 75 percent corn silage ration also less than that of the half and half. The reason for the larger increase in cost of the half and half is that the advantage of the mix of forages declines as production increases and more nutrients are obtained from concentrates. This advantage accrues primarily late in the lactation.

With the lower quality MMG, the increases with bGH remain similar; however, the relative changes differ. The 75 percent corn silage ration increases in profitability to the point where it is the least cost ration, while the changes in the other two forage compositions are almost identical.

Effect of Production Level

We have focused on the higher production level herds because they are less likely to have limitations that will limit or preclude response to bGH. Tables 22 and 23 compare the results for the pre-bGH 13,000 and 16,000 annual production herds. The results, assuming a normal intake response, are very similar. In percentage terms, the profitability response is greater with the lower production herd because the nutritional constraints are easier to meet; however, the dollar increase is significantly less.

Table 22

EFFECT OF MILK PRODUCTION ON PER COW RESPONSE TO bGH^a

	13,000 Herd			16,000 Herd		
	No bGH	12.8% Response	25.6% Response	No bGH	12.8% Response	25.6% Response
Production, lbs/yr	13,000	14,664	16,328	16,000	18,048	20,096
Concentrate Cost, \$	115	203	311	302	437	539
Total Ration Cost, \$	543	625	712	697	808	940
Cost Per Cwt Milk, \$	4.18	4.26	4.36	4.35	4.48	4.68
Return Over Feed and Marketing Costs, \$	1,106	1,236	1,360	1,334	1,483	1,610

^aHalf MML hay and half corn silage with normal intake.

Table 23

INCREASE IN FEED REQUIREMENT FOR DIFFERENT MILK
PRODUCTION LEVELS WITH bGH^a
(percent)

	12.8% Increase		25.6% Increase	
	13,000	16,000	13,000	16,000
Concentrate Cost	76.5	44.7	170.4	78.5
Total Ration Cost	15.1	15.9	31.1	34.9
Return Over Feed Cost	11.8	23.0	23.0	20.7

^aHalf MML hay and half corn silage with normal intake.

Return Per Day of Administration

The true test of bGH will be the return over feed and marketing costs compared to the cost of obtaining and administering bGH. In this analysis, response is based on 215 days of administration. Dividing the days of administration into the return over feed and marketing costs provides perspective on profitability (Table 24). As shown, the return exceeds the costs for all combinations at both response levels. This return is available for bGH purchase, administration costs and enhanced profit.

RESULTS OF REPRESENTATIVE FARM ANALYSIS

In analyzing the impact of bGH, it is important to realize that a change of this magnitude in feed rations has ripple effects throughout the farm operation. In addition to the expected changes in feed requirements and profitability, crop acres, feed purchases and/or sales and labor requirements may change. The economic issue, then, is how the total, and therefore marginal, revenues and costs of the whole dairy farm operation react to bGH response.

The previous section illustrated the profitability of bGH with no change in roughage proportions. In this section we consider return over variable cost but look especially at impacts on farm enterprise organization and compare the changes in the three representative farms.

Normal Intake

Tables 25 through 27 detail the results of the analysis pertaining to feed rations assuming normal intake. On all representative farms, it is clear that the return over variable costs increases with increasing response to bGH at the milk price of \$12.69 per cwt. This increase ranges from near 6 percent for farms at the 6.4 percent response rate to 20-25 percent at the 25.6 percent response rate.

Table 24

PER COW INCREASE IN RETURN OVER FEED AND MILK MARKETING COSTS
PER DAY OF ADMINISTRATION OF bGH^a
(\$)

	12.8% Increase		25.6% Increase	
	Normal Intake	Enhanced Intake	Normal Intake	Enhanced Intake
Base ^b	0.69	0.75	1.28	1.60
Base, with MMG instead of MML	0.70	0.72	1.22	1.52
Base, with all MML hay instead of half and half	0.75	0.80	1.42	1.71
Base, with 13,000 instead of 16,000	0.60	--	1.18	--

^aIncrease in return over feed and marketing costs compared to no bGH divided by 215 days of response to bGH.

^b16,000 pounds production without bGH using half MML hay and half corn silage.

The economic benefits of administering the hormone vary across the three farm types and two production groups. The small forage only farm, at a given response rate, improves its return over variable costs by a somewhat higher percentage than the larger farms. Low producing herds increase their percentage return more than higher producers on small and medium size farms but high producers have a slight advantage on larger farms (Table 28). On a per cow basis increased return is greatest on the large farm with corn grain sales because the increased feed required reduces crop sales as opposed to increasing feed purchases. The per cow increase in returns over variable costs is lowest on the small farm with a low producing herd. Likewise, the increase in return per hundredweight of additional milk production is greater on the larger farm (but generally at the lower production level).

The marginal cost per hundredweight of milk production behaves as expected, with marginal costs generally increasing as production response to bGH improves. The values range from 4 to 6 cents per pound of milk production -- well within the range assumed in the last section. The low end of the range is, as expected, for the cash sales representative farm.

Table 25

IMPACTS OF bGH ON FORAGE ONLY REPRESENTATIVE FARMS BY RESPONSE RATE AND AVERAGE ANNUAL MILK PRODUCTION WITH THE NORMAL INTAKE ASSUMPTION^a

Item Impacted	No bGH	6.4% Response	12.8% Response	19.2% Response	25.6% Response
13,000# Base Herd Production Average					
Return over Variable					
Costs (\$)	68,292.77	72,529.05	76,813.51	81,257.35	85,210.27
Acres Used	200.00	200.00	200.00	200.00	200.00
Corn Acres	60.00	60.00	60.00	60.00	60.00
Grain Acres	0.00	0.00	0.00	0.00	0.00
Silage Acres	60.00	60.00	60.00	60.00	60.00
Hay (MMG) Acres	140.00	140.00	140.00	140.00	140.00
Ave. Forage Comp. of Cow Ration (h/s)	51/49	50/50	49/51	48/52	47/53
Milk Production (cwt)	8,450.0	8,990.8	9,531.6	10,072.4	10,613.2
Purchased Feed					
Premix (cwt)	159.02	166.98	174.63	182.36	190.81
Soy-44 (cwt)	693.98	801.35	898.50	995.10	1,105.90
Corn (bu)	896.51	1,284.36	1,686.79	2,065.73	2,545.44
Sell Feed					
Hay (MMG) Tons	74.32	82.25	89.24	97.23	106.60
Corn (Bu)	0.00	0.00	0.00	0.00	0.00
Net Purchased Feed (\$) ^b	11,742.00	14,368.00	16,946.00	19,365.00	22,275.00
Marginal Cost/CWT Milk (\$) ^c	—	4.86	4.81	4.70	4.87
Hired Labor (hrs)	2,953.50	2,953.50	2,953.50	2,953.50	2,953.50
Marginal Return to Land and Machinery (\$/Acre)	102.34	85.89	85.41	83.91	83.05
Marginal Return to Cows and Assoc. Facilities (\$/Cow)	434.30	550.07	617.47	690.46	753.90
16,000# Base Herd Production Average					
Return over Variable					
Costs (\$)	83,395.33	88,273.26	93,192.95	97,499.56	101,953.50
Acres Used	200.00	200.00	200.00	200.00	200.00
Corn Acres	57.02	55.55	54.09	52.68	51.42
Grain Acres	0.00	0.00	0.00	0.00	0.00
Silage Acres	57.02	55.55	54.09	52.68	51.42
Hay (MMG) Acres	142.98	144.45	145.91	147.32	148.58
Ave. Forage Comp. of Cow Ration (h/s)	50/50	50/50	50/50	50/50	50/50
Milk Production (cwt)	10,400.0	11,065.6	11,715.6	12,396.8	13,062.4
Purchased Feed					
Premix (cwt)	185.76	195.51	202.01	213.71	228.66
Soy-44 (cwt)	1,009.80	1,163.20	1,280.20	1,349.10	1,353.65
Corn (bu)	2,735.85	3,266.25	3,907.80	4,501.90	4,845.75
Cottonseed (cwt)	0.00	0.00	0.00	91.00	322.40
Sell Feed					
Hay (MMG) Tons	102.94	113.75	124.55	135.23	165.02
Corn (Bu)	0.00	0.00	0.00	0.00	0.00
Net Purchased Feed (\$) ^b	21,604.00	25,279.00	28,716.00	33,157.00	37,243.00
Marginal Cost/CWT Milk (\$) ^c	—	5.36	5.24	5.63	5.72
Hired Labor (hrs)	2,953.7	2,968.62	2,973.59	2,978.38	2,982.67
Marginal Return to Land and Machinery (\$/Acre)	71.36	71.36	71.36	71.36	71.36
Marginal Return to Cows and Assoc. Facilities (\$/Cow)	761.97	837.02	912.71	978.96	1,047.49

^a200 crop acres with maximum of 30 percent in corn, hay crop is mixed mainly grass, 65 cows with either 16,000 or 13,000 pounds milk sold per cow without bGH.

^bTotal purchased feed expenses less crop sales.

^cChange in all feed purchases, crop sales and crop enterprise expenses divided by hundredweight change in milk production. All changes from no bGH.

Table 26

IMPACTS OF bGH ON CORN GRAIN REPRESENTATIVE FARMS BY RESPONSE RATE AND AVERAGE ANNUAL MILK PRODUCTION WITH THE NORMAL INTAKE ASSUMPTION^a

Item Impacted	No bGH	6.4% Response	12.8% Response	19.2% Response	25.6% Response
13,000# Base Herd Production Average					
Return over Variable Costs (\$)	120,282.00	126,823.00	133,254.00	139,893.00	145,757.00
Acres Used	250.00	250.00	250.00	250.00	250.00
Corn Acres	94.54	101.13	102.42	104.69	107.60
Grain Acres	5.19	11.93	14.05	17.75	22.46
Silage Acres	89.35	89.20	88.37	86.94	85.14
Hay (MML) Acres	155.46	148.87	147.58	145.31	142.40
Ave. Forage Comp. of Cow Ration (h/s)	50/50	50/50	50/50	50/50	50/50
Milk Production (cwt)	13,000.0	13,832.0	14,664.0	15,496.0	16,328.0
Purchased Feed					
Premix (cwt)	147.80	153.80	167.80	177.80	191.80
Soy-44 (cwt)	626.58	737.58	861.58	1,010.58	1,181.58
Corn (bu)	0.00	133.40	669.92	1,044.79	1,514.86
Sell Feed					
Hay (MML) Tons	19.36	0.00	0.00	0.00	0.00
Purchased Feed (\$)	11,189.00	14,355.00	18,930.00	22,754.00	27,329.00
Marginal Cost/CWT Milk (\$)^b	--	4.83	4.89	4.83	5.04
Hired Labor (hrs)	3,166.00	3,128.00	3,118.00	3,101.00	3,080.00
Marginal Return to Land and Machinery (\$/Acre)	112.66	115.68	115.68	115.68	115.68
Marginal Return to Cows and Assoc. Facilities (\$/Cow)	676.00	734.00	798.00	865.00	923.00
16,000# Base Herd Production Average					
Return over Variable Costs (\$)	142,975.00	150,504.00	157,759.00	165,554.00	171,699.00
Acres Used	250.00	250.00	250.00	250.00	250.00
Corn Acres	109.22	111.81	115.37	117.96	49.67
Grain Acres	24.98	29.15	34.97	39.14	27.09
Silage Acres	84.24	82.66	80.40	78.82	22.58
Hay (MML) Acres	140.78	138.19	134.63	132.04	200.33
Ave. Forage Comp. of Cow Ration (h/s)	50/50	50/50	50/50	50/50	100/0
Milk Production (cwt)	16,000.0	17,024.0	18,024.0	19,072.0	20,096.0
Purchased Feed					
Premix (cwt)	191.80	205.80	220.80	235.80	209.80
Soy-44 (cwt)	1,110.58	1,320.58	1,524.58	1,716.58	1,112.58
Corn (bu)	1,417.27	1,937.17	2,458.56	3,064.46	8,032.91
Cottonseed (cwt)	0.00	0.00	0.00	0.00	206.00
Sell Feed					
Hay (MML) Tons	0.00	0.00	0.00	0.00	0.00
Purchased Feed (\$)	25,880.00	31,238.00	36,526.00	41,876.00	53,513.00
Marginal Cost/CWT Milk (\$)	--	5.34	5.39	5.34	5.67
Hired Labor (hrs)	3,069.00	3,050.00	3,024.00	3,005.00	3,266.00
Marginal Return to Land and Machinery (\$/Acre)	115.68	115.68	115.68	115.68	115.68
Marginal Return to Cows and Assoc. Facilities (\$/Cow)	896.00	971.00	1,043.00	1,121.00	1,183.00

^a250 crop acres with maximum of 50 percent in corn, hay crop is mixed mainly legume, 100 cows with either 13,000 or 16,000 pounds milk sold per cow without bGH.

^bChange in all feed purchases, crop sales and crop enterprise expenses divided by hundredweight change in milk production. All changes from no bGH.

Table 27

IMPACTS OF bGH ON CROP SALES REPRESENTATIVE FARMS BY RESPONSE RATE AND
AVERAGE ANNUAL MILK PRODUCTION WITH NORMAL INTAKE ASSUMPTION^a

Item Impacted	No bGH	6.4% Response	12.8% Response	19.2% Response	25.6% Response
13,000# Base Herd Production Average					
Return over Variable					
Costs (\$)	137,852.00	144,703.00	151,481.00	158,446.00	164,719.00
Acres Used	400.00	400.00	400.00	400.00	400.00
Corn Acres	250.00	250.00	250.00	250.00	250.00
Grain Acres	160.65	160.81	161.63	163.06	164.87
Silage Acres	89.35	89.19	88.37	86.94	85.13
Hay (MML) Acres	150.00	150.00	150.00	150.00	150.00
Ave. Forage Comp. of Cow Ration (h/s)	50/50	50/50	50/50	50/50	50/50
Milk Production (cwt)	13,000.0	13,832.0	14,664.0	15,496.0	16,328.0
Purchased Feed					
Premix (cwt)	147.80	153.80	167.80	177.80	191.80
Soy-44 (cwt)	626.50	737.58	861.58	1,010.58	1,181.58
Corn (bu)	0.00	0.00	0.00	0.00	0.00
Sell Feed					
Hay (MML) Tons	2.48	3.48	7.48	14.48	23.48
Corn (Bu)	14,214.53	13,569.21	12,942.47	12,409.47	11,735.68
Net Purchased Feed (\$) ^b	-30,270.00	-26,563.00	-22,766.00	-19,144.00	-14,824.00
Marginal Cost/CWT Milk (\$) ^c	—	4.46	4.50	4.44	4.62
Hired Labor (hrs)	4,019.00	4,019.00	4,017.00	4,014.00	4,009.00
Marginal Return to Land and Machinery (\$/Acre)	114.54	114.54	114.54	114.54	114.54
Marginal Return to Cows and Assoc. Facilities (\$/Cow)	675.00	744.00	812.00	881.00	944.00
16,000# Base Herd Production Average					
Return over Variable					
Costs (\$)	161,981.00	170,695.00	178,459.00	186,933.00	194,145.00
Acres Used	400.00	400.00	400.00	400.00	400.00
Corn Acres	250.00	177.99	186.73	193.20	199.67
Grain Acres	165.77	155.41	164.15	170.62	177.09
Silage Acres	84.23	22.58	22.58	22.58	22.58
Hay (MML) Acres	150.00	222.01	213.28	206.80	200.33
Ave. Forage Comp. of Cow Ration (h/s)	50/50	100/0	100/0	100/0	100/0
Milk Production (cwt)	16,000.0	17,024.0	18,024.0	19,072.0	20,096.0
Purchased Feed					
Premix (cwt)	191.80	153.80	175.80	193.80	209.80
Soy-44 (cwt)	1,110.58	720.58	907.58	1,068.58	1,112.58
Corn (bu)	0.00	0.00	0.00	0.00	0.00
Cottonseed (cwt)	0.00	0.00	0.00	0.00	0.00
Sell Feed					206.00
Hay (MML) Tons	28.48	0.00	0.00	0.00	0.00
Corn (Bu)	11,718.79	6,995.14	6,619.28	6,076.28	5,969.28
Net Purchased Feed (\$) ^b	-16,231.00	-6,862.00	-2,405.00	2,073.00	7,520.00
Marginal Cost/CWT Milk (\$) ^c	—	4.18	4.55	4.57	4.84
Hired Labor (hrs)	4,007.00	4,277.00	4,226.00	4,189.00	4,151.00
Marginal Return to Land and Machinery (\$/Acre)	114.54	115.68	115.68	115.68	115.68
Marginal Return to Cows and Assoc. Facilities (\$/Cow)	917.00	999.00	1,077.00	1,162.00	1,234.00

^a400 crop acres with maximum of 62.5 percent in corn, hay crop is mixed mainly legume, 100 cows with either 13,000 or 16,000 pounds milk sold per cow without bGH.

^bTotal purchased feed expenses less crop sales.

^cChange in all feed purchases, crop sales and crop enterprise expenses divided by hundredweight change in milk production. All changes from no bGH.

The changes in feed acquisition, which encompass crop enterprise selection, feed purchases, and crop sales, are the product of the feed requirements just analyzed, the crop characteristics (Tables 10 and 12), and the sale and purchase prices (Table 13). The responses on the representative farms with lower production portray marginal adjustments with little or no change in the profit maximizing forage composition (Tables 25-27 and 29). Consistent with the feed requirement section, the ration with half hay crop and half corn silage is the predominant choice. On the forage only farm with the poorer quality MMG hay, the maximum acreage of corn silage is always utilized (with lower production). With greater response to bGH and the corresponding decrease in total forage, the proportion hay crop decreases slightly. On the larger representative farms, forage composition is unchanged while forage acres decline and/or hay sales increase.

In the previous section, it was concluded that the most profitable composition shifted from half and half to all hay with bGH and the higher production level (Tables 19 and 21). This same shift is apparent in the 100 cow representative farms (Tables 26-27). The result is a dramatic adjustment in crop acreages (Table 28). Net feed purchase is greater than if ration composition is unchanged; however, crop expenses show a relative decrease. The magnitude of the shift is a function of the linear programming techniques used. On the forage only farm, with its lower quality hay crop, forage composition is unchanged.

Table 28

REPRESENTATIVE FARM CHANGES DUE TO bGH RESPONSE
WITH 16,000 POUNDS BASE PRODUCTION AND NORMAL INTAKE ASSUMPTION

	12.8% Response			25.6% Response		
	Forage Only	Corn Grain	Crop Sales	Forage Only	Corn Grain	Crop Sales
Increase in ROVC ^a						
Farm, \$	9,798	14,784	16,478	18,558	28,723	32,164
Per Cow, \$	151	148	165	286	287	322
Marginal Feed Cost/cwt, \$	5.24	5.39	4.55	5.72	5.67	4.84
Change in Crop Acres						
Hay	+ 3	- 6	+63	+ 6	+59	+50
Corn Silage	- 3	- 4	-62	- 6	-62	-62
Corn Grain	--	+10	- 2	--	+ 2	+11
Net Feed Purchase ^b (\$)						
Change (\$)	+7,112	+10,646	+13,825 ^b	+15,639	+27,636	+23,750 ^c
Change (%)	+32.9	+41.1	--	+72.4	+106.8	--

^aReturn over variable costs

^bPurchases minus sales

^cReduction in sales

Table 29

REPRESENTATIVE FARM CHANGES DUE TO bGH RESPONSE
WITH 13,000 POUNDS BASE PRODUCTION AND NORMAL INTAKE ASSUMPTION

	12.8% Response			25.6% Response		
	Forage Only	Corn Grain	Crop Sales	Forage Only	Corn Grain	Crop Sales
Increase in ROVC ^a						
Farm, \$	8,531	12,972	13,629	16,928	25,475	26,867
Per Cow, \$	131	130	137	260	255	269
Marginal Feed Cost (cwt), \$	4.81	4.89	4.50	4.87	5.04	4.62
Change in Crop Acres						
Hay	0	- 8	0	0	-13	0
Corn Silage	0	- 1	- 1	0	- 4	- 4
Corn Grain	--	+ 9	+ 1	--	+17	+ 4
Net Feed Purchase ^b (\$)						
Change (\$)	+5,205	+7,741	+7,508 ^b	+10,533	+16,140	+15,450 ^c
Change (%)	+44.3	+69.2	--	+89.7	+144.2	--

^aReturn over variable costs

^bFeed purchases minus crop sales

^cReduction in excess cash crop sales over feed purchases

Finally, the marginal return to both land (and associated machinery) and cows (and associated facilities) is of interest. Returns to cows and associated facilities are uniformly higher with increased response rates, and generally the percentage increase is higher for low versus high producers, but the absolute increase is greater only for the small farm. Likewise, the percentage increase in marginal return to animals is higher on the small farm than on the two larger farms, but the absolute increase is greater on the larger farms. The marginal return to land is generally stable across all scenarios (except for the small farm, where it declines in the case of the low producing herd), implying that the capitalized value of land will be stable (except for marginal operations where it would decline) while the value of animals and associated real property improvements will rise.

Increase Intake Scenario

Tables 30 through 32 detail the results of the analysis using the enhanced intake assumption. Only the 16,000 pound initial herd production

Table 30

IMPACTS OF bGH ON FORAGE ONLY REPRESENTATIVE FARM BY RESPONSE RATE
WITH 16,000 POUND BASE PRODUCTION AND THE ENHANCED INTAKE ASSUMPTION^a

Item Impacted	No bGH	6.4% Response	12.8% Response	19.2% Response	25.6% Response
Return over Variable					
Costs (\$)	83,395.33	87,485.59	93,338.79	99,127.23	104,780.10
Acres Used	200.00	200.00	200.00	200.00	200.00
Corn Acres	57.02	58.58	59.59	59.79	59.84
Grain Acres	0.00	0.00	0.00	0.00	0.00
Silage Acres	57.02	58.58	59.59	59.79	59.84
Hay (MMG) Acres	142.98	141.42	140.41	140.21	140.16
Ave. Forage Comp. of Cow Ration (h/s)	50/50	50/50	50/50	50/50	50/50
Milk Production (cwt)	10,400.0	11,065.6	11,715.6	12,396.8	13,062.4
Purchased Feed					
Premix (cwt)	185.76	198.76	202.01	211.11	218.91
Soy-44 (cwt)	1,009.80	1,152.15	1,227.55	1,304.90	1,382.90
Corn (bu)	2,735.85	2,996.50	3,177.89	3,560.05	3,972.80
Sell Feed					
Hay (MMG) Tons	102.94	90.59	84.17	82.36	81.59
Corn (Bu)	0.00	0.00	0.00	0.00	0.00
Net Purchased Feed (\$)^b	21,604.00	25,844.00	28,166.00	31,008.00	33,869.00
Marginal Cost/CWT					
Milk (\$) ^c	--	6.54	5.13	4.81	4.66
Hired Labor (hrs)	2,953.7	2,958.34	2,954.91	2,954.23	2,954.06
Marginal Return to Land and Machinery (\$/Acre)	71.36	71.36	71.36	71.36	71.36
Marginal Return to Cows and Assoc. Facilities (\$/Cow)	761.97	824.90	914.95	1,004.00	1,089.86

^a200 crop acres with maximum of 30 percent in corn, hay crop is mixed mainly grass, 65 cows with 16,000 pounds milk sold per cow without bGH.

^bTotal purchased feed expenses less crop sales.

^cChange in all feed purchases, crop sales and crop enterprise expenses divided by hundredweight change in milk production. All changes from no bGH.

Table 31

IMPACTS OF bGH ON CORN GRAIN REPRESENTATIVE FARM BY RESPONSE RATE
WITH 16,000 POUND BASE PRODUCTION AND THE ENHANCED INTAKE ASSUMPTION^a

Item Impacted	No bGH	6.4% Response	12.8% Response	19.2% Response	25.6% Response
Return over Variable					
Costs (\$)	142,975.00	149,556.00	158,909.00	168,755.00	177,683.00
Acres Used	250.00	250.00	250.00	250.00	250.00
Corn Acres	109.22	103.39	100.16	97.57	72.78
Grain Acres	24.98	15.70	10.66	6.49	0.00
Silage Acres	84.24	87.69	89.90	91.08	72.78
Hay (MML) Acres	140.78	146.61	149.84	152.43	177.22
Ave. Forage Comp. of Cow Ration (h/s)	50/50	50/50	50/50	50/50	64/36
Milk Production (cwt)	16,000.0	17,024.0	18,024.0	19,072.0	20,096.0
Purchased Feed					
Premix (cwt)	191.80	205.80	209.80	215.80	207.48
Soy-44 (cwt)	1,110.58	1,268.58	1,367.58	1,470.58	1,339.92
Corn (bu)	1,417.27	2,540.41	3,070.59	3,596.69	5,869.15
Sell Feed					
Hay (MML) Tons	0.00	0.00	0.00	0.00	0.00
Corn (Bu)	0.00	0.00	0.00	0.00	0.00
Purchased Feed	25,880.00	32,538.00	36,013.00	39,574.00	45,333.00
Marginal Cost/CWT					
Milk (\$) ^b	-	6.26	4.82	4.30	4.22
Hired Labor (hrs)	3,069.00	3,110.00	3,134.00	3,153.00	3,253.00
Marginal Return to Land and Machinery (\$/Acre)	115.68	115.68	115.68	115.68	122.28
Marginal Return to Cows and Assoc. Facilities (\$/Cow)	896.00	961.00	1,055.00	1,153.00	1,226.00

^a250 crop acres with maximum of 50 percent in corn, hay crop is mixed mainly legume, 100 cows with 16,000 pounds milk sold per cow without bGH.

^bChange in all feed purchases, crop sales and crop enterprise expenses divided by hundredweight change in milk production. All changes from no bGH.

Table 32

IMPACTS OF bGH ON CROP SALES REPRESENTATIVE FARMS BY RESPONSE RATE
WITH 16,000 POUND BASE PRODUCTION AND THE ENHANCED INTAKE ASSUMPTION^a

Item Impacted	No bGH	6.4% Response	12.8% Response	19.2% Response	25.6% Response
Return over Variable					
Costs (\$)	161,981.00	169,406.00	179,123.00	189,568.00	199,653.00
Acres Used	400.00	400.00	400.00	400.00	400.00
Corn Acres	250.00	164.07	161.48	159.54	157.28
Grain Acres	165.77	141.49	138.90	136.96	134.70
Silage Acres	84.23	22.58	22.58	22.58	22.58
Hay (MML) Acres	150.00	235.93	238.52	240.46	242.72
Ave. Forage Comp. of Cow Ration (h/s)	50/50	100/0	100/0	100/0	100/0
Milk Production (cwt)	16,000.0	17,024.0	18,024.0	19,072.0	20,096.0
Purchased Feed					
Premix (cwt)	191.80	158.80	162.80	167.80	171.80
Soy-44 (cwt)	1,110.58	636.58	654.58	671.58	687.58
Corn (bu)	0.00	0.00	0.00	0.00	0.00
Sell Feed					
Hay (MML) Tons	28.48	0.00	0.00	0.00	0.00
Corn (Bu)	11,718.79	5,910.79	4,992.20	4,125.50	3,223.35
Net Purchased Feed^b	-16,231.00	-4,826.00	-1,714.00	1,245.00	4,276.00
Marginal Cost/CWT					
Milk (\$) ^c	-	5.44	4.22	3.71	3.49
Hired Labor (hrs)	4,007.00	4,358.00	4,373.00	4,384.00	4,397.00
Marginal Return to Land and Machinery (\$/Acre)	114.54	115.68	115.68	115.68	115.68
Marginal Return to Cows and Assoc. Facilities (\$/Cow)	917.00	986.00	1,084.00	1,188.00	1,289.00

^a400 crop acres with maximum of 62.5 percent in corn, hay crop is mixed mainly legume, 100 cows with 16,000 pounds milk sold per cow without bGH.

^bTotal purchased feed expenses less crop sales.

^cChanges in all feed purchases, crop sales and crop enterprise expenses divided by hundredweight change in milk production. All changes from no bGH.

average was evaluated since it adequately represents the general impacts forthcoming from the analysis.

As with the normal intake assumption, the return over variable costs increases with increasing response to bGH (Table 33). In this case, the increase ranges from just under 5 percent for all farms at the 6.4 percent response rate to 25 percent at the 25.6 percent response rate. At any given response rate, the economic benefits of administering the hormone are similar across the three farm types.

On a per cow basis, increased return is still the greatest on the large farm with corn grain sales and decreases progressively with farm size. Likewise, the increase in return per hundredweight of increased milk production increases with farm size.

On the other hand, marginal feed costs per hundredweight of milk production generally decline as production response to bGH improves. This is not unexpected since the ration is not reformulated, and the greater the production response the greater the benefit of the intake assumption. The resulting values range from 3 to 6 cents per pound of production. At high response levels this marginal cost is more than a dollar a hundredweight less than with the normal intake assumption. The savings results from the greater use of forage.

Table 33

REPRESENTATIVE FARM CHANGES DUE TO bGH RESPONSE
WITH 16,000 POUNDS BASE PRODUCTION AND THE ENHANCED INTAKE ASSUMPTION

	12.8% Response			25.6% Response		
	Forage Only	Corn Grain	Crop Sales	Forage Only	Corn Grain	Crop Sales
Increase in ROVC ^a						
Farm, (\$)	9,943	15,934	17,142	21,385	34,708	37,672
Per Cow, (\$)	153	159	171	329	347	377
Marginal Feed Cost (cwt), (\$)	5.13	4.82	4.22	4.66	4.22	3.49
Change in Crop Acres						
Hay	- 3	+ 9	+89	- 3	+36	+93
Corn Silage	+ 3	+ 6	-62	+ 3	-11	-62
Corn Grain	--	-14	-27	--	-25	-31
Net Purchased Feed						
Change (\$)	+6,562	+10,133	+14,517	+12,263	+19,453	+20,628
Change (%)	+30.4	+39.2	--	+56.8	+75.2	--

^aReturn over variable costs

As in the first scenario, purchased feed requirements increase on all farms as response rates increase, and for the 400 acre farm corn grain sales decline. Purchases are substantially below those with the normal intake assumption. At the 25.6 percent response net feed purchase increases are 15 (crop sales) to 42 (corn grain) percent less (Tables 28 and 33). The crop acres are similar to the normal intake assumption, except that acres of forage are increasing rather than decreasing. Finally, similar patterns for the marginal return to land and animals as found in the previous scenario are observed. The marginal return to animals is, however, slightly less in this case.

Response to Changing Milk Prices

Perhaps a more interesting question, however, relates to the implications for the changing marginal values when market prices for milk respond to increased production. Tables 34 through 36 detail these responses, with respect to the return over variable costs, for the three representative farms and the two production levels. Only results for the normal feed intake case are shown. In order to provide insight into the impact of the change in price, fixed costs are estimated for each of the representative farms. Total fixed costs, including operator labor and management, a capital charge, depreciation, property taxes and insurance from Smith (1982), are \$70,000, \$90,000 and \$95,000 for the forage only, corn grain and crop sale representative farms, respectively.³

Figures 7 and 8 portray the return over variable cost and the return over all costs for different milk prices. The direction of the change in the returns is obvious. In all cases, the percentage decline in returns substantially exceeds the percentage change in market milk prices. For example, a 33 percent reduction in milk prices results in a return over variable cost reduction which varies between 44 and 54 percent. The crop sales farm maintains its higher return regardless of the response rate or production level. For all farms, returns over variable costs fell below the no bGH level with a \$1.00/cwt price decline at 12.8 percent bGH response rates and with \$1.70/cwt decline at 25.6 percent response rates. Thus, a 14 percent reduction in the market price for milk is sufficient to make all farmers worse off even with a 25.6 percent bGH production response.

SUMMARY

The administration of bGH and the subsequent production response results in major changes in the dairy cow enterprises and some adjustments in crop rotations. Total feed requirements increase although less than proportionately with production response. Since crop acres remain

³These values represent averages from a sample of 553 New York dairy farms. Operator labor and management is specified at the average level estimated by operator managers (\$15,100). The capital or interest charge is the percent real rate times average investment using comparatively sized farms. Depreciation and insurance are per cow figures times cow numbers, while property taxes are per acre figures times number of acres.

Table 34

RETURN OVER VARIABLE COST ON FORAGE ONLY REPRESENTATIVE FARM
FOR SELECTED MILK PRICE AND RESPONSE LEVELS^a

Milk Prices/CWT	No bGH	6.4% Response	12.8% Response	19.2% Response	25.6% Response
13,000# Base Herd Production Average					
\$12.69	68,293.00	72,529.00	76,814.00	81,257.00	85,210.00
\$11.50	58,237.00	61,830.00	64,471.00	69,271.00	72,581.00
\$10.50	49,787.00	52,839.00	55,939.00	59,199.00	61,967.00
\$9.50	41,337.00	43,848.00	46,408.00	49,127.00	51,354.00
\$8.50	34,077.00	35,420.00	36,876.00	39,054.00	40,741.00
16,000# Base Herd Production Average					
\$12.69	83,395.00	88,273.00	93,193.00	97,500.00	101,954.00
\$11.50	71,019.00	75,105.00	79,251.00	82,747.00	86,409.00
\$10.50	60,619.00	64,040.00	67,536.00	70,351.00	73,347.00
\$9.50	50,219.00	52,974.00	55,820.00	57,954.00	60,284.00
\$8.50	39,819.00	41,908.00	44,105.00	45,557.00	47,222.00

^a200 crop acres with maximum of 30 percent in corn, hay crop is mixed mainly grass, 65 cows with either 13,000 or 16,000 pounds milk sold per cow without bGH.

constant, the extra feed requirements result in increased feed purchases and/or decreased crop sales. Changes in the required forage are generally met through changes in the cropping program.

When intake is assumed to response in a normal pattern, the total forage requirement decreases and forage (hay and corn silage) acreage generally declines. Purchased concentrate increases two to four times as rapidly on the forage only and corn grain representative farms. On the crop sales, farm corn grain sales decrease dramatically.

With the enhanced intake assumption, more forage and concentrate are required. Increases in purchased feed are ameliorated since more nutrients are provided by an acre of forage than by an acre of corn grain. For farms

Table 35

RETURN OVER VARIABLE COST ON CORN GRAIN REPRESENTATIVE FARM
FOR SELECTED MILK PRICE AND RESPONSE LEVELS^a

Milk Price/CWT	No bGH	6.4% Response	12.8% Response	19.2% Response	25.6% Response
13,000# Base Herd Production Average					
\$12.69	120,282.00	126,823.00	133,254.00	139,893.00	145,757.00
\$11.50	104,812.00	110,363.00	115,804.00	121,454.00	126,327.00
\$10.50	91,812.00	96,531.00	101,140.00	105,958.00	109,999.00
\$9.50	78,812.00	82,699.00	86,476.00	90,462.00	93,671.00
\$8.50	65,812.00	68,867.00	71,812.00	74,966.00	77,343.00
16,000# Base Herd Production Average					
\$12.69	142,975.00	150,504.00	157,759.00	165,553.00	171,699.00
\$11.50	123,935.00	130,245.00	136,310.00	142,858.00	147,824.00
\$10.50	107,935.00	113,221.00	118,286.00	123,786.00	127,728.00
\$9.50	91,935.00	96,197.00	100,262.00	104,714.00	107,632.00
\$8.50	75,935.00	79,173.00	82,238.00	85,642.00	87,536.00

^a250 crop acres with maximum of 50 percent in corn, hay crop is mixed mainly legume, 100 cows with either 13,000 or 16,000 pounds milk sold per cow without bGH.

similar to the forage only farm with no surplus forage, forage purchases would be required with bGH. Many managers consider purchasing forage as an undesirable option.

With stable milk prices, return over variable costs to the representative farms increase 5 to 26 percent depending on farm characteristics and response rate. The return over variable cost per cow increases with response rate, is greater for higher base production, is greater with the enhanced intake assumption, and is greater for the crop sales representative farm. The shadow prices or marginal values are generally constant on land and associated machinery and increasing on cows and buildings.

Table 36

RETURN OVER VARIABLE COST ON CROP SALES REPRESENTATIVE FARM
FOR SELECTED MILK PRICE AND RESPONSE LEVELS^a

Milk Price/CWT	No bGH	6.4% Response	12.8% Response	19.2% Response	25.6% Response
13,000# Base Herd Production Average					
\$12.69	137,852.00	144,703.00	151,481.00	158,446.00	164,719.00
\$11.50	122,382.00	128,243.00	134,030.00	140,006.00	145,288.00
\$10.50	109,382.00	114,431.00	119,366.00	124,510.00	128,960.00
\$9.50	96,382.00	100,579.00	104,702.00	109,014.00	112,632.00
\$8.50	83,382.00	86,747.00	90,038.00	93,518.00	96,304.00
16,000# Base Herd Production Average					
\$12.69	161,981.00	170,695.00	178,459.00	186,933.00	194,145.00
\$11.50	142,941.00	150,436.00	157,010.00	164,237.00	170,249.00
\$10.50	126,941.00	133,412.00	138,986.00	145,165.00	150,153.00
\$9.50	110,941.00	116,388.00	120,962.00	126,093.00	130,057.00
\$8.50	94,941.00	99,364.00	102,938.00	107,021.00	109,961.00

^a400 crop acres with maximum of 62.5 percent in corn, hay crop is mixed mainly legume, 100 cows with either 13,000 or 16,000 pounds milk sold per cow without bGH.

As aggregate production responds to bGH administration, milk price will fall reducing or erasing the short-term increase in returns. The financial position of individual farms after these adjustments will depend on the ability to actually achieve response to bGH, the success of feeding management strategies to increase intake, the current financial position and use of short-term returns from bGH, and the economic and political environment of the industry.

Figure 7: IMPACTS OF MILK MARKET PRICES ON RETURN OVER VARIABLE COSTS AND FARM RETURNS FOR REPRESENTATIVE FARMS AT 19.2 PERCENT bGH PRODUCTION RESPONSE (13,000 Base Production)

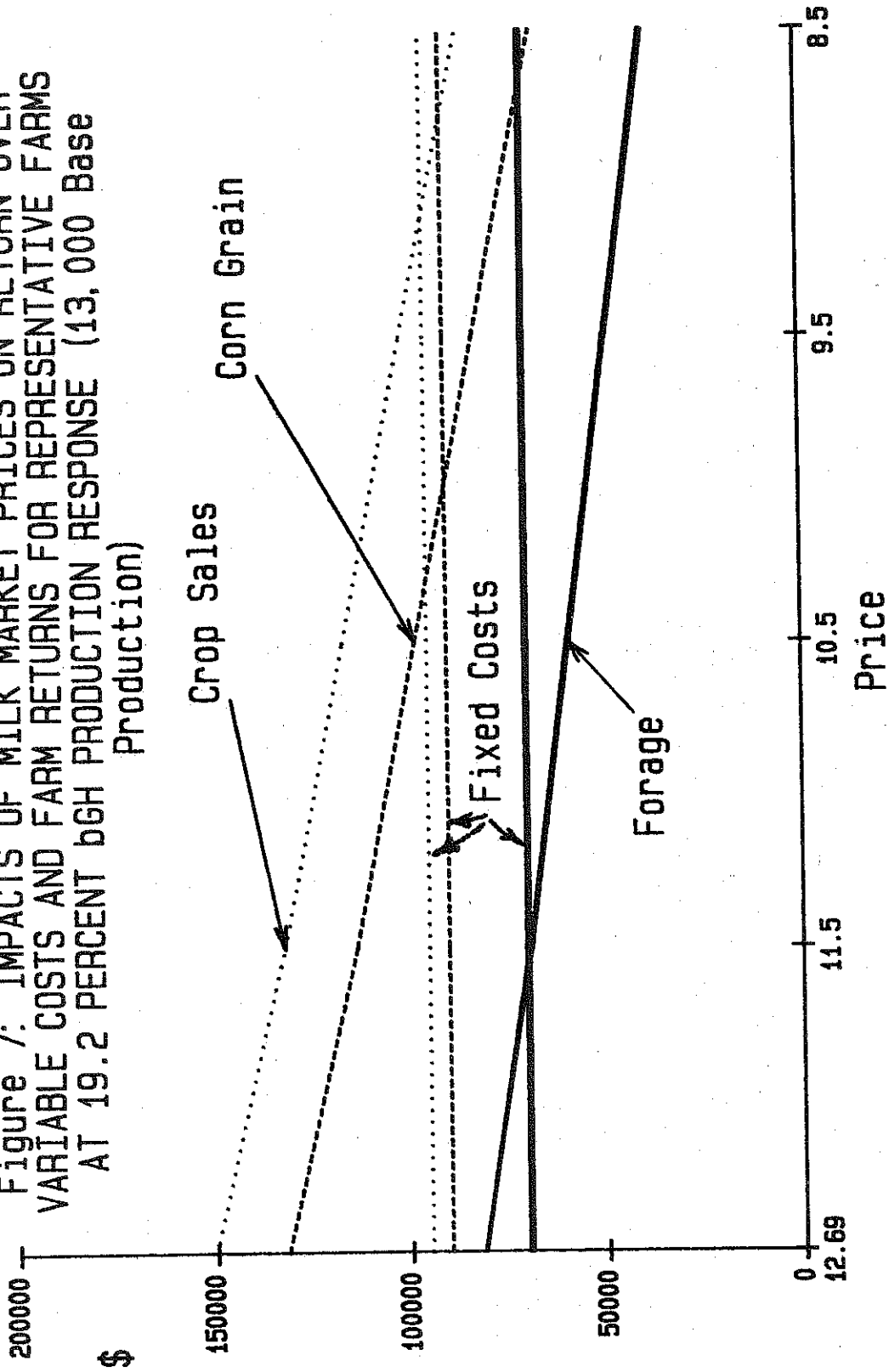
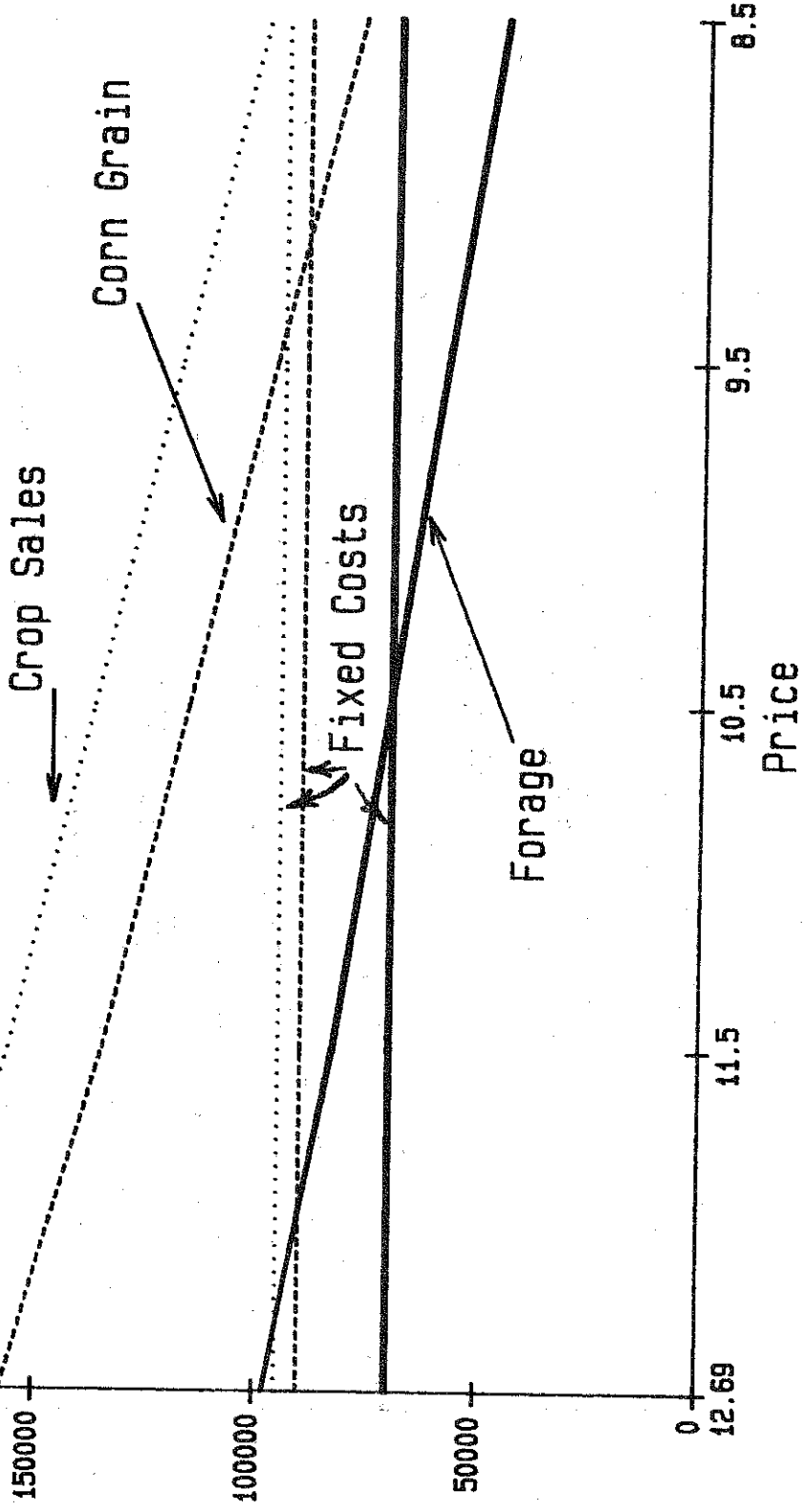

Figure 8: IMPACTS OF MILK MARKET PRICES ON RETURN OVER VARIABLE COSTS AND FARM RETURNS FOR REPRESENTATIVE FARMS AT 19.2 PERCENT bGH PRODUCTION RESPONSE (16,000 Base Production)



Section IV

BOVINE GROWTH HORMONE: THE ADOPTION ISSUE

Farmers are not novices regarding technological change. As the farm population has shrunk from 30 percent of the total in 1920 to a scant three percent today, farms have grown larger and more efficient as a result of technological change. Dairying, more immune to change because of its relative labor-intensive nature (as compared to crop enterprises), has nevertheless experienced a 100 percent increase in milk output per cow over the past score of years. Simultaneously, the number of dairy cows has declined by 50 percent (USDA, 1936, 1962, 1984).

But even with such a legacy of change, the technological advances promised by biotechnology research are noteworthy. Under this new biology, the rate of productivity change can be accelerated by levels of magnitude beyond that experienced to date. Milk production provides a relevant example. Traditional techniques including improved management and feeding practices combined with genetic advances have led to an average annual compounded increase in milk production of more than one percent per cow since the 1960's (USDA 1980). As discussed above, the daily injection of bovine growth hormone (bGH) beginning about the 90th day of lactation has been found to increase output by up to 40 percent! That level corresponds to a 25 percent increase over the entire lactation cycle (Bauman *et al.*, 1985). While the capacity of a new technology to stimulate milk production was recognized in the 1930's, it has been only since the advent of biotechnology that the compound could be produced at a level and cost making it economical for farm use (see Section II).

At the farm, regional and national levels such a rapid increase in productivity would have both beneficial and adverse implications. Given relatively static demand for milk and milk products, increases in production imply a reduction in consumer prices, declining national dairy farm numbers and the concomitant release of resources for alternative uses. For example, the maintenance feed requirements (roughly 30 percent of the ration) of the culled cows would be saved, a significant resource savings. Yet if the transition takes place too rapidly major dislocations will occur. With stable support prices and demand conditions, government stocks of surplus dairy products would jump at a high cost to the Federal Treasury. In the longer term prices must decline, accelerating the withdrawal of farms from the sector. Indirectly this could adversely impact some regions where employment, service industries and land values would also decline. Clearly the short term impacts of the rapid adoption of bGH could be harsh while a new equilibrium is reached.

A factor key to determining whether the adjustment to a new equilibrium will be rapid and difficult or gradual and smooth is the rate of acceptance of bGH by dairy farmers. Despite the impressiveness of the test results for bGH there are reasons to believe adoption would be more gradual than some expect. Historical experiences with other farm innovations suggest farmers may perceive obstacles to adoption that are not apparent to

outside observers. In order to facilitate planning for the dairy sector under the prospects of such major technological change, it is necessary to formulate expectations for the rate and extent of bGH adoption. The purpose of this Section is to explore issues related to the adoption of bGH and to provide an ex ante estimate of the rate of bGH adoption and its ceiling level of use.

The analysis begins with a review of the technological adoption and diffusion literature. As traditional analytic procedures are generally explanatory rather than predictive in nature, the section concludes with a discussion of a proposed predictive technique. Then, the approach taken for this study is detailed and the results enumerated. Finally, the results are used to develop a prediction of the future bGH market penetration.

DIFFUSION AND ADOPTION MODELS

Concern about technological change has led to a number of related analytical methods for explaining the rates of adoption and diffusion. According to the generally accepted terminology, adoption refers to individual decisions, while diffusion is the aggregated impact of those individual decisions. For both adoption and diffusion, the analytic approaches seen in the literature focus on an ex post explanation of the processes. Thus, while providing guidance concerning the diffusion patterns to be expected for a new innovation, the literature offers little in the way of precise formulations to assist in the prediction of future events.

Ex post studies of diffusion over time strongly suggest that cumulative adoption will follow an "S" shape or sigmoid distribution. Mathematically, these patterns have been described, with high levels of accuracy, by logistic functions. Logistic functions have the convenient property of tracking growth to some asymptote.¹

Griliches (1957) provided the first major application of the logistic curve to the study of technological change. In his study of hybrid corn, Griliches utilized the logistic function:

$$P = \frac{K}{1 + e^{-(a+bt)}} \quad (1)$$

where P = the level of diffusion
 K = the maximum level of diffusion (asymptote)
 a = a constant
 b = the rate of "acceptance"
 t = time in years.

¹In these formulations, if the percentage level of adoption at time t is given by Y_t , explanatory variables include a value for the maximum level of diffusion, K, and either Y_{t-1} , $1 - Y_{t-1}$ or both Y_{t-1} and $1 - Y_{t-1}$.

Equation (1) can be estimated using ordinary least squares by converting to the following form:

$$\log\left(\frac{P}{K-P}\right) = a + bt + \varepsilon \quad (2)$$

where ε is a randomly distributed error term.

In order to calculate estimates of a and b , Griliches first estimated values for K through visual inspection of plotted data collected from 31 states and 132 crop reporting districts. He then sought to explain differences in the parameters a and b for each region.²

Work by Mansfield (1968), Fischer and Pry (1971), and Blackman (1974) has employed similar approaches to the ex post study of innovation diffusion. These models, in which both the level of diffusion and the difference between that level and a ceiling determine the time path of diffusion, have been labeled by Lilien and Kolter (1983) as imitation models. They contrast these with innovation models. The term "imitation" stems from the specific marketing use of this model, where the influence of an already "converted" fraction of the market on the adoption rate is interpreted as the imitation effect. Under this model, then, adopters are assumed to be swayed by word-of-mouth interaction from prior adopters or by the example those users set.

In contrast to the imitation model, the innovation model postulates that the rate of diffusion is determined only by the proportion of the market not having adopted the product. Under this assumption, adopters are not influenced by prior users, but only by external stimuli such as advertising. Innovation models take the general form

$$\frac{dY_t}{dt} = p(1 - Y_t) \quad (3)$$

where p is defined as the coefficient of innovation. Innovation models have been estimated by Fourt and Woodlock (1960) and others. A combined innovation-imitation model was used by Bass (1969) of the form

$$Y_t = P(1 - Y_t) + q Y_t(1 - Y_t) \quad (4)$$

²Griliches arbitrarily defines the "date of origin" of the hybrid corn innovation as the year (relative to 1940) when 10 percent of the corn acreage in a particular region was planted with hybrid seed. This is calculated by assuming a ceiling of approximately 100 percent so that:

$$\log \frac{.10}{1.00 - .10} = \hat{a} + \hat{b}t \quad (.10) \quad (2')$$

Solving for t (.10);

$$\frac{-2.2 - \hat{a}}{\hat{b}} = t \quad (.10)$$

where $\hat{}$ indicates a least squares estimate. While the 10 percent level was arbitrary it is used merely as a means of ordering regions by date of adoption. Griliches found that he was able to explain, with a high degree of confidence, both the "date of origin" and the rate of acceptance.

where q is the coefficient of imitation. Finally, Easingwood et al. (1983) proposed a "Nonuniform Influence Model," which allows relaxing the implicit assumption that the diffusion curve be symmetrical. Symmetry in the composite model further implies that the adoption rate is maximized when market penetration reaches 50 percent. In practice the adoption rate frequently reaches its maximum level before the 50 percent level is achieved (Easingwood et al., 1980, pp. 275, 281).

While all these models have been useful in describing ex post the diffusion of innovation, they are severely limited with respect to ex ante prediction. When attempted, the new product is generally a close substitute for an existing good and the maximum market share to be taken has been estimated, or the projection is made after a product has been partially adopted, often in excess of 50 percent (Bass 1969, p. 226; Jarvis 1981, p. 496). Jarvis, for example, estimated both the rate of acceptance and the ceiling with data from the early stages of improved pasture diffusion in Uruguay. He repeatedly estimated equation 2 with various assumed ceilings and selected the equation with the best fit (R^2) to represent the diffusion rate. For a wholly new product such as bGH neither of these special cases applies.

While diffusion models are useful for understanding the aggregate process of technological change, they provide little ex ante insight into the likely rate of the adoption of particular innovations. For this, it is helpful to draw upon hypotheses from the adoption of innovation literature. Rogers (1962) in summarizing this literature suggests five dimensions (relative advantage, compatibility, complexity, divisibility, communicability) which determine the rate and likelihood of adoption. Rogers' analysis, along with the more quantitative work by Griliches, emphasizes that adoption decisions in aggregate depend on both sociological and economic factors. At the level of personal decision-making, it is generally accepted that there are individual characteristics which make some more likely to adopt innovations than others (Rahm and Huffman 1984). Both areas are investigated in the present study.

With respect to the features of innovations, Rogers' notion of relative advantage relates to the extent to which a new technique or product is preferred to the existing technology. Generally, the superiority of an innovation is measured by its profitability or risk-reducing potential.

Compatibility is the extent to which a new innovation is consistent with the existing norms, values and prior experience of prospective adopters. Also to be considered is the extent to which it is compatible physically and managerially with existing practices.

Complexity is the extent to which new techniques and their consequences are easy or difficult to understand. In general, researchers such as Kivlin (1960) and Graham (1956) have found that less complex ideas are more quickly and widely adopted.

Divisibility is the extent to which an innovation can be tested on a limited basis. The importance of divisibility stems from the risks

potentially involved in trying a new innovation. If trials can be done on a limited basis, earlier adopters, especially, are able to limit their exposure to losses.

Finally, Rogers lists communicability as the ease with which knowledge of an innovation can be passed along to potential users. This concept incorporates both the complexity of the incorporation as well as the rapidity and tangibility of benefits.

Recent work by Agriculture Canada (1984) on the adoption of six production level innovations employed a slightly different taxonomy of how product characteristics influence adoption. According to Agriculture Canada (pp. 44-45) important issues are the innovation's age, the initial investment required by the adoption decision and the riskiness of the undertaking. Three other factors, complexity, divisibility, and profitability, are very similar to those described by Rogers.

Applying the same procedures used by Agriculture Canada to bGH results in an adoption scenario comparable to experiences with granular treflan, a pre-emergence herbicide. Based on that comparison bGH can be expected to have rapid adoption to a medium/high level of acceptance. This projection is not based on a detailed analysis, but it does provide a basis for evaluating our survey results.

APPLYING DIFFUSION MODELS TO bGH

Predicting the rates of adoption and diffusion for an entirely new product such as bGH is necessarily a speculative exercise. The only relevant source of information is the judgment of potential users, in this case dairymen. The problem of obtaining useful indications of an innovation's attractiveness consists both of communicating the innovation's potential advantages and disadvantages as well as eliciting meaningful reactions from potential users. For generating a prediction of dairy farmers' response to bGH, a survey procedure was developed that involved both these elements.

In collaboration with dairy science researchers at Cornell University, a hypothetical Cooperative Extension "Fact Sheet" on bGH and fictitious advertisement from a well-known dairy publication for bGH (see Appendix AB) were prepared. These documents reflected the most up-to-date information available on bGH including production responses, costs, and overall effects on animal health. An attempt was made to present the material in a format similar to what might actually be used when bGH is first marketed and one which was brief but interesting.

Responses from farmers were collected using a questionnaire (Appendix AB) applied to a randomly selected sample of New York State dairy farmers. Because of the speculative nature of the questions being asked, we were particularly concerned with the consistency and thoughtfulness of an individual's responses. To ensure that the responses we used in projecting diffusion were the best we could obtain, we used an approach based on "decision calculus" to design the survey instrument. Decision calculus, developed to assist in strategic decisionmaking situations (Little, 1970;

Parasuraman and Day, 1977), specifically utilizes replications to lead decisionmakers to evaluate and refine their subjective judgments. Applications of decision calculus typically involve the use of an interactive computer program. Decisionmakers specify their estimates of outcomes from making relatively extreme decisions. The computer interpolates and offers an estimate of the outcome of less extreme decisions. The decisionmaker compares the model-based outcome with his subjective estimate and revises the midpoint estimate or his own extreme values appropriately. As the procedure continues iteratively, the decisionmaker is led to a precisely stated version of his subjective impression of a decision situation.

In the current study, it was impractical to rely upon a computer-based procedure because of the need to obtain a large sample of respondents. Instead, the questionnaire used here was designed to request repeatedly, in slightly different forms, the farmer's judgment about bGH. For example, early questions requested the respondent to assess the feasibility of bGH for his/her operation and then to estimate the length of time necessary before he/she would first try the product. Subsequent questions probed the farmer's opinions and, by intention, promoted reconsideration of initial opinions. These questions included the farmer's reaction to various price levels of bGH and possible changes in farm operations and resources necessary for the successful administration of bGH. Finally, the questioning returned to requesting specific estimates of the number of cows to be treated with bGH at specific times in the future.

DATA COLLECTION PROCEDURES AND SURVEY RESULTS

The complexity of the data collection procedure necessitated that respondents' reactions were thoroughly understood. This was especially important because the production responses expected from bGH use are beyond the levels previously experienced. This evaluation was done through a personal interview procedure conducted in seven New York counties in July and August, 1984. The counties were chosen by dairy extension specialists as representative of the diverse farming environment across New York State.³ Ten randomly selected dairymen in each county were contacted and an interview schedule set. Copies of the information materials and questionnaire were sent a week prior to the interview and subsequently completed by the enumerator. Additional information and comments were collected at the same time. Time and scheduling problems limited the number of interviews in each county to between five and seven for a total of 40 personal interviews.

An additional mailing to 1,025 New York dairymen (out of 17,236 total) was made in September, 1984. The random sample, which constitutes a rate of six percent for the State, was drawn from the "Ring List" maintained by the New York State Department of Agriculture and Markets. By law, ring tests must be made on all milk cows four times annually and the results recorded. The Ring List thus represents a virtually complete and up-to-date mailing list for sampling purposes. Dairy farms are listed by county, but no record is available on herd size or production level. Thus only a simple random sampling procedure could be used.

³The counties are Madison, Washington, St. Lawrence, Jefferson, Wyoming, Ontario and Delaware.

Of the 1,025 questionnaires sent, 14 were returned as undeliverable along with 133 usable returns (13 percent). The combined sample is then 173, or one percent of New York dairy farms in 1984. This response rate, while not unusually low, does raise questions about the possible selectiveness of the respondents. We analyzed this question by comparing mail and in-person samples using two sample t-tests. No significant difference (at the five percent level) was recorded among age, barn type and herd average. Moreover, there was no significant difference between the two groups in when they would first try bGH or in judgments about the feasibility of the innovation (Table 37). As a further comparison, a recent (1984) survey of dairy housing and milking systems throughout the Northeast was used (Heslop, unpublished data). The Heslop survey results with respect to housing and milking systems closely matched those obtained for this research. Based on these factors, we consider the survey results to be reflective of the attitudes of dairymen in New York State. The characteristics of surveyed farms and farmers are summarized in Table 38.

Survey Responses

Responses to the principal survey questions are summarized below.

Feasibility. Respondents were asked to assess the feasibility of bGH for their herds as "very," "somewhat," "possible," "questionable," or "other." A plurality (61 percent) was at least somewhat favorably inclined to adoption (Table 39).

Date to First Trial. Respondents were asked how soon after commercial availability they first expected to use bGH. Two-thirds anticipated initiating treatment within the first year with over a quarter planning immediate adoption. Conversely, one-eighth of the sample has no expectation of ever using the compound (Table 40).

Of those who would try bGH in their herds, the majority (73 percent) said they would experiment first by treating only a portion of their herd. Farmers would generally select test cows randomly and would not favor high or low producers. The gradual introduction is related to the individual operator's wish to gauge the impact of bGH on his/her operation prior to beginning full-scale use. The ability to test bGH on a portion of a herd is an example of the way in which the divisibility of the innovation facilitates adoption. Correlation of date to first trial and assessment of feasibility suggested high levels of consistency across the questionnaire. In fact, 21 percent of respondents rated compound use as very feasible while 27 percent planned to adopt immediately.

Price Response. In the material presented to farmers, the expected price of bGH was pegged at \$.17 per daily dose. Also provided was an indication of the range of incremental milk production that could be expected based on available experimental results. At all levels shown, and at all recent historical milk prices, the value of additional milk output far outweighed direct product cost. Nonetheless, when asked if an increase in the price of bGH to \$.25 per dose would affect their adoption decision, 47 percent responded that they would be less likely to try the product. A decrease to \$.10 per dose would increase the likelihood of trial for 40 percent of the

Table 37

COMPARISON OF IN-PERSON AND MAIL SURVEY RESPONSES¹

	Number	Age (years)	Product Per Cow (lbs)	(Mean) Herd Size	Assessment of Feasibility (1 = extremely feasible 5 = questionable)	Time of First Trial (yrs. from availability)
In-Person	40	45.2 (10.6)	15,445 (2,702)	68.4 (41.7)	2.7 (1.2)	1.16 (1.6)
Mail	133	46.9 (10.92)	16,052 (2,388)	67.8 (46.7)	2.9 (1.3)	0.82 (1.09)
Total	173	46.6 (10.92)	15,885 (2,474)	67.9 (45.4)	2.8 (1.3)	.91 (1.24)
All New York Dairy Farms ²	17,236	n.a.	n.a.	n.a.	n.a.	n.a.
All New York State Farms ²	42,207	50.1	n.a.	n.a.	n.a.	n.a.

¹Number in parenthesis is standard deviation.

²Stanton and Knoblauch, 1984.

Source: Survey data, unless otherwise specified.

Table 38
 SELECTED CHARACTERISTICS OF RESPONDENT FARMS
 NEW YORK, 1984

Characteristic	Percent/Respondents	
Barn Type	Stanchion	63
	Free Stall	23
	Other (inc. Combination)	14
Milking System	Bucket	7
	Pumping Station	18
	Pipeline	50
	Herringbone Parlor	21
	Other Parlor	4
Herd Average (lbs.)	< 13,500	13
	13,500-15,900	31
	15,901-17,800	38
	> 17,800	18
Age of Farmer (years)	< 35	16
	36-50	45
	51-60	28
	> 60	11

Source: Survey results

Table 39
 PERCEIVED FEASIBILITY OF bGH USE BY
 NEW YORK DAIRYMEN, 1984

Choice	Percent/Response
Very feasible	21
Somewhat feasible	18
Possible	22
Questionable	34
Other	5

Source: Survey results

Table 40
 EXPECTED TIME TO FIRST bGH TRIAL BY
 NEW YORK DAIRYMEN, 1984

Initiation Date	Percent/Respondents
Immediately upon availability	27
3 months after availability	12
6 months after availability	10
1 year after availability	17
2 years after availability	5
3 years after availability	5
4 years after availability	4
Later than 5 years	5
Never	13
Other, No Response	2

Source: Survey results.

respondents. Fifty-three percent and 60 percent, respectively, of respondents would not have the probability of trial changed by an increase or decrease in price.

The response by a large proportion of dairymen to the question regarding a 25 percent increase in the compound cost appears irrational when compared to its potential contribution to profitability. The answers may indeed be invalid because most respondents probably did not take the time to prepare a profitability analysis. Nevertheless, at the level of a "gut reaction," many farmers are apparently quite price sensitive. This sensitivity appears related to outward cash flow rather than to a more thorough evaluation of net benefits.

Herd Responses. For a given level of adoption numerous other factors affect the aggregate supply response. These include management, proportion of mature vs. first calf heifers, and herd size. As a means of gauging the impact of bGH on herd expansion plans, respondents were asked, for the next

one and five years, their (a) present plans for expansion or contraction and (b) additional changes which might be made as a result of bGH use. Without bGH the average planned increase in cow numbers was reported as 19.6 over the next five years. Since many farmers have in recent years expanded their milking herd to maintain cash flow with declining prices, farmers could use the higher output-per-cow potential of bGH as an opportunity for adjusting herd numbers. However, no significant impact was recorded, and we are unable to reject the null hypothesis that herd adjustment plans will be unaffected by the availability of bGH.

Farmers were further asked how they would satisfy additional feed requirements, particularly for energy, but most did not give a meaningful response. Thus we have no basis for projecting that cow numbers will fall voluntarily with the advent of bGH. The implication is for additional feed purchases, at least in the short run, although many farmers indicated that they could and would supply their own additional feed requirements.

Other Factors

Concerns about the respondents' comprehension of the survey were minimized by the written comments included on the mailed forms. These comments indicated a high level of understanding of the survey purpose and of the product. One frequent comment received was an expressed concern about the acceptability of bGH to DHIC (Dairy Herd Improvement Coop) and related testing programs. This factor seems to have an impact on adoption rate and could have important policy implications.

Farmers also questioned the practicality and desirability of daily injections. This is also reflected (see below) in a more positive response to an implant method of administration. Concern over injections is based on the operational difficulties of managing the injection of animals as well as its humaneness. Several respondents noted that even without bGH substantial improvements in milk output are possible. Increases, the comments emphasized, could also be obtained from improved management, the use of genetically superior animals, and other familiar technologies.

Farmers expressed an acute awareness of the potential of increased milk output to further depress milk prices. Some farmers, in fact, questioned the desirability of bGH being made available given market conditions, one farmer writing, "It should be outlawed." Others noted that if other farmers used bGH they would, practically, have no option but to adopt as well.

Finally, there was a variety of comments questioning the ethics of applying bGH. These included concern about possible health effects on animals and humans, reflecting a preference for "natural" means of increasing milk output. Indeed the possible negative impacts of bGH use given current knowledge were emphasized in the "Fact Sheet". The cautionary notes were expressed as "while the results to date are all very positive, it is important to remember that no long-term commercial herd applications have not been tried," and "Information on the long-term effects over multiple lactation cycles nevertheless is incomplete at this time." Any concerns were

clearly outweighed by the generally positive reaction to bGH but the incomplete information on health and safety available at the time of the survey could have depressed adoption rates somewhat.

Identifying Fast Adopters

We attempted to relate characteristics of farmers and their farms with their interest in adopting bGH. The characteristics studied were barn type, milking system, herd size, average herd production and age of operator. Farmers were classified as early, middle and late adopters, according to the length of time they would wait before trying bGH. Of the total sample, 89 percent provided sufficient information on both farm characteristics and adoption expectations to use for this analysis. Early adopters were classified as those who would try bGH within one year of availability. Middle adopters would try bGH between 1 and 5 years after its availability, and late adopters would wait more than 5 years or said they would never try bGH. About two-thirds of the sample was classified as early adopters with the rest split between middle and late adopters.

We used analysis of variance to test for differences among the adopter categories with respect to ages of the operator, herd size and average production. We expected that younger farmers would appear more innovative. This could result from inexperience, need, or looser bounds of tradition. The survey results do show an age-related factor. Early adopters were slightly younger than both middle and late adopters (mean age of 45.5 years versus 49.1 and 48.0 years, respectively). However, the statistical evidence is not strong, with significance at only the 25 percent level. Average production per cow also varies among adopter categories. Early and late adopters tend to have higher levels of output per animal than middle adopters but the differences are not statistically significant. This could in part be explained by the large variance within the high producer group due to greater innovativeness among some high producers while others display concerns for high value animals.

Giving reasonable significance (10 percent) is average herd size. Larger herds are indicative of better managers, who can be expected to be more innovative and greater risk takers. The expected pattern developed with early and middle adopters having significantly larger herds than late adopters (mean herd size of 72 and 70 for early and middle adopters versus 49 for late adopters (Table 41)).¹

Analysis of variance could not be used to test for differences among adopter categories on the basis of geography, barn type or milking system because of the categorical nature of the variables. Instead, we conducted a chi-square test for association. We anticipated that increased requirements for energy in the ration of treated cows would make bGH relatively more attractive to farmers in the west central region as compared to farmers in the heavy, poorly drained soils of Northeastern New York. However, this was not supported by survey results, which did not show any differences in the average starting date among regions. Similarly, milking

¹For a discussion of the relationship between farm size and the acquisition on new technology see Feder and Slade (1984).

Table 41

RELATIONSHIP OF YEAR OF FIRST bGH TRIAL AND AVERAGE HERD SIZE
NEW YORK DAIRYMEN, 1984

Adoption Rate ^a			
	Early	Mid-term	Late
Number Responses	106	22	26
Herd Size/Mean	72.43	70.05	49.46
Herd Size/S.D.	47.84	55.84	17.89

Analysis of Variance			
Source	Factor	Error	Total
Degrees of Freedom	2	151	153
Sum of Squares	11,104	313,841	324,946
Mean Square	5,552	2,078	
F	2.67		

^aAdoption rates are defined as follows: early, < 1 year after availability; mid-term, 1-5 years after availability; late, > 5 years or never.

Source: Survey results

system did not provide a statistically significant means of distinguishing between adopter categories.

Barn type, however, is significantly associated with adopter category. Barns were classified as "stanchion" or "other," the latter including mostly free stall as well as combinations. Early adopters were significantly more likely to have free stall or combination barns. Seventy-five percent of farmers having free stalls or combinations were early adopters versus only 62 percent of stanchion barn owners (Table 42). There is some question whether this variable reflects innovativeness of farmers or greater ease of administration (compatibility). According to dairy extension specialists there is no clear advantage for one system over the other of administering the daily injections. The general feeling is that barn type

Table 42

DISTRIBUTION OF DAIRY FARMS BY ADOPTER RATE AND BARN TYPE
New York Dairymen, 1984

Barn Type	Adoption Rate ^a			Number of Responses
	Early	Mid-term	Late	
Stanchion %	62	14	24	98
Other %	77	16	7	57
Total %	68	15	17	155

^aFor definition of categories, see Table 41.

Source: Survey results.

reflects the innovativeness of the operator with more progressive farmers using free stall systems.

The two statistically significant factors, average herd size and barn type, provide a basis for projecting adoption decisions to populations other than New York State dairy farmers. However, further analysis is required before such a projection can be made with confidence.

PROJECTION OF DIFFUSION RATES

Potential diffusion rates are projected based on responses to the question, "Overall, how many cows in your herd would you expect to be using the hormone in:....." (Question 12, Appendix AB). Respondents were then given a list beginning with six months and progressing to 10 years. The mail survey asked for separate responses for injections and implants as administrative methods. The in-person survey was limited to injections only as an administration technique. Otherwise the surveys were identical.

A number of approaches can be taken to analyzing the response to Question 12 depending on how the surveys were completed. In several cases, respondents did not provide information on planned bGH use in all the time periods indicated. This required either dropping the response from the sample altogether or imputing some rate of change in cows on treatment for the excluded years. Additionally, while most respondents increased the number of cows on treatment over time to their entire herd size, some indicated that they would level off, with only a portion on treatment by

the tenth year. Based on available information on the bGH program, it seems highly unlikely that only portions of a herd would be treated, except during a trial period.

Consequently, we have calculated diffusion rates in three ways:

- o By including all responses and assuming that partially specified time paths would continue unchanged for the balance of the ten year period (e.g. if a respondent indicated that he/she would treat 25 percent of the herd during the first six months, 50 percent by the end of the first year and gave no response for years 2-10, a treatment rate of 50 percent was assumed throughout).
- o By deleting all responses that did not completely specify treatment rates for the entire time period, six months through 10 years.
- o By including only responses which showed non-adoption or reached 100 percent herd treatment by the tenth year.

Table 43 gives an example of the three procedures. The procedure was applied twice, once for injections and once for implants.

The first data treatment above is questionable and is not expected to relate well to actual adoption rates and levels. The second and third treatments differ by the validity of the judgment that dairymen will not, in the long term, maintain only a portion of the herd on treatment. Rather than attempting to justify one choice or another, we present both with the expectation that they will bracket the actual experience. Appendix AC contains the data values for injections and implants, respectively.

Table 43

DATA TREATMENTS FOR COMPUTING ADOPTION RATES
(percent of herd on treatment)

Respondent/Year						Included in Data Set Treatment		
6 mo	1 yr	2 yr	3 yr	5 yr	10 yr	all respondents	complete responses	partial adoption excluded
10	20	30				X		
10	20	30	50	50	50	X	X	
10	20	30	50	80	100	X	X	X
0	0	0	0	0	0	X	X	X

The declining sample size demonstrates the increasing selectivity when moving from the first treatment to the third. Based on these results, adoption always exceeds 40 percent by the end of the first year, with long term (10 year) penetration ranging from 55 to 90 percent depending on the data compilation method and administration technique used. These figures are summarized in Figures 9 and 10 for injections and implants respectively. As can be seen, the availability of implants would both accelerate the adoption process and raise the long term penetration level.

Estimating Diffusion Functions

As indicated above, previous research suggests that the diffusion of bGH can be expected to follow an "S" pattern. This is confirmed by visual examination of Figures 9 and 10. Of particular interest for this research is the rate of innovation and the ultimate level of adoption. Unfortunately, the conventional estimating form of the logistic (equation 1) requires an *a priori* estimate of that ceiling level. Jarvis, as noted, employed sensitivity analysis to select the ceiling level most consistent with existing data. In this research we employed an alternative formulation of the logistic function suggested by Pindyck and Rubinfeld (1981).

They note that the solution to the differential equation:

$$\frac{dy}{dt} = \alpha y(\beta - y) \quad (5)$$

has the form of equation 1. The discrete approximation to equation 5:

$$\frac{\Delta Y_t}{Y_{t-1}} = \gamma + \delta Y_{t-1} + \varepsilon \quad (6)$$

can be estimated using ordinary least squares. In addition equation 6 provides a simple method of estimating the ceiling level of diffusion. Setting Y_t in equation 6 equal to zero the asymptote is simply:⁴

$$-\frac{\hat{\gamma}}{\hat{\delta}} = Y_{t-1} \quad (7)$$

⁴The level of diffusion at any point in time must then be calculated backward from the asymptote. Choose some Y_t approximately equal to the asymptote. Rewriting equation 6 we have:

$$0 = \hat{\delta} Y_{t-1}^2 + (1 + \hat{\gamma})Y_{t-1} + Y_t \quad (8)$$

Equation 8 can be solved iteratively using the quadratic formula to give a value for the level of diffusion in any previous periods.

In fact, this yields two solutions for Y_{t-1} , one approaching the asymptote from above and another from below. Only the value approaching the asymptote from below has significance in this context.

Figure 9: EXPECTED bGH ADOPTION WITH INJECTIONS

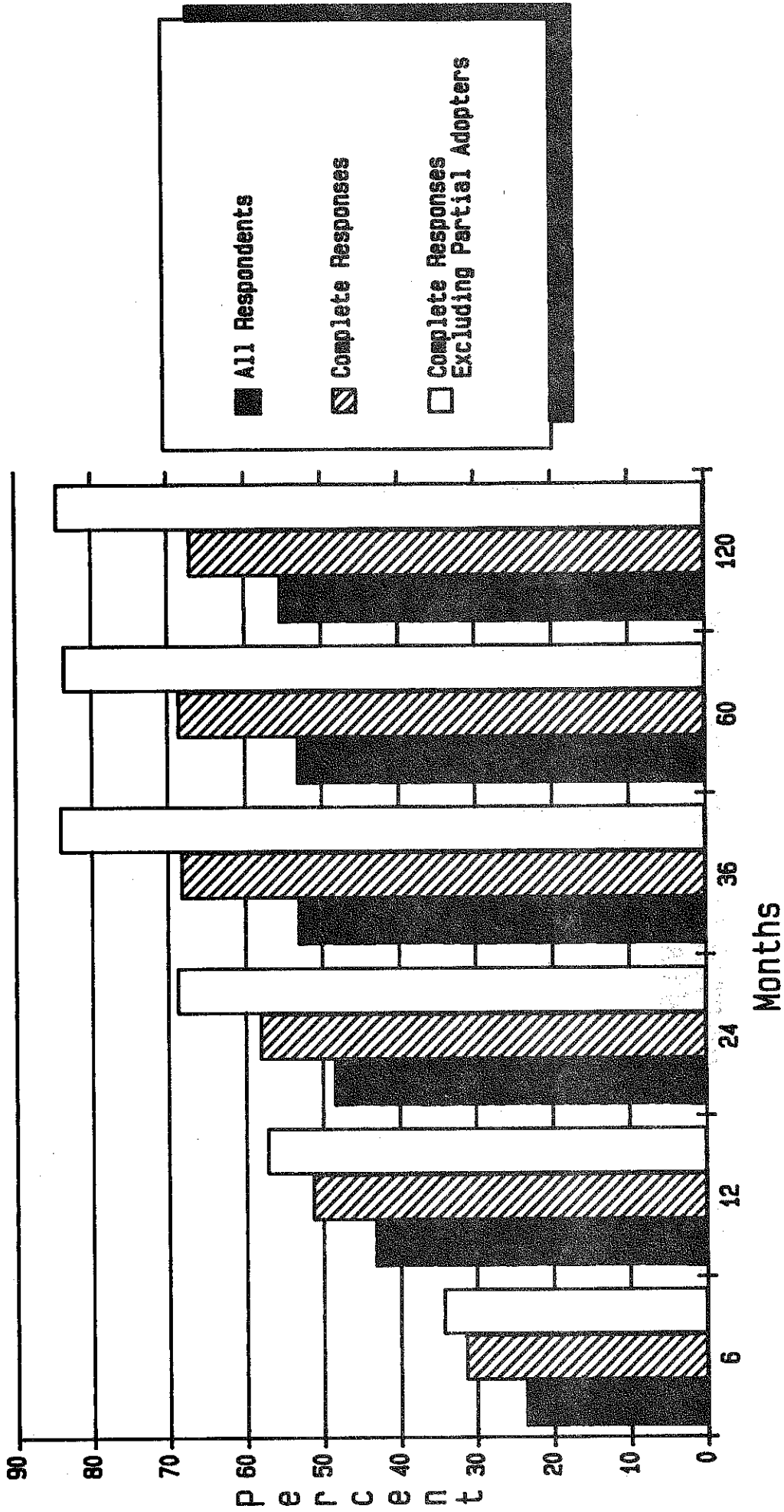
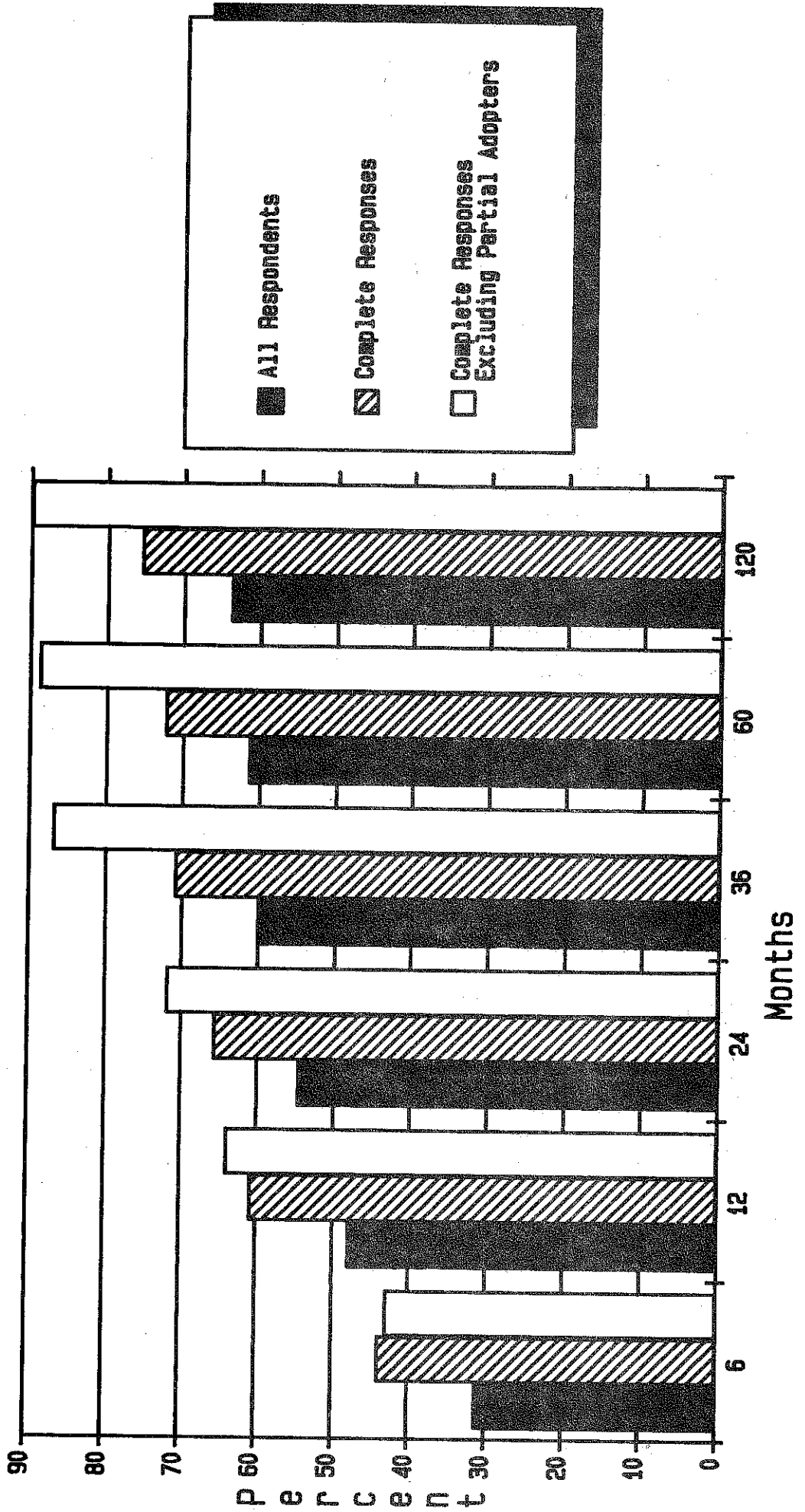

Figure 10: EXPECTED bGH ADOPTION WITH IMPLANTS



Least squares estimate of equations 6 and 7 is given in Table 44. As shown, the goodness of fit of estimated equations is good and coefficients are all statistically significant.⁵ As might be expected, rates of

Table 44
LOGISTIC DIFFUSION CURVE FITS TO bGH ADOPTION DATA
NEW YORK DAIRYMEN, 1984^a

Data Treatment	Intercept	Coefficient	R ²	Computed Asymptote
	Injection			
All Respondents	2.85 (6.89)	-5.59 (6.16)	90.2	51.2
Complete Responses	2.27 (5.79)	-3.61 (5.15)	86.4	62.9
Complete Responses Excluding Partial Adopters	1.97 (4.75)	-2.47 (4.06)	79.5	79.8
	Implant			
All Respondents	2.06 (5.82)	-3.51 (5.18)	86.6	58.7
Complete Responses	1.88 (5.91)	-2.70 (5.39)	90.6	69.6
Complete Responses Excluding Partial Adopters	1.65 (4.34)	-1.96 (3.75)	76.5	84.7

^aNote: t-statistics are in parentheses

Source: data from Appendix AC

⁵Note that the parameters are not directly comparable to those of Griliches.

diffusion and maximum levels of use are higher for implants than with injection application. Estimated asymptotes show levels in excess of 50 percent for all subsamples. Rejecting data treatment A as unrealistic leaves a minimum projected penetration of 63 percent.

SUMMARY AND CONCLUSIONS

The availability of bovine growth hormone, bGH, may produce important effects on the New York State dairy industry. The significance of these effects depends, in part, on the rate and extent to which farmers adopt the new innovation. This section examines issues related to the adoption and diffusion of bGH. In contrast to the received literature on diffusion and adoption, the focus of this research is developing ex ante estimates of adoption and diffusion.

The procedure involved providing to a sample of dairymen facts about the effects of the product, presented as an advertisement and Cooperative Extension "Fact Sheet." Respondents were then asked specific questions about their own plans based on the provided information. Despite the abstractness of the approach and the magnitude of the described production response, respondents during in-person interviews and through written comments showed a clear understanding of the purpose of the survey. Moreover, responses conformed to expectations and appeared on average reasonable and well-thought out.

A two-tiered sampling procedure was used, consisting of 40 personal interviews in seven representative dairy counties followed by a mail survey to 1,025 farmers during July-September 1984. The overall sample is 173, or about 1 percent of all New York dairy farms. The characteristics of respondents match closely State averages, suggesting that the sample is representative. Results show a relatively rapid adoption rate with at least half of the State herd on treatment within the first year of availability. The ceiling level of adoption of 63 to 85 percent, depending on the analysis procedure and administration techniques, is achieved by about the third year.

Our approach did not account for downward price effects of widespread use of bGH. Should bGH become widely used and prices allowed to adjust, it is unlikely that nonadopters could survive. Thus, in a dynamic environment we expect use of bGH to approach 100 percent.

Early adopters are characterized by higher herd production averages and use (primarily) of free stall barns. These factors provide a basis for projecting adoption rate outside New York, although further research is required to determine the relevant factors in those areas. Also requiring further analysis are the price effects of various rates of adoption and possible policies to manage the effects of rapid increases in milk supplies.

Section V

CONCLUSIONS

If approved by the Food and Drug Administration, bovine growth hormone is a viable commercial product for increasing milk production from dairy cows and improving short term dairy farm profitability. Production costs for the recombinantly derived hormone are low relative to other factor inputs and the marginal cost per hundredweight of additional milk produced ranges between 25 and 45 percent of the current price paid to farmers. This coupled with potential productivity increases which could reach 25 percent or higher with well managed herds provides the basis for rapid adoption of the product.

Surveys of New York dairymen indicate the strong probability of this rapid adoption and further suggest that large herds will most rapidly implement this new approach to increasing milk production. If, as indicated by survey results, 80 to 90 percent of the dairymen adopt within the first three years of market availability, unprecedented implications for farm management practices, milk markets and prices, and farm structure will follow.

At the dairy cow enterprise level, total feed requirements will increase although less than proportionately with production response. On a farm firm level, this will result in increased feed purchases and/or decrease crop sales. Depending on the feeding management program and production response by the animals being administered the hormone, requirements for concentrate will increase from 30 to 110 percent. As a result, crop rotations will change to accommodate the need for more nutrients. Overall, with stable milk prices, farm returns over variable costs increase 5 to 26 percent depending on farm characteristics and the response of animals to hormone administration. Increased farm returns result in higher marginal values (shadow prices) for cows and buildings but generally constant marginal values for land and associated machinery.

In the aggregate, as production increases due to the hormone, milk prices will fall reducing the short-term gain in farm returns. The number of dairymen and the size of the national dairy herd will, by necessity, decline as the market seeks a new equilibrium. The size of this adjustment and its timing will depend not only on the production response to bGH and the rate of adoption but on level and scope of government price support programs for milk. However, with the possibility of such a rapid and large production increase, many dairymen, in the three to five years after hormone introduction, will be placed in the position of obtaining returns over variable costs which are below their fixed costs of operation. Farms with low debt loads, good soil resources, and superior management will be better able to survive the transition. The financial position of individual farms after these adjustments will depend on the ability to actually achieve response to bGH, the success of feeding management strategies to increase intake, the current financial position and use of short-term returns from bGH, and the economic and political environment of the dairy industry.

REFERENCES

- Agriculture Canada, Regional Development Branch, "Technology Transfer in Agriculture: What It Is and How It Occurs." Ottawa, August 1984.
- Aplin, R. and G. Casler. Capital Investment Analysis. Columbus, Ohio: Grid, Inc. 1973.
- Bass, Frank M. "A New Product Growth Model for Consumer Durables," Management Science. 11(9): 215-227, 1969.
- Bauman, D.E., M.J. DeGeeter, C.J. Peel, G.M. Lanza, R.C. Gorewit and R.W. Hammond. "Effect of Recombinantly-Derived Bovine Growth Hormone (bGH) on Lactational Performance of High Yielding Dairy Cows." Journal of Dairy Science. 65(Supplement 1): 121, 1982a.
- Bauman, D.E., J.H. Eisemann and W.B. Currie. "Hormonal Effects on Partitioning of Nutrients for Tissue Growth: Role of Growth Hormone and Prolactin." Fed. Proc. 41: 2538, 1982b.
- Bauman, D.E., P.J. Eppard, M.J. DeGeeter, and G.M. Lanza. "Responses of High Producing Dairy Cows to Long Term Treatment With Pituitary- and Recombinant-Somatotropin." Journal of Dairy Science. 68: (in press) 1985.
- Bauman, D.E. and S.N. McCutcheon. "The Effects of Growth Hormone and Prolactin on Metabolism." In Proceedings of the VI International Symposium on Ruminant Physiology. A. Dobson, ed. Reston Publishing Co., Inc. (in press), 1985.
- Blackman, A. Wade. "The Market Dynamics of Technological Substitution," Technological Forecasting and Social Change. 6: 41-63, 1974.
- Chemical and Engineering News, (personal interview). December 24, 1984.
- Crop Reporting Board. Agricultural Prices, Annual Summary 1979. U.S. Department of Agriculture. Washington D.C., June 1980.
- _____. Agricultural Prices, Annual Summary 1980. U.S. Department of Agriculture. Washington D.C., June 1981.
- _____. Agricultural Prices, Annual Summary 1981. U.S. Department of Agriculture. Washington D.C., June 1982.
- Easingwood, C.J., V. Mahajan, and E. Muller. "A Non-uniform Influence Innovation Diffusion Model of New Product Acceptance," Marketing Science. 2(3): 273-295, 1983.
- Feder, Gushon, and Roger Slade. "The Acquisition of Information and the Adoption of New Technology," American Journal of Agricultural Economics 66: 512-520, 1984.

- Fisher, J.C. and R.H. Pry. "A Simple Substitution Model of Technological Change," Technological Forecasting and Social Change. 3:75-88, 1971.
- Fourt, L.A. and J.W. Woodlock. "Early Prediction of Market Success for New Grocery Products," Journal of Marketing. 1960, pp. 31-38.
- Fox, D.G. and C.J. Nowak. Feeding and Management Strategies for Producing Beef from Holstein Steers on Northeast Dairy Farms. Department of Agricultural Economics Staff paper 81-17. Cornell University, June 1981.
- Goeddel, D., H. Heyneker, T. Hozumi, R. Arentzen, K. Itakura, D. Yansura, M. Ross, G. Miozzari, R. Crea, and P. Seeburg. "Direct Expression in Escherichia coli of a DNA Sequence Coding for Human Growth Hormone." Nature 281: 544, 1979.
- Graham, S. "Class and Conservatism in the Adoption of Innovations," Human Relations. 9: 91-100, 1956.
- Griliches, Z. "Hybrid Corn: An Exploration in the Economics of Technological Change," Econometrica. 25: 501-22, 1957.
- Guthrie, K. and W. R. Grace & Co. "Data and Techniques for Preliminary...Capital Cost Estimating." Chemical Engineering. March 1969: 114-142.
- Henderson, J. and R. Quandt. Microeconomic Theory: A Mathematical Approach. 2nd ed. New York: McGraw-Hill Book Co. 1971.
- Heslop, E. Unpublished data. Department of Dairy Science, Cornell University.
- Howe, C. Benefit-Cost Analysis for System Planning. Water Resources Monograph 2. Baltimore: Publication Press, Inc. 1971.
- Jarvis, L.S. "Predicting the Diffusion of Improved Pastures in Uruguay," Am. J. Agr. Econ. 63: 495-502, 1981.
- Kalter, R.J. "Production Costs, Commercial Potential and the Economic Implications of Administering Bovine Growth Hormone." In Proceedings: 1984 Cornell Nutrition Conference for Feed Manufacturers. Syracuse, N.Y., Oct. 30-Nov. 1, 1984, pp. 27-41.
- Kalter, R., W. Tyner, T. Baker, and J. Broderick. GEN3--A Simulation Model For Resource Policy Evaluation. Department of Agricultural Economics Research paper 83-2. Cornell University, 1983.
- Kivlin, J.E. Characteristics of Farm Practices Associated with Rate of Adoption. Unpublished Ph.D. Dissertation, Pennsylvania State University, 1960.
- Knoblauch, W.A. "Dairy Cow Enterprise Budgets, Costs and Returns for 1981." Unpublished mimeo. Cornell University, 1981.

- Knoblauch, W.A. and R.A. Milligan. Economic Profiles for Corn, Hay and Pasture; 1980 and Five Year Average 1976-80. Department of Agricultural Economics Extension paper 81-23. Cornell University, October 1981.
- Knoblauch, W.A. and R.A. Milligan. Economic Profiles for Corn, Hay and Pasture; 1981 and Five Year Average 1977-1981. Department of Agricultural Economics Extension paper 82-31. Cornell University, October 1982.
- Krenz, R.D. "Farm Enterprise Data System (FEDS) Budgets, Northeast Region, 1980 and 1981." U.S.D.A. and Oklahoma State University.
- Lilien, S.L. and P. Kotler. Marketing Decision Making: A Model Building Approach. Ch. 19. New York: Harper and Row, 1983.
- Little, J.D.C. "Models and Managers: The Concept of a Decision Calculus," Management Science. 16: B-466-85 (1970).
- Mansfield, Edwin. Industrial Research and Technological Innovation. New York: Norton, 1968.
- Martial, J. "Structure and Expression of Growth Hormone Genes by Recombinant DNA Technology," in Peptides Structure and Function. Gross and Meienhofer, eds. 6th American Peptides Symposium, 1979.
- Meier, R., W. Newell, and H. Pazer. Simulation in Business and Economics. Englewood Cliffs, New Jersey: Prentice Hall, Inc., 1969.
- Miller, W.L., J.A. Martial and J.D. Baxter. "Molecular Cloning of DNA Complementary to Bovine Growth Hormone mRNA," Journal of Biological Chemistry. 255:7521 (1980).
- Milligan, R.A., L.E. Chase, C.J. Sniffen, and W.A. Knoblauch. Least Cost Balanced Dairy Rations, NEWPLAN Program 31 Form 6 Computer Program User's Manual. Department of Agricultural Economics Extension paper 81-24 and A.S. Mimeo 54. Cornell University, October 1981.
- Milligan, R.A. C.J. Nowak, and W.A. Knoblauch. Profitability of Feeding Dairy Steers to Feeder and Slaughter Weight on Northeast Dairy Farms. Department of Agricultural Economics Staff paper 81-16. Cornell University, June 1981.
- National Research Council. Nutrient Requirements of Dairy Cattle. 5th ed. National Academy of Sciences. Washington D.C., 1978.
- National Research Council. Nutrient Requirements of Domestic Animals. No. 3. National Academy of Sciences. Washington D.C., 1978.
- Oltenacu, P.A., H.R. Ainsle and J.F. Keown. "Projecting the Income From Milk Sales in a Dairy Enterprise." Journal of Dairy Science. 59: 1989-1996, 1976.

- Parasuraman, A. and R.L. Day. "A Management-Oriented Model for Allocating Sales Effort," J. Mkt. Res. XIV: 22-33 (1977).
- Peel, C.J., D.E. Bauman, R.C. Gorewit and C.J. Sniffen. "Effect of Exogenous Growth Hormone on Lactational Performance in High Yielding Dairy Cows." Journal of Nutritional. 111: 1662, 1981.
- Peel, C.J., L.D. Sandles, K.J. Quelch and A.C. Herington. "The Effects on Long Term Administration of Bovine Growth Hormone on the Lactational Performance of Identical Twin Dairy Cows." Animal Production. (in press), 1985.
- Peters, M. and K. Timmerhaus. Plant Design and Economics for Chemical Engineers. New York: McGraw-Hill Book Co., 1980.
- Pindyck, R.S. and D.J. Rubinfeld. Econometric Models and Economic Forecasts. New York: McGraw-Hill Book Co., 2nd ed., 1981.
- Rahm, M.R. and W.E. Huffman. "Adoption of Reduced Tillage," Am. J. Agr. Econ. 66: 405-13 (1984).
- Ramsey, R.S. "Optimal Forage Production, Harvesting, Allocating and Feedings Systems for Grouped Herds." Unpublished M.S. Thesis. Cornell University, May 1983.
- Rogers, E.M. Diffusion of Innovations. New York: The Free Press, 1962.
- Smith, S.F. and L.D. Putnam. Dairy Farm Management Business Summary, New York, 1981. Department of Agricultural Economics Research paper 83-32. Cornell University, September 1983.
- Sniffen, C.J. Personal Communications. 1982.
- Stanton, B.F., and W.A. Knoblauch. New York Agriculture and Census Data, 1982. Agricultural Extension Paper 84-21, Cornell University, July 1984.
- Tyrrell, H.F., A.C.G. Brown, P.J. Reynolds, G.L. Haaland, C.J. Peel, D.E. Bauman and W.D. Steinhour. "Effect of Growth Hormone on Utilization of Energy by Lactating Holstein Cows." Energy Metabolism of Farm Animals. A. Ekern and F. Sundstol, eds. European Association for Animal Production, Publication No. 29, 1982, p. 46.
- United States Congress, Office of Technology Assessment. Gasohol: A Technical Memorandum. Washington D.C., September 1979.
- U.S. Department of Agriculture. Fact Book of U.S. Agriculture. Miscellaneous Publication No. 1063 Washington: U.S. Department of Agriculture, 1980, p. 103.
- . Agricultural Statistics, U.S. Government Printing Office, Washington D.C., 1976, p. 259.
- . Agricultural Statistics, U.S. Government Printing Office, Washington D.C., 1983, p. 327.

Appendix A

MAJOR EQUIPMENT LIST
 bGH FERMENTATION PLANT
 (1/2 million cow daily capacity)

DESCRIPTION	DESIGN CONDITIONS	MATERIALS OF CONSTRUCTION	ESTIMATED TOTAL COST
Seed inoculum vessel 1 required	1500 l w/agitator	304 S.S.	\$ 12,473
Fermentors 3 required	60,000 l w/O ₂ , pH, foam, temp. controls and air incinerator	S.S.	3,115,719
Glass wool filter for air sterilization unit - 1 required	300 ft ³ /min.		73,500
Plate and frame filter 1 required	350 ft ²	304 S.S.	17,531
ATM suspended basket Centrifuges 3 required	10 Hp.	S.S.	116,411
Mixing vessels with agitator 2 required	900 l used 600 l req. vol.	S.S.	16,630
IMpandex cell rupture device w/glass beads 1 required	500 gal/hr.		93,450
Chromatography columns 16 required	30" dia. 3 ft. high	glass lined	133,042
Vessels 3 required	250 l	S.S.	11,305
Mixing vessel w/ agitator 1 required	250 l	S.S.	5,543
Displacement Pumps 11 required		S.S.	72,064
Total Equipment Cost			<u>\$3,667,668</u>

Appendix B

MAJOR EQUIPMENT LIST
 BGH FERMENTATION PLANT
 (1 million cow daily capacity)

DESCRIPTION	DESIGN CONDITIONS	MATERIALS OF CONSTRUCTION	ESTIMATED TOTAL COST
Seed inoculum vessel 1 required	1500 l w/agitator	304 S.S.	\$ 12,473
Fermentors 6 required	60,000 l w/ O ₂ , pH, foam, temp. controls and air incinerator	S.S.	6,231,436
Glass wool filter for air sterilization unit - 1 required	350 ft ³ /min.		89,250
Plate and frame filter 1 required	400 ft ²	304 S.S.	20,719
ATM suspended basket Centrifuges 3 required	10 Hp.	S.S.	116,411
Mixing vessels with agitator 2 required	900 l used 650 l req. vol.	S.S.	16,630
IMpandex cell rupture device w/glass beads 1 required	500 gal/hr.		93,450
Chromatography columns 16 required	30" dia. 3 ft. high	glass lined	133,042
Vessels 3 required	300 l	S.S.	11,641
Mixing vessel w/ agitator 1 required	300 l	S.S.	5,543
Displacement Pumps 11 required		S.S.	72,064
Total Equipment Cost			\$6,802,659

Appendix C

MAJOR EQUIPMENT LIST
bGH FERMENTATION PLANT
(2.5 million cow daily capacity)

DESCRIPTION	DESIGN CONDITIONS	MATERIALS OF CONSTRUCTION	ESTIMATED TOTAL COST
Seed inoculum vessel 1 required	2500 l w/agitator	304 S.S.	\$ 14,136
Fermentors 12 required	75,000 l w/ O ₂ , pH, foam, temp. controls and air incinerator	S.S.	13,774,754
Glass wool filter for air sterilization unit - 1 required	500 ft ³ /min.		105,000
Plate and frame filter 1 required	550 ft ²	304 S.S.	28,687
ATM suspended basket Centrifuges 3 required	10 Hp.	S.S.	116,411
Mixing vessels with agitator 2 required	900 l used 800 l req. vol.	S.S.	16,630
IMpandex cell rupture device w/glass beads 1 required	500 gal/hr.		93,450
Chromatography columns 16 required	30" dia. 3 ft. high	glass lined	133,042
Vessels 3 required	400 l	S.S.	12,474
Mixing vessel w/ agitator 1 required	400 l	S.S.	5,543
Displacement Pumps 11 required		S.S.	72,064
Total Equipment Cost			\$14,372,191

Appendix D

MAJOR EQUIPMENT LIST
bGH FERMENTATION PLANT
(3 million cow daily capacity)

DESCRIPTION	DESIGN CONDITIONS	MATERIALS OF CONSTRUCTION	ESTIMATED TOTAL COST
Seed inoculum vessel 1 required	2500 l w/agitator	304 S.S.	\$ 14,136
Fermentors 12 required	90,000 l w/ O ₂ , pH, foam, temp. controls and air incinerator	S.S.	15,086,635
Glass wool filter for air sterilization unit - 1 required	550 ft ³ /min.		120,750
Plate and frame filter 1 required	600 ft ²	304 S.S.	31,875
ATM suspended basket Centrifuges 3 required	10 Hp.	S.S.	116,411
Mixing vessels with agitator 2 required	900 l used 800 l req. vol.	S.S.	16,630
IMpandex cell rupture device w/glass beads 1 required	500 gal/hr.		93,450
Chromatography columns 16 required	36" dia. 3 ft. high	glass lined	166,302
Vessels-surge tank 1 required	450 l	S.S.	4,158
Vessel-buffer tank 1 required	450 l	S.S.	4,158
Vessel-fraction collector 1 required	450 l	S.S.	4,158
Vessel-final resuspension w/ agitator 1 required	450 l	S.S.	6,929

Appendix D

MAJOR EQUIPMENT LIST
bGH FERMENTATION PLANT
(3 million cow daily capacity)

DESCRIPTION	DESIGN CONDITIONS	MATERIALS OF CONSTRUCTION	ESTIMATED TOTAL COST
(Continued)			
Displacement Pumps 11 required		S.S.	75,761
			<hr/> <hr/>
Total Equipment Cost			\$15,741,353

Appendix E

MAJOR EQUIPMENT LIST
bGH FERMENTATION PLANT
(3.5 million cow daily capacity)

DESCRIPTION	DESIGN CONDITIONS	MATERIALS OF CONSTRUCTION	ESTIMATED TOTAL COST
Seed inoculum vessel 1 required	3000 l w/agitator	304 S.S.	\$ 19,402
Fermentors 15 required	84,000 l w/ O ₂ , pH, foam, temp. control and air incinerator	S.S.	15,578,591
Glass wool filter for air sterilization unit - 1 required	600 ft ³ /min.		136,500
Plate and frame filter 1 required	650 ft ²	304 S.S.	35,063
ATM suspended basket Centrifuges 3 required	20 Hp.	S.S.	166,302
Mixing vessels with agitator 2 required	900 l	S.S.	16,630
IMpandex cell rupture device w/glass beads 2 required	500 gal/hr.		186,900
Chromatography columns 16 required	36" dia. 3.5 ft. high	glass lined	194,019
Vessels-surge tank 1 required	500 l	S.S.	4,158
Vessel-buffer tank 1 required	500 l	S.S.	4,158
Vessel-fraction collector 1 required	500 l	S.S.	4,158
Vessel-final resuspension w/ agitator 1 required	500 l		6,929

Appendix E

MAJOR EQUIPMENT LIST
bGH FERMENTATION PLANT
(3.5 million cow daily capacity)

DESCRIPTION	DESIGN CONDITIONS	MATERIALS OF CONSTRUCTION	ESTIMATED TOTAL COST
(Continued)			
Displacement Pumps 14 required		S.S.	86,852
Total Equipment Cost			<u>\$16,439,662</u>

Appendix F

MAJOR EQUIPMENT LIST
 BGH FERMENTATION PLANT
 (4 million cow daily capacity)

DESCRIPTION	DESIGN CONDITIONS	MATERIALS OF CONSTRUCTION	ESTIMATED TOTAL COST
Seed inoculum vessel 1 required	3000 l w/agitator	304 S.S.	\$ 19,402
Fermentors 18 required	80,000 l w/ O ₂ , pH, foam, temp. controls and air incinerator	S.S.	18,497,527
Glass wool filter for air sterilization unit - 1 required	650 ft ³ /min.		152,250
Plate and frame filter 1 required	700 ft ²	304 S.S.	38,249
ATM suspended basket Centrifuges 3 required	20 Hp.	S.S.	166,302
Mixing vessels with agitator 2 required	1000 l used 950 l req. vol.	S.S.	19,402
IMpandex cell rupture device w/glass beads 2 required	500 gal/hr.		186,900
Chromatography columns 20 required	36" dia. 4 ft. high	glass lined	277,172
Storage tanks 3 required	600 l used 550 l req. vol.	S.S.	14,552
Tank w/ agitator 1 required	600 l used 550 l req. vol.		6,929
Displacement Pumps 12 required		S.S.	92,395
Total Equipment Cost			\$19,471,080

Appendix G

MAJOR EQUIPMENT LIST
bGH FERMENTATION PLANT
(4.5 million cow daily capacity)

DESCRIPTION	DESIGN CONDITIONS	MATERIALS OF CONSTRUCTION	ESTIMATED TOTAL COST
Seed inoculum vessel 1 required	4000 l w/agitator (3500 l vol. req.)	304 S.S.	\$ 20,788
Fermentors 18 required	90,000 l w/ O ₂ , pH, foam, temp. controls and air incinerator	S.S.	22,629,953
Glass wool filter for air sterilization unit - 1 required	700 ft ³ /min.		168,000
Plate and frame filter 1 required	750 ft ²	304 S.S.	39,843
ATM suspended basket Centrifuges 3 required	30 Hp.	S.S.	207,878
Mixing vessels with agitator 2 required	1000 l	S.S.	19,402
IMpandex cell rupture device w/glass beads 2 required	500 gal/hr.		186,900
Chromatography columns 20 required	36" dia. 4.5 ft. high	glass lined	311,816
Storage tanks 3 required	600 l	S.S.	14,552
Tank w/ agitator 1 required	600 l	S.S.	6,929
Displacement Pumps 12 required		S.S.	92,395
Total Equipment Cost			\$23,698,456

Appendix H

MAJOR EQUIPMENT LIST
bGH FERMENTATION PLANT
(5 million cow daily capacity)

DESCRIPTION	DESIGN CONDITIONS	MATERIALS OF CONSTRUCTION	ESTIMATED TOTAL COST
Seed inoculum vessel 1 required	4000 l w/agitator (3500 l vol. req.)	304 S.S.	\$ 20,788
Fermentors 18 required	100,000 l w/ O ₂ , pH, foam, temp. controls and air incinerator	S.S.	23,613,864
Glass wool filter for air sterilization unit - 1 required	750 ft ³ /min.		183,750
Plate and frame filter 2 required	400 ft ²	304 S.S.	41,437
ATM suspended basket Centrifuges 3 required	30 Hp.	S.S.	207,878
Mixing vessels with agitator 2 required	1200 l used 1100 l req. vol.	S.S.	20,788
Impandex cell rupture device w/glass beads 3 required	500 gal/hr.		280,350
Chromatography columns 24 required	36" dia. 5 ft. high	glass lined	415,756
Storage tanks 3 required	700 l	S.S.	15,580
Tank w/ agitator 1 required	900 l used 700 l req. vol.	S.S.	8,315
Displacement pumps 13 required		S.S.	122,718
Total Equipment Cost			\$24,931,224

Appendix I

MAJOR EQUIPMENT LIST
 bGH FERMENTATION PLANT
 (5.5 million cow daily capacity)

DESCRIPTION	DESIGN CONDITIONS	MATERIALS OF CONSTRUCTION	ESTIMATED TOTAL COST
Seed inoculum vessel 1 required	4000 l w/agitator	304 S.S.	\$ 20,788
Fermentors 24 required	82,500 l w/ O ₂ , pH, foam, temp. controls and air incinerator	S.S.	28,861,389
Glass wool filter for air sterilization unit - 1 required	800 ft ³ /min.		199,500
Plate and frame filter 2 required	425 ft ²	304 S.S.	43,031
ATM suspended basket Centrifuges 3 required	40 Hp.	S.S.	249,454
Mixing vessels with agitator 2 required	1200 l	S.S.	20,788
IMpandex cell rupture device w/glass beads 3 required	500 gal/hr.		280,350
Chromatography columns 24 required	36" dia. 5.5 ft. high	glass lined	457,332
Storage tanks 3 required	800 l	S.S.	16,630
Tank w/ agitator 1 required	900 l used 800 l req. vol.	S.S.	8,315
Displacement pumps 13 required		S.S.	122,718
Total Equipment Cost			\$30,280,295

Appendix J

MAJOR EQUIPMENT LIST
bGH FERMENTATION PLANT
(6 million cow daily capacity)

DESCRIPTION	DESIGN CONDITIONS	MATERIALS OF CONSTRUCTION	ESTIMATED TOTAL COST
Seed inoculum vessel 1 required	4000 l w/agitator	304 S.S.	\$ 20,788
Fermentors 24 required	90,000 l w/ O ₂ , pH, foam, temp. controls and air incinerator	S.S.	30,173,270
Glass wool filter for air sterilization unit - 1 required	850 ft ³ /min.		220,500
Plate and frame filter 2 required	450 ft ²	304 S.S.	44,237
ATM suspended basket Centrifuges 3 required	40 Hp.	S.S.	249,454
Mixing vessels with agitator 2 required	1300 l	S.S.	22,174
IMpandex cell rupture device w/glass beads 3 required	500 gal/hr.		280,350
Chromatography columns 28 required	36" dia. 6 ft. high	glass lined	582,058
Storage tanks 3 required	900 l	S.S.	17,877
Tank w/ agitator 1 required	900 l	S.S.	8,315
Displacement pumps 16 required		S.S.	139,347
Total Equipment Cost			\$31,758,370

Appendix K

MAJOR EQUIPMENT LIST
 bGH FERMENTATION PLANT
 (6.5 million cow daily capacity)

DESCRIPTION	DESIGN CONDITIONS	MATERIALS OF CONSTRUCTION	ESTIMATED TOTAL COST
Seed inoculum vessel 1 required	4500 l w/agitator	304 S.S.	\$ 22,867
Fermentors 24 required	100,000 l w/ O ₂ , pH, foam, temp. controls and air incinerator	S.S.	31,485,152
Glass wool filter for air sterilization unit - 1 required	900 ft ³ /min.		241,500
Plate and frame filter 3 required	320 ft ²	304 S.S.	47,818
ATM suspended basket Centrifuges 3 required	50 Hp.	S.S.	270,242
Mixing vessels with agitator 2 required	1400 l	S.S.	23,560
IMpandex cell rupture device w/glass beads 4 required	500 gal/hr.		373,800
Chromatography columns 28 required	36" dia. 6.5 ft. high	glass lined	630,563
Storage tanks 3 required	1000 l	S.S.	18,709
Tank w/ agitator 1 required	1000 l	S.S.	9,701
Displacement pumps 16 required		S.S.	139,347
Total Equipment Cost			<u>\$33,263,259</u>

Appendix L

MAJOR EQUIPMENT LIST
 BGH FERMENTATION PLANT
 (7 million cow daily capacity)

DESCRIPTION	DESIGN CONDITIONS	MATERIALS OF CONSTRUCTION	ESTIMATED TOTAL COST
Seed inoculum vessel 1 required	4500 l w/agitator	304 S.S.	22,868
Fermentors 30 required	84,000 l w/ O ₂ , pH, foam, temp. controls and air incinerator	S.S.	36,076,738
Glass wool filter for air sterilization unit - 1 required	950 ft ³ /min.		262,500
Plate and frame filter 4 required	250 ft ²	304 S.S.	51,001
ATM suspended basket Centrifuges 3 required	50 Hp.	S.S.	270,243
Mixing vessels with agitator 2 required	1500 l	S.S.	24,393
IMpandex cell rupture device w/glass beads 4 required	500 gal/hr.		373,800
Chromatography columns 32 required	36" dia. 7 ft. high	glass lined	776,077
Storage tanks 3 required	1100 l	S.S.	20,789
Mixing vessel w/ agitator 1 required	1100 l	S.S.	10,395
Displacement pumps 25 required		S.S.	220,108
Total Equipment Cost			38,108,912

Appendix M

OPERATING COSTS FOR THE 0.5 MILLION COW
BGH PRODUCTION FACILITY

Costs	Per/Unit	Total Cost
<u>Direct Costs</u>		
<u>Raw Materials</u>		
Medium (LB @ 240,000 l/da.)	\$.15/l	\$13,140,000
<u>Chemicals and Nutrients for Fermentation</u>		
Chemicals (NH ₄ , SO ₄ , NaHCO ₃ , Na ₂ CO ₃)		\$55,000
Agarose	\$10/ml	\$264,000
Antibiotic-Ampicillin (2400g/da.)	\$3.00/25g	\$105,120
<u>Sterilization</u>		
Continuous Steam Injection	\$2.97/1000#	\$127,471
Air	\$0.26/1000ft ³	\$166,492
<u>Direct Labor</u>		
108,160 hours straight time		
36,053 hours day shift	\$10.00/hr.	\$360,533
36,053 hours evening shift	10.15/hr.	\$365,941
36,053 hours night shift	10.20/hr.	\$367,744
5,408 hours overtime (1 1/2 straight time)		
1,803 hours day shift	\$15.00/hr.	\$27,040
1,803 hours evening shift	\$15.23/hr.	\$27,455
1,803 hours night shift	\$15.30/hr.	\$27,581
<u>Direct Supervisory Labor</u>		
8,281 hours	\$14.00/hr.	\$115,934
<u>Plant Energy (Electrical)</u>		
1000 KW/hr.	\$0.07/KWh	\$613,200
<u>Maintenance and Repair</u>		
(includes maintenance supervisory and maintenance labor; 1920 hrs. @ \$12.00/hr. and 1920 hrs. @ \$10.00/hr., respectively)	3% of total capital investment	\$485,232

Appendix M Continued

Costs	Per/Unit	Total Cost
Operating Supplies	15% maintenance	\$72,785
<u>Laboratory Charge</u>		
Chemist - 1920 hours	\$16.00/hr.	\$30,720
Direct Costs Total		<u>\$16,352,248</u>
<u>Overhead Costs</u>		
<u>Quality Control Manager</u>	--	\$35,000
<u>Plant Engineering</u>	--	\$30,000
<u>General overhead (personnel)</u>		
5760 hours of janitorial and general labor	\$6.00/hr.	\$34,560
1920 hours of shipping-receiving clerical	\$9.00/hr.	\$17,280
Employee - Personnel Benefits (covers medical, unemployment insurance, retirement, other benefits for all employees -- operating, overhead, administrative and marketing)	25% total wages and salaries	\$413,037
Payroll Overhead	5% payroll	\$82,607
Insurance	1% total fixed capital	\$161,744
Property Taxes	1% total fixed capital	\$161,744
Overhead Costs Total		<u>\$935,972</u>
<u>Administrative Costs</u>		
<u>General Manager</u>	--	\$45,000
<u>Comptroller</u>	--	\$28,000
<u>Clerks (2)</u>		
3840 hours	\$8.00/hr.	\$30,720

Appendix M Continued

Costs	Per/Unit	Total Cost
<u>Secretary (1)</u>		
1920 hours	\$6.00/hr.	\$11,520
Office Overhead	50% total administrative labor cost	\$57,620
		<u>\$172,860</u>
<u>Administrative Costs Total</u>		
<u>Marketing Costs</u>		
<u>Sales Manager</u>	--	\$28,000
<u>Clerk</u>		
1920 hours	\$8.00/hr.	\$15,360
<u>Secretary</u>		
1920 hours	\$6.00/hr.	\$11,520
<u>Marketing Overhead</u>	50% total marketing labor cost	\$27,440
		<u>\$82,320</u>
<u>Marketing Cost Total</u>		
		\$82,320
<u>Total Plant Operating Costs</u>		<u>\$17,543,400</u>

Appendix N

OPERATING COSTS FOR THE 1.0 MILLION COW
bGH PRODUCTION FACILITY

Costs	Per/Unit	Total Cost
<u>Direct Costs</u>		
<u>Raw Materials</u>		
Medium (LB @ 480,000 l/da.)	\$.15/l	\$26,280,000
<u>Chemicals and Nutrients for Fermentation</u>		
Chemicals (NH ₄ , SO ₄ , NaHCO ₃ , Na ₂ CO ₃)		\$65,000
Agarose	\$10/ml	\$264,000
Antibiotic-Ampicillin (4800g/da.)	\$3.00/25g	\$210,240
<u>Sterilization</u>		
Continuous Steam Injection	\$2.97/1000#	\$254,941
Air	\$0.26/1000ft ³	\$291,362
<u>Direct Labor</u>		
116,480 hours straight time		
38,827 hours day shift	\$10.00/hr.	\$388,267
38,827 hours evening shift	10.15/hr.	\$394,091
38,827 hours night shift	10.20/hr.	\$396,032
5,824 hours overtime (1 1/2 straight time)		
1,941 hours day shift	\$15.00/hr.	\$29,120
1,941 hours evening shift	\$15.23/hr.	\$29,567
1,941 hours night shift	\$15.30/hr.	\$29,702
<u>Direct Supervisory Labor</u>		
8,281 hours	\$14.00/hr.	\$115,934
<u>Plant Energy (Electrical)</u>		
1150 KW/hr.	\$0.07/KWh	\$705,180
<u>Maintenance and Repair</u>		
(includes maintenance supervisory and maintenance labor; 1920 hrs. @ \$12.00/hr. and 1920 hrs. @ \$10.00/hr., respectively)	3% of total capital investment	\$899,992

Appendix N Continued

Costs	Per/Unit	Total Cost
Operating Supplies	15% maintenance	\$134,999
<u>Laboratory Charge</u>		
Chemist - 1920 hours	\$16.00/hr.	\$30,720
Direct Costs Total		<u>\$30,519,147</u>
<u>Overhead Costs</u>		
<u>Quality Control Manager</u>	--	\$35,000
<u>Plant Engineering</u>	--	\$30,000
<u>General overhead (personnel)</u>		
5760 hours of janitorial and general labor	\$6.00/hr.	\$34,560
1920 hours of shipping-receiving clerical	\$9.00/hr.	\$17,280
Employee - Personnel Benefits (covers medical, unemployment insurance, retirement, other benefits for all employees -- operating, overhead, administrative and marketing)	25% total wages and salaries	\$439,498
Payroll Overhead	5% payroll	\$87,900
Insurance	1% total fixed capital	\$299,997
Property Taxes	1% total fixed capital	\$299,997
Overhead Costs Total		<u>\$1,244,232</u>
<u>Administrative Costs</u>		
<u>General Manager</u>	--	\$45,000
<u>Comptroller</u>	--	\$28,000
<u>Clerks (3)</u>		
5760 hours	\$8.00/hr.	\$46,080

Appendix N Continued

Costs	Per/Unit	Total Cost
<u>Secretary (1)</u>		
1920 hours	\$6.00/hr.	\$11,520
Office Overhead	50% total administrative labor cost	\$65,300
Administrative Costs Total		<u>\$195,900</u>
<u>Marketing Costs</u>		
<u>Sales Manager</u>	--	\$28,000
<u>Clerk</u>		
1920 hours	\$8.00/hr.	\$15,360
<u>Secretary</u>		
1920 hours	\$6.00/hr.	\$11,520
<u>Marketing Overhead</u>	50% total marketing labor cost	\$27,440
Marketing Cost Total		<u>\$82,320</u>
Total Plant Operating Costs		\$32,041,599

Appendix O

OPERATING COSTS FOR THE 2.5 MILLION COW
BGH PRODUCTION FACILITY

Costs	Per/Unit	Total Cost
<u>Direct Costs</u>		
<u>Raw Materials</u>		
Medium (LB @ 1,200,000 l/da.)	\$.13/l	\$56,940,000
<u>Chemicals and Nutrients for Fermentation</u>		
Chemicals (NH ₄ , SO ₄ , NaHCO ₃ , Na ₂ CO ₃)		\$75,000
Agarose	\$10/ml	\$264,000
Antibiotic-Ampicillin (12,000g/da.)	\$2.00/25g	\$350,400
<u>Sterilization</u>		
Continuous Steam Injection	\$2.97/1000#	\$637,354
Air	\$0.26/1000ft ³	\$832,462
<u>Direct Labor</u>		
133,120 hours straight time		
44,373 hours day shift	\$10.00/hr.	\$443,733
44,373 hours evening shift	10.15/hr.	\$450,389
44,373 hours night shift	10.20/hr.	\$452,608
6,656 hours overtime (1 1/2 straight time)		
2,219 hours day shift	\$15.00/hr.	\$33,280
2,219 hours evening shift	\$15.23/hr.	\$33,790
2,219 hours night shift	\$15.30/hr.	\$33,946
<u>Direct Supervisory Labor</u>		
8,281 hours	\$14.00/hr.	\$115,934
<u>Plant Energy (Electrical)</u>		
1375 KW/hr.	\$0.07/KWh	\$843,150
<u>Maintenance and Repair</u>		
(includes maintenance supervisory and maintenance labor; 3840 hrs. @ \$12.00/hr. and 9600 hrs. @ \$10.00/hr., respectively)	3% of total capital investment	\$1,901,441

Appendix O Continued

Costs	Per/Unit	Total Cost
Operating Supplies	15% maintenance	\$134,999
<u>Laboratory Charge</u>		
Chemist - 3840 hours	\$16.00/hr.	\$61,440
Direct Costs Total		<u>\$63,603,926</u>
<u>Overhead Costs</u>		
<u>Quality Control Manager</u>	--	\$38,000
<u>Plant Engineering</u>	--	\$33,000
<u>General overhead (personnel)</u>		
11520 hours of janitorial and general labor	\$6.00/hr.	\$69,120
3840 hours of shipping-receiving clerical	\$9.00/hr.	\$34,560
Employee - Personnel Benefits (covers medical, unemployment insurance, retirement, other benefits for all employees -- operating, overhead, administrative and marketing)	25% total wages and salaries	\$554,500
Payroll Overhead	5% payroll	\$110,900
Insurance	1% total fixed capital	\$633,814
Property Taxes	1% total fixed capital	\$633,814
Overhead Costs Total		<u>\$2,107,708</u>
<u>Administrative Costs</u>		
<u>General Manager</u>	--	\$50,000
<u>Comptroller</u>	--	\$28,000
<u>Clerks (5)</u>		
9600 hours	\$8.00/hr.	\$76,800

Appendix O Continued

Costs	Per/Unit	Total Cost
<u>Secretary (3)</u>		
5760 hours	\$6.00/hr.	\$34,560
Office Overhead	50% total administrative labor cost	\$94,680
Administrative Costs Total		<u>\$284,040</u>
<u>Marketing Costs</u>		
<u>Sales Manager</u>	--	\$33,000
<u>Clerk</u>		
3840 hours	\$8.00/hr.	\$30,720
<u>Secretary</u>		
3840 hours	\$6.00/hr.	\$23,040
<u>Marketing Overhead</u>	50% total marketing labor cost	\$43,380
Marketing Cost Total		<u>\$130,140</u>
Total Plant Operating Costs		<u>\$66,125,814</u>

Appendix P

OPERATING COSTS FOR THE 3.0 MILLION COW
 BGH PRODUCTION FACILITY

Costs	Per/Unit	Total Cost
<u>Direct Costs</u>		
<u>Raw Materials</u>		
Medium (LB @ 1,440,000 1/da.)	\$.12/1	\$63,072,000
<u>Chemicals and Nutrients for Fermentation</u>		
Chemicals (NH ₄ , SO ₄ , NaHCO ₃ , Na ₂ CO ₃)		\$85,000
Agarose	\$10/ml	\$288,000
Antibiotic-Ampicillin (14,400g/da.)	\$2.00/25g	\$420,480
<u>Sterilization</u>		
Continuous Steam Injection (500 psig)	\$2.97/1000#	\$765,865
Air	\$0.26/1000ft ³	\$915,708
<u>Direct Labor</u>		
133,120 hours straight time		
44,373 hours day shift	\$10.00/hr.	\$443,733
44,373 hours evening shift	10.15/hr.	\$450,389
44,373 hours night shift	10.20/hr.	\$452,608
6,656 hours overtime (1 1/2 straight time)		
2,219 hours day shift	\$15.00/hr.	\$33,280
2,219 hours evening shift	\$15.23/hr.	\$33,790
2,219 hours night shift	\$15.30/hr.	\$33,946
<u>Direct Supervisory Labor</u>		
8,281 hours	\$14.00/hr.	\$115,934
<u>Plant Energy (Electrical)</u>		
1500 KW/hr.	\$0.07/KWh	\$919,800
<u>Maintenance and Repair</u>		
(includes maintenance supervisory and maintenance labor; 5300 hrs. @ \$12.00/hr. and 12,520 hrs. @ \$10.00/hr., respectively)	3% of total capital investment	\$2,082,581

Appendix P Continued

Costs	Per/Unit	Total Cost
Operating Supplies	15% maintenance	\$312,387
<u>Laboratory Charge</u>		
Chemist - 3840 hours	\$16.00/hr.	\$61,440
Direct Costs Total		<u>\$70,034,333</u>
<u>Overhead Costs</u>		
<u>Quality Control Manager</u>	--	\$38,000
<u>Plant Engineering</u>	--	\$33,000
<u>General overhead (personnel)</u>		
14440 hours of janitorial and general labor	\$6.00/hr.	\$86,640
5300 hours of shipping-receiving clerical	\$9.00/hr.	\$47,700
Employee - Personnel Benefits (covers medical, unemployment insurance, retirement, other benefits for all employees -- operating, overhead, administrative and marketing)	25% total wages and salaries	\$574,345
Payroll Overhead	5% payroll	\$114,869
Insurance	1% total fixed capital	\$694,194
Property Taxes	1% total fixed capital	\$694,194
Overhead Costs Total		<u>\$2,282,942</u>
<u>Administrative Costs</u>		
<u>General Manager</u>	--	\$50,000
<u>Comptroller</u>	--	\$28,000
<u>Clerks (5)</u>		
9600 hours	\$8.00/hr.	\$76,800

Appendix P Continued

Costs	Per/Unit	Total Cost
<u>Secretary (3)</u>		
5760 hours	\$6.00/hr.	\$34,560
Office Overhead	50% total administrative labor cost	\$94,680
Administrative Costs Total		<u>\$284,040</u>
<u>Marketing Costs</u>		
<u>Sales Manager</u>	--	\$35,000
<u>Clerk</u>		
3840 hours	\$8.00/hr.	\$30,720
<u>Secretary</u>		
3840 hours	\$6.00/hr.	\$23,040
<u>Marketing Overhead</u>	50% total marketing labor cost	\$44,380
Marketing Cost Total		<u>\$133,140</u>
Total Plant Operating Costs		\$72,734,455

Appendix Q

OPERATING COSTS FOR THE 3.5 MILLION COW
bGH PRODUCTION FACILITY

Costs	Per/Unit	Total Cost
<u>Direct Costs</u>		
<u>Raw Materials</u>		
Medium (LB @ 1,680,000 l/da.)	\$.12/l	\$73,584,000
<u>Chemicals and Nutrients for Fermentation</u>		
Chemicals (NH ₄ , SO ₄ , NaHCO ₃ , Na ₂ CO ₃)		\$95,000
Agarose	\$10/ml	\$318,000
Antibiotic-Ampicillin (16,800g/da.)	\$2.00/25g	\$490,560
<u>Sterilization</u>		
Continuous Steam Injection (500 psig)	\$2.97/1000#	\$892,295
Air	\$0.26/1000ft ³	\$1,248,693
<u>Direct Labor</u>		
141,440 hours straight time		
47,147 hours day shift	\$10.00/hr.	\$471,467
47,147 hours evening shift	10.15/hr.	\$478,539
47,147 hours night shift	10.20/hr.	\$480,896
7,072 hours overtime (1 1/2 straight time)		
2,357 hours day shift	\$15.00/hr.	\$35,360
2,357 hours evening shift	\$15.23/hr.	\$35,902
2,357 hours night shift	\$15.30/hr.	\$36,067
<u>Direct Supervisory Labor</u>		
8,281 hours	\$14.00/hr.	\$115,934
<u>Plant Energy (Electrical)</u>		
1700 KW/hr.	\$0.07/KWh	\$1,042,440
<u>Maintenance and Repair</u>		
(includes maintenance supervisory and maintenance labor; 6760 hrs. @ \$12.00/hr. and 15,440 hrs. @ \$10.00/hr., respectively)	3% of total capital investment	\$2,174,967

Appendix Q Continued

Costs	Per/Unit	Total Cost
Operating Supplies	15% maintenance	\$326,245
<u>Laboratory Charge</u>		
Chemist - 3840 hours	\$16.00/hr.	\$61,440
Direct Costs Total		<u>\$81,887,805</u>
<u>Overhead Costs</u>		
<u>Quality Control Manager</u>	--	\$38,000
<u>Plant Engineering</u>	--	\$33,000
<u>General overhead (personnel)</u>		
17360 hours of janitorial and general labor	\$6.00/hr.	\$104,160
6760 hours of shipping-receiving clerical	\$9.00/hr.	\$60,840
Employee - Personnel Benefits (covers medical, unemployment insurance, retirement, other benefits for all employees -- operating, overhead, administrative and marketing)	25% total wages and salaries	\$631,751
Payroll Overhead	5% payroll	\$126,350
Insurance	1% total fixed capital	\$724,989
Property Taxes	1% total fixed capital	\$724,989
Overhead Costs Total		<u>\$2,440,079</u>
<u>Administrative Costs</u>		
<u>General Manager</u>	--	\$53,000
<u>Comptroller</u>	--	\$30,000
<u>Clerks (6)</u>		
11,520 hours	\$8.00/hr.	\$92,160

Appendix Q Continued

Costs	Per/Unit	Total Cost
<u>Secretary (4)</u>		
7680 hours	\$6.00/hr.	\$46,080
Office Overhead	50% total administrative labor cost	\$110,620
Administrative Costs Total		<u>\$331,860</u>
<u>Marketing Costs</u>		
<u>Sales Manager</u>	--	\$38,000
<u>Clerk (3)</u>		
5760 hours	\$8.00/hr.	\$46,080
<u>Secretary (3)</u>		
5760 hours	\$6.00/hr.	\$34,560
<u>Marketing Overhead</u>	50% total marketing labor cost	\$59,320
Marketing Cost Total		<u>\$177,960</u>
Total Plant Operating Costs		<u>\$84,841,704</u>

Appendix R

OPERATING COSTS FOR THE 4.0 MILLION COW
bGH PRODUCTION FACILITY

Costs	Per/Unit	Total Cost
<u>Direct Costs</u>		
<u>Raw Materials</u>		
Medium (LB @ 1,920,000 1/da.)	\$.11/1	\$77,088,000
<u>Chemicals and Nutrients for Fermentation</u>		
Chemicals (NH ₄ , SO ₄ , NaHCO ₃ , Na ₂ CO ₃)		\$105,000
Agarose	\$10/ml	\$348,000
Antibiotic-Ampicillin (19,200g/da.)	\$2.00/25g	\$560,640
<u>Sterilization</u>		
Continuous Steam Injection (500 psig)	\$2.97/1000#	\$1,019,766
Air	\$0.26/1000ft ³	\$1,623,300
<u>Direct Labor</u>		
158,080 hours straight time		
52,693 hours day shift	\$10.00/hr.	\$526,933
52,693 hours evening shift	10.15/hr.	\$534,837
52,693 hours night shift	10.20/hr.	\$537,472
7,904 hours overtime (1 1/2 straight time)		
2,635 hours day shift	\$15.00/hr.	\$39,520
2,635 hours evening shift	\$15.23/hr.	\$40,126
2,635 hours night shift	\$15.30/hr.	\$40,310
<u>Direct Supervisory Labor</u>		
8,281 hours	\$14.00/hr.	\$115,934
<u>Plant Energy (Electrical)</u>		
1900 KW/hr.	\$0.07/KWh	\$1,165,080
<u>Maintenance and Repair</u>		
(includes maintenance supervisory and maintenance labor; 8220 hrs. @ \$12.00/hr. and 18,360 hrs. @ \$10.00/hr., respectively)	3% of total capital investment	\$2,576,024

Appendix R Continued

Costs	Per/Unit	Total Cost
Operating Supplies	15% maintenance	\$386,404
<u>Laboratory Charge</u>		
Chemist - 5760 hours	\$16.00/hr.	\$92,160
Direct Costs Total		<u>\$86,799,506</u>
<u>Overhead Costs</u>		
<u>Quality Control Manager</u>	--	\$40,000
<u>Plant Engineering</u>	--	\$35,000
<u>General overhead (personnel)</u>		
20280 hours of janitorial and general labor	\$6.00/hr.	\$121,680
8220 hours of shipping-receiving clerical	\$9.00/hr.	\$73,980
Employee - Personnel Benefits (covers medical, unemployment insurance, retirement, other benefits for all employees -- operating, overhead, administrative and marketing)	25% total wages and salaries	\$710,358
Payroll Overhead	5% payroll	\$142,072
Insurance	1% total fixed capital	\$858,675
Property Taxes	1% total fixed capital	\$858,675
Overhead Costs Total		<u>\$2,840,440</u>
<u>Administrative Costs</u>		
<u>General Manager</u>	--	\$55,000
<u>Comptroller</u>	--	\$32,000
<u>Clerks (6)</u>		
11,520 hours	\$8.00/hr.	\$92,160

Appendix R Continued

Costs	Per/Unit	Total Cost
<u>Secretary (4)</u>		
7680 hours	\$6.00/hr.	\$46,080
Office Overhead	50% total administrative labor cost	\$112,620
Administrative Costs Total		<u>\$337,860</u>
<u>Marketing Costs</u>		
<u>Sales Manager</u>		
	--	\$40,000
<u>Clerk (4)</u>		
7680 hours	\$8.00/hr.	\$61,440
<u>Secretary (3)</u>		
5760 hours	\$6.00/hr.	\$34,560
<u>Marketing Overhead</u>	50% total marketing labor cost	\$68,000
Marketing Cost Total		<u>\$204,000</u>
Total Plant Operating Costs		\$90,181,806

Appendix S

OPERATING COSTS FOR THE 4.5 MILLION COW
bGH PRODUCTION FACILITY

Costs	Per/Unit	Total Cost
<u>Direct Costs</u>		
<u>Raw Materials</u>		
Medium (LB @ 2,160,000 1/da.)	\$.10/1	\$78,840,000
<u>Chemicals and Nutrients for Fermentation</u>		
Chemicals (NH ₄ , SO ₄ , NaHCO ₃ , Na ₂ CO ₃)		\$120,000
Agarose	\$10/ml	\$378,000
Antibiotic-Ampicillin (21,600g/da.)	\$2.00/25g	\$630,720
<u>Sterilization</u>		
Continuous Steam Injection (500 psig)	\$2.97/1000#	\$1,147,236
Air	\$0.26/1000ft ³	\$1,748,170
<u>Direct Labor</u>		
158,080 hours straight time		
52,693 hours day shift	\$10.00/hr.	\$526,933
52,693 hours evening shift	10.15/hr.	\$534,837
52,693 hours night shift	10.20/hr.	\$537,472
7,904 hours overtime (1 1/2 straight time)		
2,635 hours day shift	\$15.00/hr.	\$39,520
2,635 hours evening shift	\$15.23/hr.	\$40,126
2,635 hours night shift	\$15.30/hr.	\$40,310
<u>Direct Supervisory Labor</u>		
8,281 hours	\$14.00/hr.	\$115,934
<u>Plant Energy (Electrical)</u>		
2100 KW/hr.	\$0.07/KWh	\$1,287,720
<u>Maintenance and Repair</u>		
(includes maintenance supervisory and maintenance labor; 9680 hrs. @ \$12.00/hr. and 21,280 hrs. @ \$10.00/hr., respectively)	3% of total capital investment	\$3,135,306

Appendix S Continued

Costs	Per/Unit	Total Cost
Operating Supplies	15% maintenance	\$470,296
<u>Laboratory Charge</u>		
Chemist - 5760 hours	\$16.00/hr.	\$92,160
Direct Costs Total		<u>\$89,684,740</u>
<u>Overhead Costs</u>		
<u>Quality Control Manager</u>	--	\$40,000
<u>Plant Engineering</u>	--	\$35,000
<u>General overhead (personnel)</u>		
23200 hours of janitorial and general labor	\$6.00/hr.	\$139,200
9680 hours of shipping-receiving clerical	\$9.00/hr.	\$87,120
Employee - Personnel Benefits (covers medical, unemployment insurance, retirement, other benefits for all employees -- operating, overhead, administrative and marketing)	25% total wages and salaries	\$729,703
Payroll Overhead	5% payroll	\$145,941
Insurance	1% total fixed capital	\$1,045,102
Property Taxes	1% total fixed capital	\$1,045,102
Overhead Costs Total		<u>\$3,267,168</u>
<u>Administrative Costs</u>		
<u>General Manager</u>	--	\$55,000
<u>Comptroller</u>	--	\$32,000
<u>Clerks (6)</u>		
11,520 hours	\$8.00/hr.	\$92,160

Appendix S Continued

Costs	Per/Unit	Total Cost
<u>Secretary (4)</u>		
7680 hours	\$6.00/hr.	\$46,080
Office Overhead	50% total administrative labor cost	\$112,620
Administrative Costs Total		<u>\$337,860</u>
<u>Marketing Costs</u>		
<u>Sales Manager</u>	--	\$40,000
<u>Clerk (4)</u>		
7680 hours	\$8.00/hr.	\$61,440
<u>Secretary (3)</u>		
5760 hours	\$6.00/hr.	\$34,560
<u>Marketing Overhead</u>	50% total marketing labor cost	\$68,000
Marketing Cost Total		<u>\$204,000</u>
Total Plant Operating Costs		<u>\$93,493,768</u>

Appendix T

OPERATING COSTS FOR THE 5.0 MILLION COW
BGH PRODUCTION FACILITY

Costs	Per/Unit	Total Cost
<u>Direct Costs</u>		
<u>Raw Materials</u>		
Medium (LB @ 2,400,000 l/da.)	\$.09/l	\$78,840,000
<u>Chemicals and Nutrients for Fermentation</u>		
Chemicals (NH ₄ , SO ₄ , NaHCO ₃ , Na ₂ CO ₃)		\$135,000
Agarose	\$10/ml	\$408,000
Antibiotic-Ampicillin (24,000g/da.)	\$2.00/25g	\$700,800
<u>Sterilization</u>		
Continuous Steam Injection (500 psig)	\$2.97/1000#	\$1,274,707
Air	\$0.26/1000ft ³	\$1,873,039
<u>Direct Labor</u>		
158,080 hours straight time		
52,693 hours day shift	\$10.00/hr.	\$526,933
52,693 hours evening shift	10.15/hr.	\$534,837
52,693 hours night shift	10.20/hr.	\$537,472
7,904 hours overtime (1 1/2 straight time)		
2,635 hours day shift	\$15.00/hr.	\$39,520
2,635 hours evening shift	\$15.23/hr.	\$40,126
2,635 hours night shift	\$15.30/hr.	\$40,310
<u>Direct Supervisory Labor</u>		
8,281 hours	\$14.00/hr.	\$115,934
<u>Plant Energy (Electrical)</u>		
2400 KW/hr.	\$0.07/KWh	\$1,471,680
<u>Maintenance and Repair</u>		
(includes maintenance supervisory and maintenance labor; 11,140 hrs. @ \$12.00/hr. and 24,200 hrs. @ \$10.00/hr., respectively)	3% of total capital investment	\$3,298,401

Appendix T Continued

Costs	Per/Unit	Total Cost
Operating Supplies	15% maintenance	\$494,760
<u>Laboratory Charge</u>		
Chemist - 5760 hours	\$16.00/hr.	\$92,160
Direct Costs Total		<u>\$90,423,679</u>
<u>Overhead Costs</u>		
<u>Quality Control Manager</u>	--	\$45,000
<u>Plant Engineering</u>	--	\$38,000
<u>General overhead (personnel)</u>		
26120 hours of janitorial and general labor	\$6.00/hr.	\$156,720
11140 hours of shipping-receiving clerical	\$9.00/hr.	\$100,260
Employee - Personnel Benefits (covers medical, unemployment insurance, retirement, other benefits for all employees -- operating, overhead, administrative and marketing)	25% total wages and salaries	\$759,768
Payroll Overhead	5% payroll	\$151,954
Insurance	1% total fixed capital	\$1,099,467
Property Taxes	1% total fixed capital	\$1,099,467
Overhead Costs Total		<u>\$3,450,636</u>
<u>Administrative Costs</u>		
<u>General Manager</u>	--	\$55,000
<u>Comptroller</u>	--	\$35,000
<u>Clerks (6)</u>		
11,520 hours	\$8.00/hr.	\$92,160

Appendix T Continued

Costs	Per/Unit	Total Cost
<u>Secretary (4)</u>		
7680 hours	\$6.00/hr.	\$46,080
Office Overhead	50% total administrative labor cost	\$112,620
Administrative Costs Total		<u>\$337,860</u>
<u>Marketing Costs</u>		
<u>Sales Manager</u>	--	\$45,000
<u>Clerk (5)</u>		
9600 hours	\$8.00/hr.	\$76,800
<u>Secretary (4)</u>		
7680 hours	\$6.00/hr.	\$46,080
<u>Marketing Overhead</u>	50% total marketing labor cost	\$83,940
Marketing Cost Total		<u>\$251,820</u>
Total Plant Operating Costs		\$94,463,995

Appendix U

OPERATING COSTS FOR THE 5.5 MILLION COW
BGH PRODUCTION FACILITY

Costs	Per/Unit	Total Cost
<u>Direct Costs</u>		
<u>Raw Materials</u>		
Medium (LB @ 2,640,000 1/da.)	\$.08/1	\$77,088,000
<u>Chemicals and Nutrients for Fermentation</u>		
Chemicals (NH ₄ , SO ₄ , NaHCO ₃ , Na ₂ CO ₃)		\$150,000
Agarose	\$10/ml	\$438,000
Antibiotic-Ampicillin (26,400g/da.)	\$2.00/25g	\$770,880
<u>Sterilization</u>		
Continuous Steam Injection (500 psig)	\$2.97/1000#	\$1,402,178
Air	\$0.26/1000ft ³	\$2,663,878
<u>Direct Labor</u>		
174,720 hours straight time		
58,240 hours day shift	\$10.00/hr.	\$582,400
58,240 hours evening shift	10.15/hr.	\$591,360
58,240 hours night shift	10.20/hr.	\$594,048
8,736 hours overtime (1 1/2 straight time)		
2,912 hours day shift	\$15.00/hr.	\$43,680
2,912 hours evening shift	\$15.23/hr.	\$44,350
2,912 hours night shift	\$15.30/hr.	\$44,554
<u>Direct Supervisory Labor</u>		
8,281 hours	\$14.00/hr.	\$115,934
<u>Plant Energy (Electrical)</u>		
2700 KW/hr.	\$0.07/KWh	\$1,655,640
<u>Maintenance and Repair</u>		
(includes maintenance supervisory and maintenance labor; 12,600 hrs. @ \$12.00/hr. and 27,120 hrs. @ \$10.00/hr., respectively)	3% of total capital investment	\$4,006,083

Appendix U Continued

Costs	Per/Unit	Total Cost
Operating Supplies	15% maintenance	\$600,912
<u>Laboratory Charge</u>		
Chemist - 5760 hours	\$16.00/hr.	\$92,160
Direct Costs Total		<u>\$90,884,057</u>
<u>Overhead Costs</u>		
<u>Quality Control Manager</u>	--	\$45,000
<u>Plant Engineering</u>	--	\$40,000
<u>General overhead (personnel)</u>		
29040 hours of janitorial and general labor	\$6.00/hr.	\$174,240
12600 hours of shipping-receiving clerical	\$9.00/hr.	\$113,400
Employee - Personnel Benefits (covers medical, unemployment insurance, retirement, other benefits for all employees -- operating, overhead, administrative and marketing)	25% total wages and salaries	\$841,952
Payroll Overhead	5% payroll	\$168,390
Insurance	1% total fixed capital	\$1,335,361
Property Taxes	1% total fixed capital	\$1,335,361
Overhead Costs Total		<u>\$4,053,704</u>
<u>Administrative Costs</u>		
<u>General Manager</u>	--	\$60,000
<u>Comptroller</u>	--	\$40,000
<u>Clerks (7)</u>		
13,440 hours	\$8.00/hr.	\$107,520

Appendix U Continued

Costs	Per/Unit	Total Cost
<u>Secretary (5)</u>		
9600 hours	\$6.00/hr.	\$57,600
Office Overhead	50% total administrative labor cost	\$132,560
Administrative Costs Total		<u>\$397,680</u>
<u>Marketing Costs</u>		
<u>Sales Manager</u>	--	\$50,000
<u>Clerk (6)</u>		
11,520 hours	\$8.00/hr.	\$92,160
<u>Secretary (5)</u>		
9600 hours	\$6.00/hr.	\$57,600
<u>Marketing Overhead</u>	50% total marketing labor cost	\$99,880
Marketing Cost Total		<u>\$299,640</u>
Total Plant Operating Costs		<u>\$95,635,081</u>

Appendix V

OPERATING COSTS FOR THE 6.0 MILLION COW
BGH PRODUCTION FACILITY

Costs	Per/Unit	Total Cost
<u>Direct Costs</u>		
<u>Raw Materials</u>		
Medium (LB @ 2,880,000 1/da.)	\$.08/1	\$84,096,000
<u>Chemicals and Nutrients for Fermentation</u>		
Chemicals (NH ₄ , SO ₄ , NaHCO ₃ , Na ₂ CO ₃)		\$165,000
Agarose	\$10/ml	\$468,000
Antibiotic-Ampicillin (28,800g/da.)	\$2.00/25g	\$840,960
<u>Sterilization</u>		
Continuous Steam Injection (500 psig)	\$2.97/1000#	\$1,529,648
Air	\$0.26/1000ft ³	\$2,830,370
<u>Direct Labor</u>		
183,040 hours straight time		
61,013 hours day shift	\$10.00/hr.	\$610,133
61,013 hours evening shift	10.15/hr.	\$619,285
61,013 hours night shift	10.20/hr.	\$622,336
9,152 hours overtime (1 1/2 straight time)		
3,051 hours day shift	\$15.00/hr.	\$45,760
3,051 hours evening shift	\$15.23/hr.	\$46,462
3,051 hours night shift	\$15.30/hr.	\$46,675
<u>Direct Supervisory Labor</u>		
8,281 hours	\$14.00/hr.	\$115,934
<u>Plant Energy (Electrical)</u>		
3000 KW/hr.	\$0.07/KWh	\$1,839,600
<u>Maintenance and Repair</u>		
(includes maintenance supervisory and maintenance labor; 14,060 hrs. @ \$12.00/hr. and 30,040 hrs. @ \$10.00/hr., respectively)	3% of total capital investment	\$4,201,632

Appendix V Continued

Costs	Per/Unit	Total Cost
Operating Supplies	15% maintenance	\$630,245
<u>Laboratory Charge</u>		
Chemist - 5760 hours	\$16.00/hr.	\$92,160
Direct Costs Total		<u>\$98,800,200</u>

Overhead Costs

<u>Quality Control Manager</u>	--	\$45,000
<u>Plant Engineering</u>	--	\$40,000
<u>General overhead (personnel)</u>		
31960 hours of janitorial and general labor	\$6.00/hr.	\$191,760
14060 hours of shipping-receiving clerical	\$9.00/hr.	\$126,540
Employee - Personnel Benefits (covers medical, unemployment insurance, retirement, other benefits for all employees -- operating, overhead, administrative and marketing)	25% total wages and salaries	\$884,011
Payroll Overhead	5% payroll	\$176,802
Insurance	1% total fixed capital	\$1,400,544
Property Taxes	1% total fixed capital	\$1,400,544
Overhead Costs Total		<u>\$4,265,201</u>

Administrative Costs

<u>General Manager</u>	--	\$60,000
<u>Comptroller</u>	--	\$40,000
<u>Clerks (7)</u>		
13,440 hours	\$8.00/hr.	\$107,520

Appendix V Continued

Costs	Per/Unit	Total Cost
<u>Secretary (5)</u>		
9600 hours	\$6.00/hr.	\$57,600
Office Overhead	50% total administrative labor cost	\$132,560
Administrative Costs Total		<u>\$397,680</u>
<u>Marketing Costs</u>		
<u>Sales Manager</u>	--	\$50,000
<u>Clerk (6)</u>		
11,520 hours	\$8.00/hr.	\$92,160
<u>Secretary (5)</u>		
9600 hours	\$6.00/hr.	\$57,600
<u>Marketing Overhead</u>	50% total marketing labor cost	\$99,880
Marketing Cost Total		<u>\$299,640</u>
Total Plant Operating Costs		\$103,762,721

Appendix W

OPERATING COSTS FOR THE 6.5 MILLION COW
BGH PRODUCTION FACILITY

Costs	Per/Unit	Total Cost
<u>Direct Costs</u>		
<u>Raw Materials</u>		
Medium (LB @ 3,120,000 l/da.)	\$.07/l	\$79,716,000
<u>Chemicals and Nutrients for Fermentation</u>		
Chemicals (NH ₄ , SO ₄ , NaHCO ₃ , Na ₂ CO ₃)		\$180,000
Agarose	\$10/ml	\$498,000
Antibiotic-Ampicillin (32,000g/da.)	\$2.00/25g	\$934,400
<u>Sterilization</u>		
Continuous Steam Injection (500 psig)	\$2.97/1000#	\$1,699,609
Air	\$0.26/1000ft ³	\$2,996,862
<u>Direct Labor</u>		
183,040 hours straight time		
61,013 hours day shift	\$10.00/hr.	\$610,133
61,013 hours evening shift	10.15/hr.	\$619,285
61,013 hours night shift	10.20/hr.	\$622,336
9,152 hours overtime (1 1/2 straight time)		
3,051 hours day shift	\$15.00/hr.	\$45,760
3,051 hours evening shift	\$15.23/hr.	\$46,462
3,051 hours night shift	\$15.30/hr.	\$46,675
<u>Direct Supervisory Labor</u>		
8,281 hours	\$14.00/hr.	\$115,934
<u>Plant Energy (Electrical)</u>		
3300 KW/hr.	\$0.07/KWh	\$2,023,560
<u>Maintenance and Repair</u>		
(includes maintenance supervisory and maintenance labor; 15,520 hrs. @ \$12.00/hr. and 32,960 hrs. @ \$10.00/hr., respectively)	3% of total capital investment	\$4,400,729

Appendix W Continued

Costs	Per/Unit	Total Cost
Operating Supplies	15% maintenance	\$660,109
<u>Laboratory Charge</u>		
Chemist - 5760 hours	\$16.00/hr.	\$92,160
Direct Costs Total		<u>\$95,308,014</u>

Overhead Costs

<u>Quality Control Manager</u>	--	\$50,000
<u>Plant Engineering</u>	--	\$45,000
<u>General overhead (personnel)</u>		
34880 hours of janitorial and general labor	\$6.00/hr.	\$209,280
15520 hours of shipping-receiving clerical	\$9.00/hr.	\$139,680
Employee - Personnel Benefits (covers medical, unemployment insurance, retirement, other benefits for all employees -- operating, overhead, administrative and marketing)	25% total wages and salaries	\$921,416
Payroll Overhead	5% payroll	\$184,283
Insurance	1% total fixed capital	\$1,466,910
Property Taxes	1% total fixed capital	\$1,466,910
Overhead Costs Total		<u>\$4,483,479</u>

Administrative Costs

<u>General Manager</u>	--	\$65,000
<u>Comptroller</u>	--	\$45,000
<u>Clerks (8)</u>		
15,360 hours	\$8.00/hr.	\$122,880

Appendix W Continued

Costs	Per/Unit	Total Cost
<u>Secretary (6)</u>		
11,520 hours	\$6.00/hr.	\$69,120
Office Overhead	50% total administrative labor cost	\$151,000
Administrative Costs Total		<u>\$453,000</u>
<u>Marketing Costs</u>		
<u>Sales Manager</u>	--	\$60,000
<u>Clerk (7)</u>		
13,440 hours	\$8.00/hr.	\$107,520
<u>Secretary (5)</u>		
9600 hours	\$6.00/hr.	\$57,600
<u>Marketing Overhead</u>	50% total marketing labor cost	\$112,560
Marketing Cost Total		<u>\$337,680</u>
Total Plant Operating Costs		<u>\$100,582,173</u>

Appendix X

OPERATING COSTS FOR THE 7.0 MILLION COW
BGH PRODUCTION FACILITY

Costs	Per/Unit	Total Cost
<u>Direct Costs</u>		
<u>Raw Materials</u>		
Medium (LB @ 3,360,000 l/da.)	\$.07/l	\$85,848,000
<u>Chemicals and Nutrients for Fermentation</u>		
Chemicals (NH ₄ , SO ₄ , NaHCO ₃ , Na ₂ CO ₃)		\$195,000
Agarose	\$10/ml	\$528,000
Antibiotic-Ampicillin (33,600g/da.)	\$2.00/25g	\$981,120
<u>Sterilization</u>		
Continuous Steam Injection (500 psig)	\$2.97/1000#	\$1,784,590
Air	\$0.26/1000ft ³	\$3,954,193
<u>Direct Labor</u>		
199,680 hours straight time		
66,560 hours day shift	\$10.00/hr.	\$665,600
66,560 hours evening shift	10.15/hr.	\$675,584
66,560 hours night shift	10.20/hr.	\$678,912
9,984 hours overtime (1 1/2 straight time)		
3,328 hours day shift	\$15.00/hr.	\$49,920
3,328 hours evening shift	\$15.23/hr.	\$50,685
3,328 hours night shift	\$15.30/hr.	\$50,918
<u>Direct Supervisory Labor</u>		
8,281 hours	\$14.00/hr.	\$115,934
<u>Plant Energy (Electrical)</u>		
3600 KW/hr.	\$0.07/KWh	\$2,207,520
<u>Maintenance and Repair</u>		
(includes maintenance supervisory and maintenance labor; 16,980 hrs. @ \$12.00/hr. and 35,880 hrs. @ \$10.00/hr., respectively)	3% of total capital investment	\$5,041,809

Appendix X Continued

Costs	Per/Unit	Total Cost
Operating Supplies	15% maintenance	\$756,271
<u>Laboratory Charge</u>		
Chemist - 5760 hours	\$16.00/hr.	\$92,160
Direct Costs Total		<u>\$103,676,216</u>
<u>Overhead Costs</u>		
<u>Quality Control Manager</u>	--	\$50,000
<u>Plant Engineering</u>	--	\$45,000
<u>General overhead (personnel)</u>		
37800 hours of janitorial and general labor	\$6.00/hr.	\$226,800
16980 hours of shipping-receiving clerical	\$9.00/hr.	\$152,820
Employee - Personnel Benefits (covers medical, unemployment insurance, retirement, other benefits for all employees -- operating, overhead, administrative and marketing)	25% total wages and salaries	\$986,003
Payroll Overhead	5% payroll	\$197,201
Insurance	1% total fixed capital	\$1,680,603
Property Taxes	1% total fixed capital	\$1,608,603
Overhead Costs Total		<u>\$4,947,030</u>
<u>Administrative Costs</u>		
<u>General Manager</u>	--	\$65,000
<u>Comptroller</u>	--	\$45,000
<u>Clerks (8)</u>		
15,360 hours	\$8.00/hr.	\$122,880

Appendix X Continued

Costs	Per/Unit	Total Cost
<u>Secretary (6)</u>		
11,520 hours	\$6.00/hr.	\$69,120
Office Overhead	50% total administrative labor cost	\$151,000
Administrative Costs Total		<u>\$453,000</u>
<u>Marketing Costs</u>		
<u>Sales Manager</u>		
	--	\$60,000
<u>Clerk (7)</u>		
13,440 hours	\$8.00/hr.	\$107,520
<u>Secretary (5)</u>		
9600 hours	\$6.00/hr.	\$57,600
<u>Marketing Overhead</u>	50% total marketing labor cost	\$112,560
Marketing Cost Total		<u>\$337,680</u>
Total Plant Operating Costs		\$109,413,926

Appendix Y

Table Y-1

DCF CASH FLOW RESULTS^a
(0.5 Million Cow Plant)

Year	Gross Revenue	Depreciation	State Sev./ Income Tax	Taxable Income	Federal Tax	After Tax Value
1	0.	0.	0.	0.	0.	0.
2	0.	0.	0.	0.	0.	0.
3	0.	0.	0.	0.	0.	0.
4	20938500.	1632747.	70819.	1770481.	238140.	1311068.
5	20938500.	2798995.	24029.	600725.	265280.	3025140.
6	20938500.	2369519.	41068.	1026695.	453389.	2816470.
7	20938500.	1974600.	56724.	1418105.	626235.	2624440.
8	20938500.	1611918.	71091.	1777276.	784845.	2447936.
9	20938500.	1279300.	84255.	2106384.	930179.	2285911.
10	20938500.	974705.	96299.	2407467.	1063138.	2137380.
11	20938500.	696218.	107298.	2682442.	1184567.	2001423.
12	20938500.	442043.	117324.	2933105.	1295259.	1877174.
13	20938500.	210497.	126446.	3161139.	1395959.	1763824.
14	20938500.	0.	134725.	3368120.	1487362.	1660609.
15	20938500.	0.	134584.	3364606.	1485810.	1658770.
16	20938500.	0.	134444.	3361090.	1484257.	1656930.
17	20938500.	0.	134303.	3357574.	1482705.	1655090.
18	20938500.	0.	134162.	3354058.	1481152.	1653251.
19	20938500.	0.	134022.	3350540.	1479599.	1651410.
20	20938500.	0.	133881.	3347022.	1478045.	1649569.
21	20938500.	0.	133740.	3343504.	1476491.	1647728.
22	20938500.	0.	133599.	3339984.	1474937.	1645886.
23	20938500.	0.	133458.	3336462.	1473382.	3375643.

^aThe after tax net present value from the Monte Carlo analysis equals \$10,480,000, with a standard deviation of \$5,410,000. This is based upon the present value of the after tax flows shown less the present value of investment expended over the first three years of the time horizon (\$17,260,000 including the contingency factor). The analysis pertains only to the specific investment in question and, consequently, no tax liabilities or credits are applicable to the three year construction period. The cash flow values shown are a result of using mean values and not the average of the Monte Carlo runs. The difference in after tax net present value between the two types of runs is less than 1 percent.

Table Y-2

DCF CASH FLOW RESULTS^a
(1.0 Million Cow Plant)

Year	Gross Revenue	Depreciation	State Sev./ Income Tax	Taxable Income	Federal Tax	After Tax Value
1	0.	0.	0.	0.	0.	0.
2	0.	0.	0.	0.	0.	0.
3	0.	0.	0.	0.	0.	0.
4	38016000.	3025824.	115668.	2891712.	269380.	2268322.
5	38016000.	5187128.	28960.	723989.	319713.	5406354.
6	38016000.	4391219.	60539.	1513477.	668351.	5019686.
7	38016000.	3659349.	89557.	2238923.	988708.	4663856.
8	38016000.	2987224.	116185.	2904624.	1282682.	4336798.
9	38016000.	2370813.	140584.	3514607.	1552051.	4036571.
10	38016000.	1806334.	162906.	4072658.	1798486.	3761355.
11	38016000.	1290239.	183293.	4582326.	2023555.	3509439.
12	38016000.	819199.	201877.	5046937.	2228728.	3279223.
13	38016000.	390095.	218784.	5469609.	2415380.	3069201.
14	38016000.	0.	234131.	5853270.	2584804.	2877965.
15	38016000.	0.	233874.	5846838.	2581964.	2874599.
16	38016000.	0.	233616.	5840402.	2579122.	2871232.
17	38016000.	0.	233359.	5833968.	2576280.	2867864.
18	38016000.	0.	233101.	5827528.	2573437.	2864495.
19	38016000.	0.	232844.	5821088.	2570593.	2861125.
20	38016000.	0.	232586.	5814650.	2567750.	2857757.
21	38016000.	0.	232328.	5808210.	2564906.	2854386.
22	38016000.	0.	232071.	5801768.	2562061.	2851016.
23	38016000.	0.	231813.	5795321.	2559214.	6017348.

^aThe after tax net present value from the Monte Carlo analysis equals \$16,860,000, with a standard deviation of \$9,790,000. This is based upon the present value of the after tax flows shown less the present value of investment expended over the first three years of the time horizon (\$31,990,000 including the contingency factor). The analysis pertains only to the specific investment in question and, consequently, no tax liabilities or credits are applicable to the three year construction period. The cash flow values shown are a result of using mean values and not the average of the Monte Carlo runs. The difference in after tax net present value between the two types of runs is less than 1 percent.

Table Y-3

DCF CASH FLOW RESULTS^a
 (2.5 Million Cow Plant)

Year	Gross Revenue	Depreciation	State Sev./ Income Tax	Taxable Income	Federal Tax	After Tax Value
1	0.	0.	0.	0.	0.	0.
2	0.	0.	0.	0.	0.	0.
3	0.	0.	0.	0.	0.	0.
4	78457500.	6391180.	237502.	5937540.	493755.	4872679.
5	78457500.	10956310.	54367.	1359187.	600217.	11339340.
6	78457500.	9275182.	121083.	3027086.	1336761.	10522790.
7	78457500.	7729320.	182389.	4559713.	2013569.	9771372.
8	78457500.	6309649.	238646.	5966152.	2634653.	9080736.
9	78457500.	5007658.	290196.	7254898.	3203763.	8446766.
10	78457500.	3815359.	337358.	8433958.	3724436.	7865628.
11	78457500.	2725256.	380433.	9510816.	4199977.	7333704.
12	78457500.	1730321.	419700.	10492510.	4633491.	6847615.
13	78457500.	823963.	455425.	11385620.	5027889.	6404178.
14	78457500.	0.	487853.	12196320.	5385895.	6000420.
15	78457500.	0.	487323.	12183070.	5380045.	5993489.
16	78457500.	0.	486792.	12169810.	5374189.	5986549.
17	78457500.	0.	486262.	12156560.	5368335.	5979614.
18	78457500.	0.	485732.	12143290.	5362476.	5972671.
19	78457500.	0.	485201.	12130020.	5356619.	5965731.
20	78457500.	0.	484670.	12116760.	5350760.	5958787.
21	78457500.	0.	484140.	12103490.	5344902.	5951848.
22	78457500.	0.	483609.	12090220.	5339040.	5944900.
23	78457500.	0.	483077.	12076940.	5333175.	12468130.

^aThe after tax net present value from the Monte Carlo analysis equals \$34,600,000, with a standard deviation of \$20,150,000. This is based upon the present value of the after tax flows shown less the present value of investment expended over the first three years of the time horizon (\$67,560,000 including the contingency factor). The analysis pertains only to the specific investment in question and, consequently, no tax liabilities or credits are applicable to the three year construction period. The cash flow values shown are a result of using mean values and not the average of the Monte Carlo runs. The difference in after tax net present value between the two types of runs is less than 1 percent.

Table Y-4

DCF CASH FLOW RESULTS^a
 (3.0 Million Cow Plant)

Year	Gross Revenue	Depreciation	State Sev./ Income Tax	Taxable Income	Federal Tax	After Tax Value
1	0.	0.	0.	0.	0.	0.
2	0.	0.	0.	0.	0.	0.
3	0.	0.	0.	0.	0.	0.
4	86427000.	7010326.	264029.	6600715.	580437.	5361755.
5	86427000.	12017700.	63151.	1578770.	697185.	12482040.
6	86427000.	10173720.	136328.	3408197.	1505060.	11586360.
7	86427000.	8478097.	203570.	5089239.	2247408.	10762120.
8	86427000.	6920896.	265275.	6631864.	2928631.	10004550.
9	86427000.	5492775.	321816.	8045410.	3552853.	9309141.
10	86427000.	4184971.	373545.	9338629.	4123939.	8671670.
11	86427000.	2989266.	420790.	10519750.	4645522.	8088188.
12	86427000.	1897946.	463860.	11596490.	5121012.	7554982.
13	86427000.	903784.	503043.	12576060.	5553590.	7068557.
14	86427000.	0.	538610.	13465250.	5946254.	6625655.
15	86427000.	0.	538026.	13450660.	5939810.	6618021.
16	86427000.	0.	537443.	13436060.	5933366.	6610385.
17	86427000.	0.	536859.	13421460.	5926919.	6602744.
18	86427000.	0.	536274.	13406860.	5920468.	6595101.
19	86427000.	0.	535690.	13392250.	5914017.	6587457.
20	86427000.	0.	535106.	13377640.	5907566.	6579813.
21	86427000.	0.	534521.	13363030.	5901115.	6572170.
22	86427000.	0.	533937.	13348420.	5894661.	6564522.
23	86427000.	0.	533352.	13333790.	5888204.	13747410.

^aThe after tax net present value from the Monte Carlo analysis equals \$38,510,000, with a standard deviation of \$22,230,000. This is based upon the present value of the after tax flows shown less the present value of investment expended over the first three years of the time horizon (\$74,110,000 including the contingency factor). The analysis pertains only to the specific investment in question and, consequently, no tax liabilities or credits are applicable to the three year construction period. The cash flow values shown are a result of using mean values and not the average of the Monte Carlo runs. The difference in after tax net present value between the two types of runs is less than 1 percent.

Table Y-5

DCF CASH FLOW RESULTS^a
(3.5 Million Cow Plant)

Year	Gross Revenue	Depreciation	State Sev./ Income Tax	Taxable Income	Federal Tax	After Tax Value
1	0.	0.	0.	0.	0.	0.
2	0.	0.	0.	0.	0.	0.
3	0.	0.	0.	0.	0.	0.
4	100138500.	7304919.	315265.	7881626.	1047988.	5184334.
5	100138500.	12522720.	105874.	2646841.	1168845.	13481740.
6	100138500.	10601240.	182053.	4551325.	2009865.	12547460.
7	100138500.	8834370.	252048.	6301190.	2782606.	11687630.
8	100138500.	7211731.	316273.	7906829.	3491656.	10897280.
9	100138500.	5723596.	375118.	9377956.	4141306.	10171690.
10	100138500.	4360836.	428948.	10723700.	4735586.	9506481.
11	100138500.	3114883.	478106.	11952650.	5278289.	8897532.
12	100138500.	1977703.	522912.	13072810.	5772953.	8340964.
13	100138500.	941764.	563669.	14091730.	6222909.	7833149.
14	100138500.	0.	600659.	15016460.	6631271.	7370684.
15	100138500.	0.	599978.	14999440.	6623753.	7361776.
16	100138500.	0.	599296.	14982410.	6616232.	7352864.
17	100138500.	0.	598615.	14965380.	6608710.	7343951.
18	100138500.	0.	597933.	14948340.	6601186.	7335035.
19	100138500.	0.	597252.	14931290.	6593657.	7326114.
20	100138500.	0.	596570.	14914250.	6586132.	7317199.
21	100138500.	0.	595888.	14897210.	6578607.	7308283.
22	100138500.	0.	595206.	14880150.	6571076.	7299358.
23	100138500.	0.	594524.	14863100.	6563544.	15679400.

^aThe after tax net present value from the Monte Carlo analysis equals \$46,170,000, with a standard deviation of \$26,010,000. This is based upon the present value of the after tax flows shown less the present value of investment expended over the first three years of the time horizon (\$77,220,000 including the contingency factor). The analysis pertains only to the specific investment in question and, consequently, no tax liabilities or credits are applicable to the three year construction period. The cash flow values shown are a result of using mean values and not the average of the Monte Carlo runs. The difference in after tax net present value between the two types of runs is less than 1 percent.

Table Y-6

DCF CASH FLOW RESULTS^a
 (4.0 Million Cow Plant)

Year	Gross Revenue	Depreciation	State Sev./ Income Tax	Taxable Income	Federal Tax	After Tax Value
1	0.	0.	0.	0.	0.	0.
2	0.	0.	0.	0.	0.	0.
3	0.	0.	0.	0.	0.	0.
4	107316000.	8668038.	331869.	8296730.	777379.	6667500.
5	107316000.	14859500.	83488.	2087200.	921708.	15502140.
6	107316000.	12579470.	173966.	4349158.	1920588.	14394620.
7	107316000.	10482890.	257106.	6427654.	2838452.	13375450.
8	107316000.	8557461.	333400.	8335003.	3680738.	12438700.
9	107316000.	6791636.	403309.	10082730.	4452535.	11578810.
10	107316000.	5174581.	467268.	11681690.	5158636.	10790570.
11	107316000.	3696129.	525682.	13142060.	5803532.	10069080.
12	107316000.	2346749.	578934.	14473340.	6391427.	9409751.
13	107316000.	1117499.	627379.	15684490.	6926269.	8808269.
14	107316000.	0.	671355.	16783870.	7411758.	8260605.
15	107316000.	0.	670631.	16765770.	7403764.	8251133.
16	107316000.	0.	669906.	16747660.	7395765.	8241655.
17	107316000.	0.	669181.	16729540.	7387763.	8232173.
18	107316000.	0.	668457.	16711420.	7379762.	8222693.
19	107316000.	0.	667732.	16693290.	7371756.	8213207.
20	107316000.	0.	667006.	16675160.	7363751.	8203720.
21	107316000.	0.	666282.	16657040.	7355749.	8194239.
22	107316000.	0.	665556.	16638900.	7347740.	8184749.
23	107316000.	0.	664830.	16620750.	7339725.	17097390.

^aThe after tax net present value from the Monte Carlo analysis equals \$48,490,000, with a standard deviation of \$27,630,000. This is based upon the present value of the after tax flows shown less the present value of investment expended over the first three years of the time horizon (\$91,630,000 including the contingency factor). The analysis pertains only to the specific investment in question and, consequently, no tax liabilities or credits are applicable to the three year construction period. The cash flow values shown are a result of using mean values and not the average of the Monte Carlo runs. The difference in after tax net present value between the two types of runs is less than 1 percent.

Table Y-7

DCF CASH FLOW RESULTS^a
(4.5 Million Cow Plant)

Year	Gross Revenue	Depreciation	State Sev./ Income Tax	Taxable Income	Federal Tax	After Tax Value
1	0.	0.	0.	0.	0.	0.
2	0.	0.	0.	0.	0.	0.
3	0.	0.	0.	0.	0.	0.
4	112711500.	10560430.	341222.	8530549.	250468.	8978804.
5	112711500.	18103590.	38747.	968668.	427764.	18150490.
6	112711500.	15325790.	149110.	3727739.	1646170.	16802900.
7	112711500.	12771490.	250532.	6263300.	2765873.	15562940.
8	112711500.	10425710.	343614.	8590347.	3793497.	14423410.
9	112711500.	8274373.	428917.	10722930.	4735247.	13377520.
10	112711500.	6304284.	506971.	12674280.	5596961.	12418910.
11	112711500.	4503060.	578270.	14456760.	6384104.	11541640.
12	112711500.	2859086.	643279.	16081980.	7101802.	10740090.
13	112711500.	1361470.	702433.	17560830.	7754865.	10009020.
14	112711500.	0.	756141.	18903540.	8347802.	9343513.
15	112711500.	0.	755391.	18884780.	8339518.	9333696.
16	112711500.	0.	754640.	18866010.	8331230.	9323875.
17	112711500.	0.	753890.	18847240.	8322942.	9314054.
18	112711500.	0.	753138.	18828460.	8314647.	9304226.
19	112711500.	0.	752387.	18809670.	8306352.	9294396.
20	112711500.	0.	751636.	18790900.	8298060.	9284573.
21	112711500.	0.	750884.	18772110.	8289765.	9274743.
22	112711500.	0.	750133.	18753320.	8281467.	9264910.
23	112711500.	0.	749381.	18734530.	8273167.	18500060.

^aThe after tax net present value from the Monte Carlo analysis equals \$49,720,000, with a standard deviation of \$28,610,000. This is based upon the present value of the after tax flows shown less the present value of investment expended over the first three years of the time horizon (\$11,600,000 including the contingency factor). The analysis pertains only to the specific investment in question and, consequently, no tax liabilities or credits are applicable to the three year construction period. The cash flow values shown are a result of using mean values and not the average of the Monte Carlo runs. The difference in after tax net present value between the two types of runs is less than 1 percent.

Table Y-8

DCF CASH FLOW RESULTS^a
(5.0 Million Cow Plant)

Year	Gross Revenue	Depreciation	State Sev./ Income Tax	Taxable Income	Federal Tax	After Tax Value
1	0.	0.	0.	0.	0.	0.
2	0.	0.	0.	0.	0.	0.
3	0.	0.	0.	0.	0.	0.
4	114345000.	11084700.	345963.	8649080.	128228.	9638365.
5	114345000.	19002350.	28501.	712514.	314646.	18911640.
6	114345000.	16086650.	144372.	3609291.	1593863.	17497530.
7	114345000.	13405540.	250859.	6271470.	2769481.	16196410.
8	114345000.	10943300.	348591.	8714774.	3848444.	15000680.
9	114345000.	8685157.	438159.	10953970.	4837274.	13903250.
10	114345000.	6617263.	520117.	13002910.	5742087.	12897430.
11	114345000.	4726617.	594985.	14874620.	6568631.	11976990.
12	114345000.	3001027.	663250.	16581260.	7322286.	11136030.
13	114345000.	1429060.	725371.	18134270.	8008093.	10369050.
14	114345000.	0.	781774.	19544360.	8630790.	9670889.
15	114345000.	0.	781016.	19525400.	8622417.	9660968.
16	114345000.	0.	780257.	19506430.	8614041.	9651042.
17	114345000.	0.	779499.	19487460.	8605664.	9641117.
18	114345000.	0.	778740.	19468490.	8597284.	9631189.
19	114345000.	0.	777980.	19449500.	8588901.	9621254.
20	114345000.	0.	777221.	19430530.	8580521.	9611327.
21	114345000.	0.	776462.	19411540.	8572138.	9601391.
22	114345000.	0.	775702.	19392560.	8563755.	9591460.
23	114345000.	0.	774942.	19373560.	8555362.	18924320.

^aThe after tax net present value from the Monte Carlo analysis equals \$50,410,000, with a standard deviation of \$28,940,000. This is based upon the present value of the after tax flows shown less the present value of investment expended over the first three years of the time horizon (\$117,200,000 including the contingency factor). The analysis pertains only to the specific investment in question and, consequently, no tax liabilities or credits are applicable to the three year construction period. The cash flow values shown are a result of using mean values and not the average of the Monte Carlo runs. The difference in after tax net present value between the two types of runs is less than 1 percent.

Table Y-9

DCF CASH FLOW RESULTS^a
(5.5 Million Cow Plant)

Year	Gross Revenue	Depreciation	State Sev./ Income Tax	Taxable Income	Federal Tax	After Tax Value
1	0.	0.	0.	0.	0.	0.
2	0.	0.	0.	0.	0.	0.
3	0.	0.	0.	0.	0.	0.
4	118156500.	13456430.	352038.	8800962.	-594487.	12747640.
5	118156500.	23068170.	-33198.	-829960.	-366510.	22171570.
6	118156500.	19528610.	107617.	2690416.	1188088.	20456890.
7	118156500.	16273840.	237040.	5925992.	2616918.	18879350.
8	118156500.	13284770.	355835.	8895871.	3928417.	17429770.
9	118156500.	10543470.	464719.	11617970.	5130497.	16099510.
10	118156500.	8033119.	564365.	14109110.	6230585.	14880480.
11	118156500.	5737942.	655404.	16385090.	7235656.	13765070.
12	118156500.	3643138.	738427.	18460690.	8152239.	12746160.
13	118156500.	1734828.	813991.	20349780.	8986463.	11817070.
14	118156500.	0.	882615.	22065380.	9744074.	10971510.
15	118156500.	0.	881847.	22046170.	9735588.	10961460.
16	118156500.	0.	881078.	22026940.	9727099.	10951400.
17	118156500.	0.	880308.	22007710.	9718606.	10941340.
18	118156500.	0.	879539.	21988480.	9710113.	10931270.
19	118156500.	0.	878770.	21969240.	9701617.	10921210.
20	118156500.	0.	878000.	21950000.	9693120.	10911140.
21	118156500.	0.	877230.	21930760.	9684624.	10910170.
22	118156500.	0.	876460.	21911510.	9676124.	10891000.
23	118156500.	0.	875690.	21892260.	9667622.	20350920.

^aThe after tax net present value from the Monte Carlo analysis equals \$51,200,000, with a standard deviation of \$29,370,000. This is based upon the present value of the after tax flows shown less the present value of investment expended over the first three years of the time horizon (\$142,300,000 including the contingency factor). The analysis pertains only to the specific investment in question and, consequently, no tax liabilities or credits are applicable to the three year construction period. The cash flow values shown are a result of using mean values and not the average of the Monte Carlo runs. The difference in after tax net present value between the two types of runs is less than 1 percent.

Table Y-10

DCF CASH FLOW RESULTS^a
(6.0 Million Cow Plant)

Year	Gross Revenue	Depreciation	State Sev./ Income Tax	Taxable Income	Federal Tax	After Tax Value
1	0.	0.	0.	0.	0.	0.
2	0.	0.	0.	0.	0.	0.
3	0.	0.	0.	0.	0.	0.
4	127710000.	14140490.	381869.	9546723.	-492949.	13219970.
5	127710000.	24240840.	-22977.	-574436.	-253671.	23437200.
6	127710000.	20521340.	124970.	3124252.	1379670.	21635010.
7	127710000.	17101120.	260946.	6523658.	2880848.	19976940.
8	127710000.	13960100.	385754.	9643862.	4258730.	18453330.
9	127710000.	11079440.	500147.	12503690.	5521628.	17055100.
10	127710000.	8441481.	604833.	15120820.	6677352.	15773760.
11	127710000.	6029630.	700473.	17511830.	7733226.	14601310.
12	127710000.	3828336.	787692.	19692300.	8696118.	13530270.
13	127710000.	1823017.	867071.	21676770.	9572464.	12553600.
14	127710000.	0.	939157.	23478940.	10368300.	11664730.
15	127710000.	0.	938324.	23458100.	10359100.	11653820.
16	127710000.	0.	937490.	23437240.	10349890.	11642910.
17	127710000.	0.	936655.	23416380.	10340680.	11631990.
18	127710000.	0.	935820.	23395510.	10331460.	11621070.
19	127710000.	0.	934986.	23374650.	10322250.	11610160.
20	127710000.	0.	934151.	23353780.	10313030.	11599230.
21	127710000.	0.	933316.	23332910.	10303810.	11588320.
22	127710000.	0.	932481.	23312030.	10294590.	11577390.
23	127710000.	0.	931645.	23291140.	10285370.	21838650.

^aThe after tax net present value from the Monte Carlo analysis equals \$55,560,000, with a standard deviation of \$31,860,000. This is based upon the present value of the after tax flows shown less the present value of investment expended over the first three years of the time horizon (\$149,500,000 including the contingency factor). The analysis pertains only to the specific investment in question and, consequently, no tax liabilities or credits are applicable to the three year construction period. The cash flow values shown are a result of using mean values and not the average of the Monte Carlo runs. The difference in after tax net present value between the two types of runs is less than 1 percent.

Table Y-11

DCF CASH FLOW RESULTS^a
 (6.5 Million Cow Plant)

Year	Gross Revenue	Depreciation	State Sev./ Income Tax	Taxable Income	Federal Tax	After Tax Value
1	0.	0.	0.	0.	0.	0.
2	0.	0.	0.	0.	0.	0.
3	0.	0.	0.	0.	0.	0.
4	124195500.	14799580.	357585.	8939614.	-980526.	14146510.
5	124195500.	25370700.	-66064.	-1651600.	-729347.	24026010.
6	124195500.	21477850.	88846.	2221162.	980865.	22140700.
7	124195500.	17898200.	231228.	5780700.	2552757.	20406220.
8	124195500.	14610780.	361921.	9048020.	3995606.	18812480.
9	124195500.	11595860.	481713.	12042820.	5318111.	17349960.
10	124195500.	8834940.	591345.	14783630.	6528450.	16009780.
11	124195500.	6310672.	691511.	17287780.	7634282.	14783570.
12	124195500.	4006776.	782862.	19571560.	8642801.	13663490.
13	124195500.	1907989.	866009.	21650220.	9560737.	12642180.
14	124195500.	0.	941523.	23538060.	10394410.	11712750.
15	124195500.	0.	940717.	23517940.	10385520.	11702220.
16	124195500.	0.	939912.	23497800.	10376630.	11691680.
17	124195500.	0.	939106.	23477660.	10367730.	11681140.
18	124195500.	0.	938300.	23457500.	10358830.	11670600.
19	124195500.	0.	937494.	23437350.	10349940.	11660050.
20	124195500.	0.	936688.	23417200.	10341040.	11649510.
21	124195500.	0.	935882.	23397050.	10332140.	11638960.
22	124195500.	0.	935075.	23376880.	10323230.	11628410.
23	124195500.	0.	934268.	23356710.	10314320.	21537860.

^aThe after tax net present value from the Monte Carlo analysis equals \$51,770,000, with a standard deviation of \$30,610,000. This is based upon the present value of the after tax flows shown less the present value of investment expended over the first three years of the time horizon (\$156,500,000 including the contingency factor). The analysis pertains only to the specific investment in question and, consequently, no tax liabilities or credits are applicable to the three year construction period. The cash flow values shown are a result of using mean values and not the average of the Monte Carlo runs. The difference in after tax net present value between the two types of runs is less than 1 percent.

Table Y-12

DCF CASH FLOW RESULTS^a
(7.0 Million Cow Plant)

Year	Gross Revenue	Depreciation	State Sev./ Income Tax	Taxable Income	Federal Tax	After Tax Value
1	0.	0.	0.	0.	0.	0.
2	0.	0.	0.	0.	0.	0.
3	0.	0.	0.	0.	0.	0.
4	136521000.	16986560.	398550.	9963760.	-1256528.	16665810.
5	136521000.	29119820.	-87656.	-2191412.	-967728.	27450970.
6	136521000.	24651700.	90192.	2254792.	995716.	25287650.
7	136521000.	20543080.	253659.	6341478.	2800397.	23297470.
8	136521000.	16769860.	403711.	10092770.	4456967.	21468810.
9	136521000.	13309420.	541251.	13531270.	5975410.	19790780.
10	136521000.	10140510.	667130.	16678240.	7365113.	18253150.
11	136521000.	7243221.	782144.	19553590.	8634865.	16846340.
12	136521000.	4598870.	887040.	22175990.	9792919.	15561340.
13	136521000.	2189938.	982519.	24562970.	10847010.	14389710.
14	136521000.	0.	1069238.	26730940.	11804390.	13323540.
15	136521000.	0.	1068360.	26708990.	11794690.	13312050.
16	136521000.	0.	1067481.	26687020.	11784990.	13300560.
17	136521000.	0.	1066602.	26665060.	11775290.	13289060.
18	136521000.	0.	1065723.	26643070.	11765580.	13277560.
19	136521000.	0.	1064844.	26621100.	11755880.	13266060.
20	136521000.	0.	1063965.	26599110.	11746170.	13254560.
21	136521000.	0.	1063085.	26577130.	11736460.	13243050.
22	136521000.	0.	1062205.	26555140.	11726750.	13231550.
23	136521000.	0.	1061325.	26533130.	11717030.	24040080.

^aThe after tax net present value from the Monte Carlo analysis equals \$57,810,000, with a standard deviation of \$33,520,000. This is based upon the present value of the after tax flows shown less the present value of investment expended over the first three years of the time horizon (\$179,600,000 including the contingency factor). The analysis pertains only to the specific investment in question and, consequently, no tax liabilities or credits are applicable to the three year construction period. The cash flow values shown are a result of using mean values and not the average of the Monte Carlo runs. The difference in after tax net present value between the two types of runs is less than 1 percent.

Appendix Z

FEED RATIONS AND COSTS PER COW BY PRODUCTION PERIOD, HAY TYPE,
ANNUAL MILK PRODUCTION, bGH RESPONSE AND FORAGE COMPOSITION
WITH NORMAL INTAKE

Ration Ingredients and Costs	Production Period				
	Early	Mid	Late	Dry	Total
13,000# Production, Mixed Mainly Legume Forage All Hay Ration (No bGH)					
Corn Silage (tons)	0.00	0.00	0.00	0.00	0.00
Corn Grain (bu)	15.88	18.75	0.00	0.00	34.63
Mixed Mainly Legume (tons)	1.63	2.16	1.76	0.68	6.23
Soy-44 (cwt)	0.00	0.00	0.00	0.00	0.00
Premix (cwt)	0.28	0.36	0.24	0.10	0.98
Cost (\$)	173.92	222.11	127.25	50.15	573.43
Purchase Price (\$)	61.51	73.19	5.54	2.95	143.19
13,000# Production, Mixed Mainly Legume Forage All Hay Ration (10 Percent bGH Response)					
Corn Silage (tons)	0.00	0.00	0.00	0.00	0.00
Corn Grain (bu)	15.88	25.05	0.00	0.00	40.93
Mixed Mainly Legume (tons)	1.63	2.06	1.87	0.68	6.23
Soy-44 (cwt)	0.00	0.30	0.00	0.00	0.30
Premix (cwt)	0.28	0.38	0.25	0.10	1.01
Cost (\$)	173.92	243.05	134.48	50.15	601.60
Purchase Price (\$)	61.51	100.97	5.77	2.95	171.20
13,000# Production, Mixed Mainly Legume Forage All Hay Ration (20 Percent bGH Response)					
Corn Silage (tons)	0.00	0.00	0.00	0.00	0.00
Corn Grain (bu)	15.88	30.30	1.75	0.00	47.93
Mixed Mainly Legume (tons)	1.63	1.94	1.88	0.68	6.13
Soy-44 (cwt)	0.00	1.57	0.00	0.00	1.57
Premix (cwt)	0.28	0.39	0.25	0.10	1.02
Cost (\$)	173.93	274.90	141.32	50.15	640.30
Purchase Price (\$)	61.51	140.99	11.77	2.95	217.22

Appendix Z Cont.

Ration Ingredients and Costs	Production Period				
	Early	Mid	Late	Dry	Total
13,000# Production, Mixed Mainly Legume Forage All Hay Ration (30 Percent bGH Response)					
Corn Silage (tons)	0.00	0.00	0.00	0.00	0.00
Corn Grain (bu)	15.88	35.39	4.61	0.00	55.88
Mixed Mainly Legume (tons)	1.63	1.84	1.82	0.68	5.97
Soy-44 (cwt)	0.00	2.76	0.00	0.00	2.76
Premix (cwt)	0.28	0.41	0.25	0.10	1.04
Cost (\$)	173.92	305.97	146.80	50.15	676.84
Purchase Price (\$)	61.51	179.15	21.26	2.95	264.87
13,000# Production, Mixed Mainly Legume Forage All Hay Ration (40 Percent bGH Response)					
Corn Silage (tons)	0.00	0.00	0.00	0.00	0.00
Corn Grain (bu)	15.88	41.88	7.59	0.00	65.35
Mixed Mainly Legume (tons)	1.63	1.66	1.80	0.68	5.77
Soy-44 (cwt)	0.00	4.32	0.00	0.00	4.32
Premix (cwt)	0.28	0.50	0.25	0.10	1.13
Cost (\$)	173.92	342.90	155.88	50.15	722.85
Purchase Price (\$)	61.51	228.48	31.72	2.95	324.66
13,000# Production, Mixed Mainly Legume Forage 50/50 Ration (No bGH)					
Corn Silage (tons)	2.50	3.33	2.25	0.81	8.88
Corn Grain (bu)	2.59	1.46	0.00	0.00	4.05
Mixed Mainly Legume (tons)	0.95	1.26	0.85	0.31	3.37
Soy-44 (cwt)	2.14	2.48	0.00	0.00	4.62
Premix (cwt)	0.29	0.38	0.26	0.08	1.01
Cost (\$)	172.38	215.88	113.64	41.30	543.20
Purchase Price (\$)	51.86	55.64	5.47	2.36	115.33
13,000# Production, Mixed Mainly Legume Forage 50/50 Ration (10 Percent bGH Response)					
Corn Silage (tons)	2.50	3.13	2.42	0.81	8.86
Corn Grain (bu)	2.59	8.05	0.00	0.00	10.64
Mixed Mainly Legume (tons)	0.95	1.19	0.92	0.31	3.36
Soy-44 (cwt)	2.14	3.59	0.00	0.00	5.73
Premix (cwt)	0.29	0.43	0.27	0.08	1.07
Cost (\$)	172.38	248.23	122.02	41.30	583.93
Purchase Price (\$)	51.86	97.53	5.68	2.36	157.43

Appendix Z Cont.

Ration Ingredients and Costs	Production Period				
	Early	Mid	Late	Dry	Total
13,000# Production, Mixed Mainly Legume Forage 50/50 Ration (20 Percent bGH Response)					
Corn Silage (tons)	2.50	2.90	2.53	0.81	8.75
Corn Grain (bu)	2.59	15.07	0.00	0.00	17.66
Mixed Mainly Legume (tons)	0.95	1.10	0.96	0.31	3.32
Soy-44 (cwt)	2.14	4.73	0.10	0.00	6.97
Premix (cwt)	0.29	0.56	0.28	0.08	1.21
Cost (\$)	172.38	281.61	129.57	41.30	624.86
Purchase Price (\$)	51.86	141.63	7.58	2.36	203.43
13,000# Production, Mixed Mainly Legume Forage 50/50 Ration (30 Percent bGH Response)					
Corn Silage (tons)	2.50	2.71	2.53	0.81	8.56
Corn Grain (bu)	2.59	21.70	0.00	0.00	24.29
Mixed Mainly Legume (tons)	0.95	1.03	0.96	0.31	3.25
Soy-44 (cwt)	2.14	5.81	0.51	0.00	8.46
Premix (cwt)	0.29	0.66	0.28	0.08	1.31
Cost (\$)	172.38	314.10	136.71	41.30	664.49
Purchase Price (\$)	51.86	183.43	14.61	2.36	252.26
13,000# Production, Mixed Mainly Legume Forage 50/50 Ration (40 Percent bGH Response)					
Corn Silage (tons)	2.50	2.42	2.59	0.81	8.32
Corn Grain (bu)	2.59	30.08	0.00	0.00	32.67
Mixed Mainly Legume (tons)	0.95	0.92	0.98	0.31	3.16
Soy-44 (cwt)	2.14	7.11	0.93	0.00	10.18
Premix (cwt)	0.29	0.79	0.29	0.08	1.45
Cost (\$)	172.38	351.69	146.86	41.30	712.23
Purchase Price (\$)	51.86	235.13	21.96	2.36	311.31
13,000# Production, Mixed Mainly Legume Forage 75/25 Ration (no bGH)					
Corn Silage (tons)	3.70	4.81	3.54	1.37	13.42
Corn Grain (bu)	0.00	0.00	0.00	0.00	0.00
Mixed Mainly Legume (tons)	0.47	0.61	0.45	0.17	1.70
Soy-44 (cwt)	3.36	4.76	0.83	0.00	8.95
Premix (cwt)	0.50	0.63	0.34	0.11	1.58
Cost (\$)	185.78	237.17	123.33	44.84	591.12
Purchase Price (\$)	72.04	89.34	19.66	2.36	183.40

Appendix Z Cont.

Ration Ingredients and Costs	Production Period				
	Early	Mid	Late	Dry	Total
13,000# Production, Mixed Mainly Legume Forage 75/25 Ration (10 Percent bGH Response)					
Corn Silage (tons)	3.70	4.90	3.56	1.37	13.53
Corn Grain (bu)	0.00	0.00	0.00	0.00	0.00
Mixed Mainly Legume (tons)	0.47	0.62	0.45	0.17	1.71
Soy-44 (cwt)	3.36	5.71	1.40	0.00	10.47
Premix (cwt)	0.50	0.68	0.37	0.11	1.66
Cost (\$)	185.78	256.48	138.77	44.84	625.87
Purchase Price (\$)	72.04	105.83	29.49	2.36	209.72
13,000# Production, Mixed Mainly Legume Forage 75/25 Ration (20 Percent bGH Response)					
Corn Silage (tons)	3.70	4.63	3.61	1.37	13.32
Corn Grain (bu)	0.00	6.30	0.00	0.00	6.30
Mixed Mainly Legume (tons)	0.47	0.59	0.46	0.17	1.68
Soy-44 (cwt)	3.36	6.69	1.81	0.00	11.86
Premix (cwt)	0.50	0.76	0.39	0.11	1.76
Cost (\$)	185.78	287.11	147.60	44.84	665.33
Purchase Price (\$)	72.04	144.31	36.65	2.36	255.36
13,000# Production, Mixed Mainly Legume Forage 75/25 Ration (30 Percent bGH Response)					
Corn Silage (tons)	3.70	4.31	3.61	1.37	12.99
Corn Grain (bu)	0.00	13.71	0.00	0.00	13.71
Mixed Mainly Legume (tons)	0.47	0.55	0.46	0.17	1.65
Soy-44 (cwt)	3.36	7.64	2.23	0.00	13.23
Premix (cwt)	0.50	0.86	0.41	0.11	1.88
Cost (\$)	185.78	319.50	154.79	44.84	704.91
Purchase Price (\$)	72.04	187.10	43.83	2.36	305.33
13,000# Production, Mixed Mainly Legume Forage 75/25 Ration (40 Percent bGH Response)					
Corn Silage (tons)	3.70	3.83	3.69	1.37	12.59
Corn Grain (bu)	0.00	23.18	0.00	0.00	23.18
Mixed Mainly Legume (tons)	0.47	0.48	0.47	0.17	1.59
Soy-44 (cwt)	3.36	8.74	2.69	0.00	14.79
Premix (cwt)	0.50	0.96	0.44	0.11	2.01
Cost (\$)	185.78	356.97	165.39	44.84	752.98
Purchase Price (\$)	72.04	239.16	51.97	2.36	365.53

Appendix Z Cont.

Ration Ingredients and Costs	Production Period				
	Early	Mid	Late	Dry	Total
13,000# Production, Mixed Mainly Grass Forage All Hay Ration (No bGH)					
Corn Silage (tons)	0.00	0.00	0.00	0.00	0.00
Corn Grain (bu)	19.86	24.39	2.82	0.00	47.07
Mixed Mainly Grass (tons)	1.36	1.82	1.72	0.71	5.61
Soy-44 (cwt)	2.38	2.78	0.00	0.00	5.16
Premix (cwt)	0.50	0.64	0.45	0.15	1.74
Cost (\$)	202.18	255.31	123.84	46.61	627.97
Purchase Price (\$)	117.62	142.75	16.92	2.95	280.24
13,000# Production, Mixed Mainly Grass Forage All Hay Ration (10 Percent bGH Response)					
Corn Silage (tons)	0.00	0.00	0.00	0.00	0.00
Corn Grain (bu)	19.86	29.68	6.50	0.00	56.04
Mixed Mainly Grass (tons)	1.36	1.70	1.66	0.71	5.43
Soy-44 (cwt)	2.38	3.33	0.00	0.00	5.71
Premix (cwt)	0.50	0.71	0.46	0.15	1.82
Cost (\$)	202.18	285.70	133.06	46.61	667.55
Purchase Price (\$)	117.62	180.10	30.09	2.95	330.24
13,000# Production, Mixed Mainly Grass Forage All Hay Ration (20 Percent bGH Response)					
Corn Silage (tons)	0.00	0.00	0.00	0.00	0.00
Corn Grain (bu)	19.86	35.16	9.11	0.00	64.13
Mixed Mainly Grass (tons)	1.36	1.58	1.64	0.71	5.29
Soy-44 (cwt)	2.38	5.00	0.00	0.00	7.38
Premix (cwt)	0.50	0.81	0.46	0.15	1.92
Cost (\$)	202.18	316.37	140.98	46.61	706.14
Purchase Price (\$)	117.62	218.27	39.53	2.95	378.37
13,000# Production, Mixed Mainly Grass Forage All Hay Ration (30 Percent bGH Response)					
Corn Silage (tons)	0.00	0.00	0.00	0.00	0.00
Corn Grain (bu)	19.86	40.43	11.21	0.00	71.50
Mixed Mainly Grass (tons)	1.36	1.48	1.58	0.71	5.13
Soy-44 (cwt)	2.38	6.06	0.49	0.00	8.93
Premix (cwt)	0.50	0.90	0.46	0.15	2.01
Cost (\$)	202.18	346.52	152.71	46.61	748.02
Purchase Price (\$)	117.62	254.91	55.07	2.95	430.55

Appendix Z Cont.

Ration Ingredients and Costs	Production Period				
	Early	Mid	Late	Dry	Total
13,000# Production, Mixed Mainly Grass Forage All Hay Ration (40 Percent bGH Response)					
Corn Silage (tons)	0.00	0.00	0.00	0.00	0.00
Corn Grain (bu)	19.86	46.79	13.61	0.00	80.26
Mixed Mainly Grass (tons)	1.36	1.32	1.55	0.71	4.94
Soy-44 (cwt)	2.38	7.33	0.99	0.00	10.70
Premix (cwt)	0.50	1.00	0.46	0.15	2.11
Cost (\$)	202.18	380.56	167.91	46.61	797.26
Purchase Price (\$)	117.62	298.82	72.02	2.95	491.41
13,000# Production, Mixed Mainly Grass Forage 50/50 Ration (No bGH)					
Corn Silage (tons)	2.23	2.97	2.37	0.89	8.45
Corn Grain (bu)	6.57	6.59	0.00	0.00	13.16
Mixed Mainly Grass (tons)	0.84	1.11	0.89	0.33	3.17
Soy-44 (cwt)	3.69	4.53	0.63	0.00	8.85
Premix (cwt)	0.56	0.71	0.41	0.14	1.82
Cost (\$)	193.90	244.17	124.37	43.07	605.51
Purchase Price (\$)	93.15	109.80	17.30	2.95	223.20
13,000# Production, Mixed Mainly Grass Forage 50/50 Ration (10 Percent bGH Response)					
Corn Silage (tons)	2.23	2.77	2.38	0.89	8.27
Corn Grain (bu)	6.57	13.27	0.00	0.00	19.84
Mixed Mainly Grass (tons)	0.84	1.04	0.89	0.33	3.10
Soy-44 (cwt)	3.69	5.53	1.20	0.00	10.42
Premix (cwt)	0.56	0.80	0.44	0.14	1.94
Cost (\$)	193.90	275.66	134.80	43.07	647.43
Purchase Price (\$)	93.15	150.24	27.11	2.95	273.45
13,000# Production, Mixed Mainly Grass Forage 50/50 Ration (20 Percent bGH Response)					
Corn Silage (tons)	2.23	2.57	2.42	0.89	8.11
Corn Grain (bu)	6.57	20.02	0.00	0.00	26.59
Mixed Mainly Grass (tons)	0.84	0.96	0.91	0.33	3.04
Soy-44 (cwt)	3.69	6.53	1.61	0.00	11.82
Premix (cwt)	0.56	0.89	0.47	0.14	2.05
Cost (\$)	193.90	307.40	143.56	43.07	687.90
Purchase Price (\$)	93.15	191.40	34.24	2.95	321.71

Appendix Z Cont.

Ration Ingredients and Costs	Production Period				
	Early	Mid	Late	Dry	Total
13,000# Production, Mixed Mainly Grass Forage 50/50 Ration (30 Percent bGH Response)					
Corn Silage (tons)	2.23	2.40	2.42	0.89	7.93
Corn Grain (bu)	6.57	26.45	0.00	0.00	33.02
Mixed Mainly Grass (tons)	0.84	0.90	0.91	0.33	2.97
Soy-44 (cwt)	3.69	7.49	2.02	0.00	13.20
Premix (cwt)	0.56	0.97	0.49	0.14	2.16
Cost (\$)	193.90	338.44	150.75	43.07	726.16
Purchase Price (\$)	93.15	230.02	41.41	2.95	367.53
13,000# Production, Mixed Mainly Grass Forage 50/50 Ration (40 Percent bGH Response)					
Corn Silage (tons)	2.23	2.13	2.47	0.89	7.72
Corn Grain (bu)	6.57	34.46	0.00	0.00	41.04
Mixed Mainly Grass (tons)	0.84	0.80	0.93	0.33	2.89
Soy-44 (cwt)	3.69	8.61	2.48	0.00	14.78
Premix (cwt)	0.56	1.06	0.52	0.14	2.28
Cost (\$)	193.90	373.65	161.24	43.02	771.81
Purchase Price (\$)	93.15	277.19	49.49	2.95	422.78
13,000# Production, Mixed Mainly Grass Forage 75/25 Ration (no bGH)					
Corn Silage (tons)	3.61	4.67	3.45	1.48	13.21
Corn Grain (bu)	0.00	0.00	0.00	0.00	0.00
Mixed Mainly Grass (tons)	0.45	0.59	0.43	0.18	1.65
Soy-44 (cwt)	4.58	5.71	1.53	0.00	11.82
Premix (cwt)	0.64	0.32	0.48	0.17	1.61
Cost (\$)	192.54	245.96	134.73	46.61	619.84
Purchase Price (\$)	85.12	106.33	32.12	2.95	226.52
13,000# Production, Mixed Mainly Grass Forage 75/25 Ration (10 Percent bGH Response)					
Corn Silage (tons)	3.61	4.68	3.47	1.48	13.24
Corn Grain (bu)	0.00	1.95	0.00	0.00	1.95
Mixed Mainly Grass (tons)	0.45	0.58	0.43	0.18	1.65
Soy-44 (cwt)	4.58	6.65	2.10	0.00	13.33
Premix (cwt)	0.64	0.85	0.51	0.17	2.17
Cost (\$)	192.54	268.82	145.24	46.61	653.21
Purchase Price (\$)	85.12	129.67	42.03	2.95	259.77

Appendix Z Cont.

Ration Ingredients and Costs	Production Period				
	Early	Mid	Late	Dry	Total
13,000# Production, Mixed Mainly Grass Forage 75/25 Ration (20 Percent bGH Response)					
Corn Silage (tons)	3.61	4.33	3.52	1.48	12.94
Corn Grain (bu)	0.00	9.66	0.00	0.00	9.66
Mixed Mainly Grass (tons)	0.45	0.54	0.44	0.18	1.61
Soy-44 (cwt)	4.58	7.57	2.52	0.00	14.67
Premix (cwt)	0.64	0.93	0.54	0.17	2.28
Cost (\$)	192.54	301.27	154.18	46.61	694.60
Purchase Price (\$)	85.12	172.39	49.40	2.95	309.86
13,000# Production, Mixed Mainly Grass Forage 75/25 Ration (30 Percent bGH Response)					
Corn Silage (tons)	3.61	4.03	3.52	1.48	12.64
Corn Grain (bu)	0.00	16.91	0.00	0.00	16.91
Mixed Mainly Grass (tons)	0.45	0.50	0.44	0.18	1.58
Soy-44 (cwt)	4.58	8.46	2.94	0.00	15.98
Premix (cwt)	0.64	1.02	0.56	0.17	2.39
Cost (\$)	192.54	332.93	161.39	46.61	733.47
Purchase Price (\$)	85.12	213.04	56.59	2.95	357.70
13,000# Production, Mixed Mainly Grass Forage 75/25 Ration (40 Percent bGH Response)					
Corn Silage (tons)	3.61	3.58	3.60	1.48	12.27
Corn Grain (bu)	0.00	26.10	0.00	0.00	26.10
Mixed Mainly Grass (tons)	0.45	0.45	0.45	0.18	1.53
Soy-44 (cwt)	4.58	9.47	3.42	0.00	17.47
Premix (cwt)	0.64	1.10	0.59	0.17	2.50
Cost (\$)	192.54	368.96	172.13	46.61	780.24
Purchase Price (\$)	85.12	262.52	65.01	2.95	415.60
16,000# Production, Mixed Mainly Legume Forage All Hay Ration (No bGH)					
Corn Silage (tons)	0.00	0.00	0.00	0.00	0.00
Corn Grain (bu)	26.64	32.05	2.64	0.00	61.32
Mixed Mainly Legume (tons)	1.40	1.88	1.89	0.68	5.86
Soy-44 (cwt)	2.02	2.02	0.00	0.00	4.04
Premix (cwt)	0.31	0.40	0.26	0.10	1.06
Cost (\$)	230.75	284.80	145.22	50.15	710.92
Purchase Price (\$)	133.92	154.81	14.79	2.95	306.47

Appendix Z Cont.

Ration Ingredients and Costs	Production Period				
	Early	Mid	Late	Dry	Total
16,000# Production, Mixed Mainly Legume Forage All Hay Ration (10 Percent bGH Response)					
Corn Silage (tons)	0.00	0.00	0.00	0.00	0.00
Corn Grain (bu)	26.64	38.53	6.31	0.00	71.47
Mixed Mainly Legume (tons)	1.40	1.74	1.80	0.68	5.62
Soy-44 (cwt)	2.02	3.54	0.00	0.00	5.56
Premix (cwt)	0.31	0.42	0.25	0.10	1.07
Cost (\$)	230.75	323.28	151.47	50.15	755.65
Purchase Price (\$)	133.92	203.46	27.01	2.95	367.34
16,000# Production, Mixed Mainly Legume Forage All Hay Ration (20 Percent bGH Response)					
Corn Silage (tons)	0.00	0.00	0.00	0.00	0.00
Corn Grain (bu)	26.64	46.37	10.16	0.00	83.18
Mixed Mainly Legume (tons)	1.40	1.52	1.75	0.68	5.35
Soy-44 (cwt)	2.02	5.41	0.00	0.00	7.43
Premix (cwt)	0.31	0.62	0.26	0.10	1.29
Cost (\$)	230.75	367.40	161.91	50.15	810.21
Purchase Price (\$)	133.92	262.84	40.97	2.95	440.68
16,000# Production, Mixed Mainly Legume Forage All Hay Ration (30 Percent bGH Response)					
Corn Silage (tons)	0.00	0.00	0.00	0.00	0.00
Corn Grain (bu)	26.64	53.77	14.08	0.00	94.50
Mixed Mainly Legume (tons)	1.40	1.36	1.70	0.68	5.15
Soy-44 (cwt)	2.02	7.03	0.00	0.00	9.04
Premix (cwt)	0.31	0.78	0.28	0.10	1.47
Cost (\$)	230.75	410.80	172.45	50.15	864.15
Purchase Price (\$)	133.92	316.73	55.13	2.95	508.73
16,000# Production, Mixed Mainly Legume Forage All Hay Ration (40 Percent bGH Response)					
Corn Silage (tons)	0.00	0.00	0.00	0.00	0.00
Corn Grain (bu)	26.64	56.75	18.07	0.00	101.46
Mixed Mainly Legume (tons)	1.40	1.22	1.65	0.68	4.95
Soy-44 (cwt)	2.02	7.46	0.00	0.00	9.48
Premix (cwt)	0.31	0.93	0.29	0.10	1.63
Cottonseed (cwt)	0.00	2.06	0.00	0.00	2.06
Cost (\$)	230.75	461.78	183.08	50.15	925.76
Purchase Price (\$)	133.92	377.30	69.52	2.95	583.69

Appendix Z Cont.

Ration Ingredients and Costs	Production Period				
	Early	Mid	Late	Dry	Total
16,000# Production, Mixed Mainly Legume Forage 50/50 Ration (No bGH)					
Corn Silage (tons)	2.08	2.80	2.51	0.81	8.20
Corn Grain (bu)	16.10	17.56	0.00	0.00	33.66
Mixed Mainly Legume (tons)	0.79	1.06	0.95	0.31	3.11
Soy-44 (cwt)	4.34	5.12	0.00	0.00	9.46
Premix (cwt)	0.50	0.60	0.28	0.08	1.45
Cost (\$)	236.78	292.02	126.65	41.30	696.75
Purchase Price (\$)	136.81	156.93	5.84	2.36	301.94
16,000# Production, Mixed Mainly Legume Forage 50/50 Ration (10 Percent bGH Response)					
Corn Silage (tons)	2.08	2.54	2.56	0.81	7.99
Corn Grain (bu)	16.10	26.02	0.00	0.00	42.11
Mixed Mainly Legume (tons)	0.79	0.96	0.97	0.31	3.03
Soy-44 (cwt)	4.34	6.46	0.76	0.00	11.56
Premix (cwt)	0.50	0.73	0.29	0.08	1.59
Cost (\$)	236.78	332.09	142.33	41.30	752.50
Purchase Price (\$)	136.81	209.77	18.96	2.36	367.90
16,000# Production, Mixed Mainly Legume Forage 50/50 Ration (20 Percent bGH Response)					
Corn Silage (tons)	2.08	2.20	2.60	0.81	7.69
Corn Grain (bu)	16.10	35.76	0.00	0.00	51.86
Mixed Mainly Legume (tons)	0.79	0.84	0.99	0.31	2.92
Soy-44 (cwt)	4.34	7.96	1.29	0.00	13.60
Premix (cwt)	0.50	0.88	0.29	0.08	1.74
Cost (\$)	236.78	375.90	153.69	41.30	807.67
Purchase Price (\$)	136.81	269.69	28.26	2.36	437.12
16,000# Production, Mixed Mainly Legume Forage 50/50 Ration (30 Percent bGH Response)					
Corn Silage (tons)	2.08	1.97	2.62	0.81	7.48
Corn Grain (bu)	16.10	44.51	0.56	0.00	61.17
Mixed Mainly Legume (tons)	0.79	0.75	1.00	0.31	2.84
Soy-44 (cwt)	4.34	9.33	1.85	0.00	15.52
Premix (cwt)	0.50	1.02	0.30	0.08	1.89
Cost (\$)	236.78	419.05	166.20	41.30	863.33
Purchase Price (\$)	136.81	324.06	39.76	2.36	502.99

Appendix Z Cont.

Ration Ingredients and Costs	Production Period				
	Early	Mid	Late	Dry	Total
16,000# Production, Mixed Mainly Legume Forage 50/50 Ration (40 Percent bGH Response)					
Corn Silage (tons)	2.08	1.80	2.52	0.81	7.21
Corn Grain (bu)	16.10	46.59	4.38	0.00	67.07
Mixed Mainly Legume (tons)	0.79	0.68	0.95	0.31	2.73
Soy-44 (cwt)	4.34	9.03	2.50	0.00	15.87
Premix (cwt)	0.50	1.17	0.31	0.08	2.06
Cottonseed (cwt)	0.00	3.06	0.00	0.00	3.06
Cost (\$)	236.78	476.32	185.43	41.30	939.83
Purchase Price (\$)	136.81	389.54	64.26	2.36	592.97
16,000# Production, Mixed Mainly Legume Forage 75/25 Ration (no bGH)					
Corn Silage (tons)	3.30	4.47	3.67	1.37	12.81
Corn Grain (bu)	9.95	9.17	0.00	0.00	19.13
Mixed Mainly Legume (tons)	0.42	0.56	0.46	0.17	1.62
Soy-44 (cwt)	5.74	7.01	1.97	0.00	14.72
Premix (cwt)	0.65	0.79	0.41	0.11	1.95
Cost (\$)	240.92	297.49	152.18	44.84	735.43
Purchase Price (\$)	139.49	160.27	39.47	2.36	341.59
16,000# Production, Mixed Mainly Legume Forage 75/25 Ration (10 Percent bGH Response)					
Corn Silage (tons)	3.30	4.03	3.65	1.37	12.35
Corn Grain (bu)	9.95	18.66	0.00	0.00	28.61
Mixed Mainly Legume (tons)	0.42	0.51	0.46	0.17	1.56
Soy-44 (cwt)	5.74	8.17	2.50	0.00	16.41
Premix (cwt)	0.65	0.91	0.43	0.11	2.09
Cost (\$)	240.92	337.43	160.62	44.84	783.81
Purchase Price (\$)	139.49	213.60	48.56	2.36	404.01
16,000# Production, Mixed Mainly Legume Forage 75/25 Ration (20 Percent bGH Response)					
Corn Silage (tons)	3.30	3.49	3.71	1.37	11.86
Corn Grain (bu)	9.95	29.61	0.00	0.00	39.56
Mixed Mainly Legume (tons)	0.42	0.44	0.47	0.17	1.50
Soy-44 (cwt)	5.74	9.45	3.07	0.00	18.26
Premix (cwt)	0.65	1.03	0.46	0.11	2.24
Cost (\$)	240.92	380.93	172.35	44.84	839.04
Purchase Price (\$)	139.49	273.81	58.51	2.36	474.17

Appendix Z Cont.

Ration Ingredients and Costs	Production Period				
	Early	Mid	Late	Dry	Total
16,000# Production, Mixed Mainly Legume Forage 75/25 Ration (30 Percent bGH Response)					
Corn Silage (tons)	3.30	3.11	3.76	1.37	11.55
Corn Grain (bu)	9.95	39.14	0.00	0.00	49.09
Mixed Mainly Legume (tons)	0.42	0.39	0.48	0.17	1.46
Soy-44 (cwt)	5.74	10.66	3.64	0.00	20.04
Premix (cwt)	0.65	1.14	0.49	0.11	2.38
Cost (\$)	240.92	423.88	184.07	44.84	893.71
Purchase Price (\$)	139.49	328.25	68.45	2.36	538.55
16,000# Production, Mixed Mainly Legume Forage 75/25 Ration (40 Percent bGH Response)					
Corn Silage (tons)	3.30	2.87	3.82	1.37	11.36
Corn Grain (bu)	9.95	40.56	0.00	0.00	50.51
Mixed Mainly Legume (tons)	0.42	0.36	0.48	0.17	1.43
Soy-44 (cwt)	5.74	9.96	4.21	0.00	19.91
Premix (cwt)	0.65	1.32	0.52	0.11	2.60
Cottonseed (cwt)	3.67	0.00	0.00	0.00	0.00
Cost (\$)	240.92	485.19	195.79	44.84	966.74
Purchase Price (\$)	139.49	397.10	78.40	2.36	617.35
16,000# Production, Mixed Mainly Grass Forage All Hay Ration (No bGH)					
Corn Silage (tons)	0.00	0.00	0.00	0.00	0.00
Corn Grain (bu)	30.43	36.94	9.88	0.00	77.25
Mixed Mainly Grass (tons)	1.13	1.53	1.64	0.71	5.01
Soy-44 (cwt)	4.54	5.38	0.16	0.00	10.07
Premix (cwt)	0.68	0.84	0.47	0.15	2.14
Cost (\$)	261.58	325.56	146.81	46.61	780.56
Purchase Price (\$)	191.50	230.86	44.89	2.95	470.20
16,000# Production, Mixed Mainly Grass Forage All Hay Ration (10 Percent bGH Response)					
Corn Silage (tons)	0.00	0.00	0.00	0.00	0.00
Corn Grain (bu)	30.43	43.55	12.57	0.00	86.55
Mixed Mainly Grass (tons)	1.13	1.38	1.55	0.71	4.77
Soy-44 (cwt)	4.54	6.70	0.78	0.00	12.02
Premix (cwt)	0.68	0.95	0.46	0.15	2.23
Cost (\$)	261.58	362.40	161.20	46.61	831.75
Purchase Price (\$)	191.50	276.64	64.85	2.95	535.94

Appendix Z Cont.

Ration Ingredients and Costs	Production Period				
	Early	Mid	Late	Dry	Total
16,000# Production, Mixed Mainly Grass Forage All Hay Ration (20 Percent bGH Response)					
Corn Silage (tons)	0.00	0.00	0.00	0.00	0.00
Corn Grain (bu)	30.43	50.98	15.56	0.00	96.97
Mixed Mainly Grass (tons)	1.13	1.20	1.50	0.71	4.53
Soy-44 (cwt)	4.54	8.17	1.43	0.00	14.13
Premix (cwt)	0.68	1.07	0.47	0.15	2.36
Cost (\$)	261.58	402.17	179.07	46.61	889.43
Purchase Price (\$)	191.50	327.67	86.34	2.95	608.46
16,000# Production, Mixed Mainly Grass Forage All Hay Ration (30 Percent bGH Response)					
Corn Silage (tons)	0.00	0.00	0.00	0.00	0.00
Corn Grain (bu)	30.43	54.17	18.64	0.00	103.24
Mixed Mainly Grass (tons)	1.13	1.11	1.43	0.71	4.38
Soy-44 (cwt)	4.54	8.47	2.08	0.00	15.09
Premix (cwt)	0.68	1.19	0.50	0.15	2.52
Cottonseed (cwt)	0.00	1.90	0.00	0.00	1.90
Cost (\$)	261.58	452.23	197.26	46.61	957.68
Purchase Price (\$)	191.50	338.38	108.40	2.95	641.23
16,000# Production, Mixed Mainly Grass Forage All Hay Ration (40 Percent bGH Response)					
Corn Silage (tons)	0.00	0.00	0.00	0.00	0.00
Corn Grain (bu)	30.43	54.82	21.77	0.00	107.02
Mixed Mainly Grass (tons)	1.13	1.03	1.37	0.71	4.24
Soy-44 (cwt)	4.54	8.04	2.73	0.00	15.31
Premix (cwt)	0.68	1.37	0.53	0.15	2.73
Cottonseed (cwt)	0.00	5.36	0.00	0.00	5.36
Cost (\$)	261.58	513.97	215.57	46.61	1,037.73
Purchase Price (\$)	191.50	449.82	130.67	2.95	774.94
16,000# Production, Mixed Mainly Grass Forage 50/50 Ration (No bGH)					
Corn Silage (tons)	1.83	2.48	2.50	0.89	7.70
Corn Grain (bu)	19.71	22.38	0.00	0.00	42.09
Mixed Mainly Grass (tons)	0.69	0.93	0.94	0.33	2.89
Soy-44 (cwt)	5.63	6.85	1.16	0.00	13.64
Premix (cwt)	0.73	0.91	0.46	0.14	2.23
Cost (\$)	255.35	317.03	139.73	43.07	755.18
Purchase Price (\$)	172.36	204.79	26.73	2.95	406.83

Appendix Z Cont.

Ration Ingredients and Costs	Production Period				
	Early	Mid	Late	Dry	Total
16,000# Production, Mixed Mainly Grass Forage 50/50 Ration (10 Percent bGH Response)					
Corn Silage (tons)	1.83	2.24	2.44	0.89	7.41
Corn Grain (bu)	19.71	30.54	0.00	0.00	50.25
Mixed Mainly Grass (tons)	0.69	0.84	0.92	0.33	2.78
Soy-44 (cwt)	5.63	8.08	2.29	0.00	16.00
Premix (cwt)	0.73	1.01	0.50	0.14	2.38
Cost (\$)	255.35	355.00	156.53	43.07	809.95
Purchase Price (\$)	172.36	253.64	46.11	2.95	475.06
16,000# Production, Mixed Mainly Grass Forage 50/50 Ration (20 Percent bGH Response)					
Corn Silage (tons)	1.83	1.94	2.46	0.89	7.12
Corn Grain (bu)	19.71	39.85	0.61	0.00	60.16
Mixed Mainly Grass (tons)	0.69	0.73	0.92	0.33	2.67
Soy-44 (cwt)	5.63	9.33	2.85	0.00	17.80
Premix (cwt)	0.73	1.12	0.49	0.14	2.48
Cost (\$)	255.35	396.05	169.55	43.07	864.02
Purchase Price (\$)	172.36	303.31	58.22	2.95	536.84
16,000# Production, Mixed Mainly Grass Forage 50/50 Ration (30 Percent bGH Response)					
Corn Silage (tons)	1.83	1.77	2.35	0.89	6.84
Corn Grain (bu)	19.71	45.01	4.54	0.00	69.26
Mixed Mainly Grass (tons)	0.69	0.66	0.88	0.33	2.56
Soy-44 (cwt)	5.63	9.78	3.45	0.00	18.86
Premix (cwt)	0.73	1.24	0.55	0.14	2.66
Cottonseed (cwt)	0.00	1.40	0.00	0.00	1.40
Cost (\$)	255.35	443.35	188.42	43.07	930.19
Purchase Price (\$)	172.36	363.32	82.25	2.95	620.88
16,000# Production, Mixed Mainly Grass Forage 50/50 Ration (40 Percent bGH Response)					
Corn Silage (tons)	1.83	1.64	2.23	0.89	6.59
Corn Grain (bu)	19.71	46.31	8.53	0.00	74.55
Mixed Mainly Grass (tons)	0.69	0.62	0.84	0.33	2.15
Soy-44 (cwt)	5.63	9.24	4.06	0.00	18.93
Premix (cwt)	0.73	1.42	0.60	0.14	2.89
Cottonseed (cwt)	0.00	4.96	0.00	0.00	4.96
Cost (\$)	255.35	506.35	207.39	43.07	1,012.16
Purchase Price (\$)	172.36	431.97	106.49	2.95	713.77

Appendix Z Cont.

Ration Ingredients and Costs	Production Period				
	Early	Mid	Late	Dry	Total
16,000# Production, Mixed Mainly Grass Forage 75/25 Ration (no bGH)					
Corn Silage (tons)	3.09	4.18	3.58	1.48	12.32
Corn Grain (bu)	12.38	12.43	0.00	0.00	24.81
Mixed Mainly Grass (tons)	0.39	0.52	0.45	0.18	1.54
Soy-44 (cwt)	6.37	7.86	2.69	0.00	16.92
Premix (cwt)	0.77	0.96	0.55	6.61	8.89
Cost (\$)	251.10	311.20	158.87	46.61	767.78
Purchase Price (\$)	159.30	186.97	52.42	2.95	401.64
16,000# Production, Mixed Mainly Grass Forage 75/25 Ration (10 Percent bGH Response)					
Corn Silage (tons)	3.09	3.76	3.56	1.48	11.88
Corn Grain (bu)	12.38	21.69	0.00	0.00	34.07
Mixed Mainly Grass (tons)	0.39	0.47	0.44	0.18	1.49
Soy-44 (cwt)	6.37	8.94	3.22	0.00	18.53
Premix (cwt)	0.77	1.06	0.57	6.61	9.01
Cost (\$)	251.10	349.96	167.23	46.61	814.90
Purchase Price (\$)	159.30	238.00	61.44	2.95	461.69
16,000# Production, Mixed Mainly Grass Forage 75/25 Ration (20 Percent bGH Response)					
Corn Silage (tons)	3.09	3.25	3.61	1.48	11.43
Corn Grain (bu)	12.38	32.32	0.00	0.00	44.70
Mixed Mainly Grass (tons)	0.39	0.41	0.45	0.18	1.43
Soy-44 (cwt)	6.37	10.11	3.80	0.00	20.28
Premix (cwt)	0.77	1.16	0.61	6.61	9.14
Cost (\$)	251.10	391.92	179.11	46.61	868.74
Purchase Price (\$)	159.30	295.22	71.59	2.95	529.06
16,000# Production, Mixed Mainly Grass Forage 75/25 Ration (30 Percent bGH Response)					
Corn Silage (tons)	3.09	2.94	3.67	1.48	11.18
Corn Grain (bu)	12.38	38.95	0.00	0.00	51.33
Mixed Mainly Grass (tons)	0.39	0.37	0.46	0.18	1.40
Soy-44 (cwt)	6.37	10.65	4.38	0.00	21.40
Premix (cwt)	0.77	1.26	0.64	6.61	9.28
Cottonseed (cwt)	0.00	1.07	0.00	0.00	1.07
Cost (\$)	251.10	437.47	190.94	46.61	926.12
Purchase Price (\$)	159.30	350.04	81.74	2.95	594.03

Appendix Z Cont.

Ration Ingredients and Costs	Production Period				
	Early	Mid	Late	Dry	Total
16,000# Production, Mixed Mainly Grass Forage 75/25 Ration (40 Percent bGH Response)					
Corn Silage (tons)	3.09	2.73	3.73	1.48	11.03
Corn Grain (bu)	12.38	40.69	0.00	0.00	53.07
Mixed Mainly Grass (tons)	0.39	0.34	0.47	0.18	1.38
Soy-44 (cwt)	6.36	10.02	4.96	0.00	21.35
Premix (cwt)	0.77	1.45	0.68	6.61	9.51
Cottonseed (cwt)	0.00	4.69	0.00	0.00	4.69
Cost (\$)	251.10	501.40	202.77	46.61	1,001.88
Purchase Price (\$)	159.30	420.20	91.89	2.95	674.34

Appendix AA

FEED RATIONS AND COSTS PER COW BY PRODUCTION PERIOD, HAY TYPE,
ANNUAL MILK PRODUCTION, bGH RESPONSE AND FORAGE COMPOSITION
WITH ENHANCED INTAKE

Ration Ingredients and Costs	Production Period				
	Early	Mid	Late	Dry	Total
16,000# Production, Mixed Mainly Legume Forage All Hay Ration (10 Percent bGH Response)					
Corn Silage (tons)	0.00	0.00	0.00	0.00	0.00
Corn Grain (bu)	26.64	35.66	7.35	0.00	69.65
Mixed Mainly Legume (tons)	1.40	1.87	2.10	0.68	6.05
Soy-44 (cwt)	2.02	2.70	0.00	0.00	4.72
Premix (cwt)	0.31	0.42	0.29	0.10	1.12
Cost (\$)	230.75	308.91	176.43	50.15	766.24
Purchase Price (\$)	133.92	179.28	31.46	2.95	347.61
16,000# Production, Mixed Mainly Legume Forage All Hay Ration (20 Percent bGH Response)					
Corn Silage (tons)	0.00	0.00	0.00	0.00	0.00
Corn Grain (bu)	26.64	37.93	11.91	0.00	76.48
Mixed Mainly Legume (tons)	1.40	1.99	2.05	0.68	6.12
Soy-44 (cwt)	2.02	2.88	0.00	0.00	4.90
Premix (cwt)	0.31	0.44	0.30	0.10	1.16
Cost (\$)	230.75	328.54	189.78	50.15	799.22
Purchase Price (\$)	133.92	190.68	48.02	2.95	375.57
16,000# Production, Mixed Mainly Legume Forage All Hay Ration (30 Percent bGH Response)					
Corn Silage (tons)	0.00	0.00	0.00	0.00	0.00
Corn Grain (bu)	26.64	40.16	16.58	0.00	83.38
Mixed Mainly Legume (tons)	1.40	2.11	2.00	0.68	6.19
Soy-44 (cwt)	2.02	3.04	0.00	0.00	5.06
Premix (cwt)	0.31	0.47	0.33	0.10	1.21
Cost (\$)	230.75	347.84	203.09	50.15	831.82
Purchase Price (\$)	133.92	201.87	64.92	2.95	403.67

Appendix AA Cont.

Ration Ingredients and Costs	Production Period				
	Early	Mid	Late	Dry	Total
16,000# Production, Mixed Mainly Legume Forage All Hay Ration (40 Percent bGH Response)					
Corn Silage (tons)	0.00	0.00	0.00	0.00	0.00
Corn Grain (bu)	26.64	42.35	21.35	0.00	90.34
Mixed Mainly Legume (tons)	1.40	2.23	1.95	0.68	6.26
Soy-44 (cwt)	2.02	3.21	0.00	0.00	5.23
Premix (cwt)	0.31	0.49	0.34	0.10	1.25
Cost (\$)	230.75	366.80	216.34	50.15	864.04
Purchase Price (\$)	133.92	212.88	82.15	2.95	431.90
16,000# Production, Mixed Mainly Legume Forage 50/50 Ration (10 Percent bGH Response)					
Corn Silage (tons)	2.08	2.78	2.98	0.81	8.66
Corn Grain (bu)	16.10	21.55	0.00	0.00	37.65
Mixed Mainly Legume (tons)	0.79	1.06	1.13	0.31	3.29
Soy-44 (cwt)	4.34	5.81	0.89	0.00	11.04
Premix (cwt)	0.50	0.67	0.34	0.08	1.59
Cost (\$)	236.78	316.99	165.78	41.30	760.85
Purchase Price (\$)	136.81	183.15	22.08	2.36	344.41
16,000# Production, Mixed Mainly Legume Forage 50/50 Ration (20 Percent bGH Response)					
Corn Silage (tons)	2.08	2.96	3.05	0.81	8.90
Corn Grain (bu)	16.10	22.92	0.00	0.00	39.02
Mixed Mainly Legume (tons)	0.79	1.12	1.16	0.31	3.39
Soy-44 (cwt)	4.34	6.18	1.51	0.00	12.03
Premix (cwt)	0.50	0.71	0.34	0.08	1.63
Cost (\$)	236.78	337.13	180.14	41.30	795.35
Purchase Price (\$)	136.81	194.79	33.12	2.36	367.08
16,000# Production, Mixed Mainly Legume Forage 50/50 Ration (30 Percent bGH Response)					
Corn Silage (tons)	2.08	3.14	3.06	0.81	9.11
Corn Grain (bu)	16.10	24.27	0.66	0.00	41.03
Mixed Mainly Legume (tons)	0.79	1.19	1.18	0.31	3.47
Soy-44 (cwt)	4.34	6.54	2.18	0.00	13.06
Premix (cwt)	0.50	0.76	0.35	0.08	1.69
Cost (\$)	236.78	356.93	195.73	41.30	830.73
Purchase Price (\$)	136.81	206.23	46.82	2.36	392.22

Appendix AA Cont.

Ration Ingredients and Costs	Production Period				
	Early	Mid	Late	Dry	Total
16,000# Production, Mixed Mainly Legume Forage 50/50 Ration (40 Percent bGH Response)					
Corn Silage (tons)	2.08	3.31	2.98	0.81	9.17
Corn Grain (bu)	16.10	25.59	5.18	0.00	46.87
Mixed Mainly Legume (tons)	0.79	1.26	1.12	0.31	3.48
Soy-44 (cwt)	4.34	6.90	2.95	0.00	14.19
Premix (cwt)	0.50	0.79	0.37	0.08	1.74
Cost (\$)	236.78	376.38	219.12	41.30	873.58
Purchase Price (\$)	136.81	217.47	75.94	2.36	432.58
16,000# Production, Mixed Mainly Legume Forage 75/25 Ration (10 Percent bGH Response)					
Corn Silage (tons)	3.30	4.42	4.25	1.37	13.34
Corn Grain (bu)	9.95	13.32	0.00	0.00	23.27
Mixed Mainly Legume (tons)	0.42	0.56	0.54	0.17	1.69
Soy-44 (cwt)	5.74	7.68	2.91	0.00	16.34
Premix (cwt)	0.65	0.87	0.50	0.11	2.13
Cost (\$)	240.92	322.53	187.08	44.84	795.38
Purchase Price (\$)	139.49	186.74	56.56	2.36	385.15
16,000# Production, Mixed Mainly Legume Forage 75/25 Ration (20 Percent bGH Response)					
Corn Silage (tons)	3.30	4.70	4.35	1.37	13.72
Corn Grain (bu)	9.95	14.17	0.00	0.00	24.12
Mixed Mainly Legume (tons)	0.42	0.60	0.55	0.17	1.74
Soy-44 (cwt)	5.74	8.17	3.60	0.00	17.51
Premix (cwt)	0.65	0.93	0.54	0.11	2.22
Cost (\$)	240.92	343.02	202.01	44.84	830.79
Purchase Price (\$)	139.49	198.61	68.58	2.36	409.04
16,000# Production, Mixed Mainly Legume Forage 75/25 Ration (30 Percent bGH Response)					
Corn Silage (tons)	3.30	4.97	4.43	1.37	14.07
Corn Grain (bu)	9.95	15.00	0.00	0.00	24.95
Mixed Mainly Legume (tons)	0.42	0.63	0.57	0.17	1.79
Soy-44 (cwt)	5.74	8.65	4.29	0.00	18.68
Premix (cwt)	0.65	0.98	0.58	0.11	2.31
Cost (\$)	240.92	363.17	216.77	44.84	865.70
Purchase Price (\$)	139.49	210.27	80.61	2.36	432.73

Appendix AA Cont.

Ration Ingredients and Costs	Production Period				
	Early	Mid	Late	Dry	Total
16,000# Production, Mixed Mainly Legume Forage 75/25 Ration (40 Percent bGH Response)					
Corn Silage (tons)	3.30	5.25	4.51	1.37	14.43
Corn Grain (bu)	9.95	15.82	0.00	0.00	25.77
Mixed Mainly Legume (tons)	0.42	0.67	0.57	0.17	1.82
Soy-44 (cwt)	5.74	9.12	4.97	0.00	19.84
Premix (cwt)	0.65	1.03	0.61	0.11	2.41
Cost (\$)	240.92	382.96	231.36	44.84	900.09
Purchase Price (\$)	139.49	221.73	92.64	2.36	456.23
16,000# Production, Mixed Mainly Grass Forage All Hay Ration (10 Percent bGH Response)					
Corn Silage (tons)	0.00	0.00	0.00	0.00	0.00
Corn Grain (bu)	30.43	40.74	14.64	0.00	85.81
Mixed Mainly Grass (tons)	1.13	1.51	1.81	0.71	5.16
Soy-44 (cwt)	4.54	6.08	0.91	0.00	11.53
Premix (cwt)	0.68	0.91	0.54	0.15	2.28
Cost (\$)	261.58	350.19	187.76	46.61	846.14
Purchase Price (\$)	191.50	256.37	75.53	2.95	526.35
16,000# Production, Mixed Mainly Legume Grass All Hay Ration (20 Percent bGH Response)					
Corn Silage (tons)	0.00	0.00	0.00	0.00	0.00
Corn Grain (bu)	30.43	43.33	18.24	0.00	91.99
Mixed Mainly Grass (tons)	1.13	1.61	1.76	0.71	5.21
Soy-44 (cwt)	4.54	6.46	1.68	0.00	12.68
Premix (cwt)	0.68	0.97	0.55	0.15	2.35
Cost (\$)	261.58	372.44	209.89	46.61	890.52
Purchase Price (\$)	191.50	272.66	101.20	2.95	568.31
16,000# Production, Mixed Mainly Grass Forage All Hay Ration (30 Percent bGH Response)					
Corn Silage (tons)	0.00	0.00	0.00	0.00	0.00
Corn Grain (bu)	30.43	45.87	21.95	0.00	98.25
Mixed Mainly Grass (tons)	1.13	1.70	1.68	0.71	5.23
Soy-44 (cwt)	4.54	6.84	2.45	0.00	13.83
Premix (cwt)	0.68	1.03	0.59	0.15	2.44
Cost (\$)	261.58	394.31	232.31	46.61	934.81
Purchase Price (\$)	191.50	288.67	127.66	2.95	610.78

Appendix AA Cont.

Ration Ingredients and Costs	Production Period				
	Early	Mid	Late	Dry	Total
16,000# Production, Mixed Mainly Grass Forage All Hay Ration (40 Percent bGH Response)					
Corn Silage (tons)	0.00	0.00	0.00	0.00	0.00
Corn Grain (bu)	30.43	48.37	25.73	0.00	104.53
Mixed Mainly Grass (tons)	1.13	1.80	1.62	0.71	5.26
Soy-44 (cwt)	4.54	7.22	3.23	0.00	14.98
Premix (cwt)	0.68	1.08	0.63	0.15	2.54
Cost (\$)	261.58	415.80	254.74	46.61	978.73
Purchase Price (\$)	191.50	304.41	154.41	2.95	653.27
16,000# Production, Mixed Mainly Grass Forage 50/50 Ration (10 Percent bGH Response)					
Corn Silage (tons)	1.83	2.45	2.84	0.89	8.01
Corn Grain (bu)	19.71	26.39	0.00	0.00	46.10
Mixed Mainly Grass (tons)	0.69	0.92	1.07	0.33	3.02
Soy-44 (cwt)	5.63	7.54	2.67	0.00	15.83
Premix (cwt)	0.73	0.98	0.58	0.14	2.43
Cost (\$)	255.35	341.85	182.32	43.07	822.59
Purchase Price (\$)	172.36	230.75	53.71	2.95	459.76
16,000# Production, Mixed Mainly Grass Forage 50/50 Ration (20 Percent bGH Response)					
Corn Silage (tons)	1.83	2.61	2.88	0.89	8.21
Corn Grain (bu)	19.71	28.06	0.71	0.00	48.49
Mixed Mainly Grass (tons)	0.69	0.98	1.08	0.33	3.08
Soy-44 (cwt)	5.63	8.02	3.34	0.00	16.99
Premix (cwt)	0.73	1.04	0.57	0.14	2.48
Cost (\$)	255.35	363.57	198.73	43.07	860.72
Purchase Price (\$)	172.36	245.41	68.24	2.95	488.96
16,000# Production, Mixed Mainly Grass Forage 50/50 Ration (30 Percent bGH Response)					
Corn Silage (tons)	1.83	2.76	2.77	0.89	8.25
Corn Grain (bu)	19.71	29.71	5.37	0.00	54.77
Mixed Mainly Grass (tons)	0.69	1.04	1.04	0.33	3.10
Soy-44 (cwt)	5.63	8.49	4.06	0.00	18.18
Premix (cwt)	0.73	1.10	0.65	0.14	2.62
Cost (\$)	255.35	384.92	221.90	43.07	905.23
Purchase Price (\$)	172.36	259.82	96.86	2.95	531.99

Appendix AA Cont.

Ration Ingredients and Costs	Production Period				
	Early	Mid	Late	Dry	Total
16,000# Production, Mixed Mainly Grass Forage 50/50 Ration (40 Percent bGH Response)					
Corn Silage (tons)	1.83	2.91	2.64	0.89	8.26
Corn Grain (bu)	19.71	31.33	10.08	0.00	61.12
Mixed Mainly Grass (tons)	0.69	1.10	0.99	0.33	3.11
Soy-44 (cwt)	5.63	8.95	4.80	0.00	19.38
Premix (cwt)	0.73	1.16	0.71	0.14	2.74
Cost (\$)	255.35	405.90	245.07	43.07	949.39
Purchase Price (\$)	172.36	273.98	125.84	2.95	575.13
16,000# Production, Mixed Mainly Grass Forage 75/25 Ration (10 Percent bGH Response)					
Corn Silage (tons)	3.09	4.14	4.15	1.48	12.85
Corn Grain (bu)	12.38	16.57	0.00	0.00	28.95
Mixed Mainly Grass (tons)	0.39	0.52	0.51	0.18	1.60
Soy-44 (cwt)	6.37	8.53	3.75	0.00	18.65
Premix (cwt)	0.77	1.03	0.66	6.61	9.07
Cost (\$)	251.10	336.16	194.78	46.61	828.65
Purchase Price (\$)	159.30	213.26	71.56	2.95	447.07
16,000# Production, Mixed Mainly Grass Forage 75/25 Ration (20 Percent bGH Response)					
Corn Silage (tons)	3.09	4.40	4.23	1.48	13.20
Corn Grain (bu)	12.38	17.63	0.00	0.00	30.01
Mixed Mainly Grass (tons)	0.39	0.56	0.53	0.18	1.65
Soy-44 (cwt)	6.37	9.07	4.45	0.00	19.89
Premix (cwt)	0.77	1.10	0.71	6.61	9.19
Cost (\$)	251.10	357.52	209.94	46.61	865.16
Purchase Price (\$)	159.30	226.81	83.91	2.95	472.97
16,000# Production, Mixed Mainly Grass Forage 75/25 Ration (30 Percent bGH Response)					
Corn Silage (tons)	3.09	4.66	4.32	1.48	13.55
Corn Grain (bu)	12.38	18.66	0.00	0.00	31.04
Mixed Mainly Grass (tons)	0.39	0.59	0.54	0.18	1.70
Soy-44 (cwt)	6.37	9.60	5.16	0.00	21.13
Premix (cwt)	0.77	1.16	0.75	6.61	9.29
Cost (\$)	251.10	378.51	224.86	46.61	901.09
Purchase Price (\$)	159.30	240.13	96.26	2.95	498.64

Appendix AA Cont.

Ration Ingredients and Costs	Production Period				
	Early	Mid	Late	Dry	Total
16,000# Production, Mixed Mainly Grass Forage 75/25 Ration (40 Percent bGH Response)					
Corn Silage (tons)	3.09	4.91	4.41	1.48	13.89
Corn Grain (bu)	12.38	19.68	0.00	0.00	32.06
Mixed Mainly Grass (tons)	0.39	0.62	0.56	0.18	1.75
Soy-44 (cwt)	6.37	10.13	5.86	0.00	22.36
Premix (cwt)	0.77	1.22	0.80	6.61	9.41
Cost (\$)	251.10	399.15	239.61	46.61	936.47
Purchase Price (\$)	159.30	253.22	108.59	2.95	524.06

AB-1

Appendix AB

INFORMATION ON bGH PROVIDED TO RESPONDENTS AND
QUESTIONNAIRE

[FICTIONAL ADVERTISEMENT IN HOARD'S DAIRYMAN]

What would you pay to increase your herd average potential from 14,000 to 15,750 or from 16,000 to 18,000 pounds?

Now from CORBIO^(R) for only 17¢ (plus feed) a day you can do just that.

How does it work?

Without CORBIO^(R), production declines steadily during the latter period of the lactation cycle.

With CORBIO^(R), production is 10 to 40 percent higher over that period than in the untreated cow.*

Yet CORBIO is a complete, safe, naturally occurring compound that is already present in your lactating animals. You are simply adding more to stimulate increased production. And the increase starts only a few days after treatment is begun in the 13th week of lactation.

For further information see your dealer.

* Must be injected daily. CORBIO is a registered trademark.

Production responses based on data from experiments at Cornell and other universities.

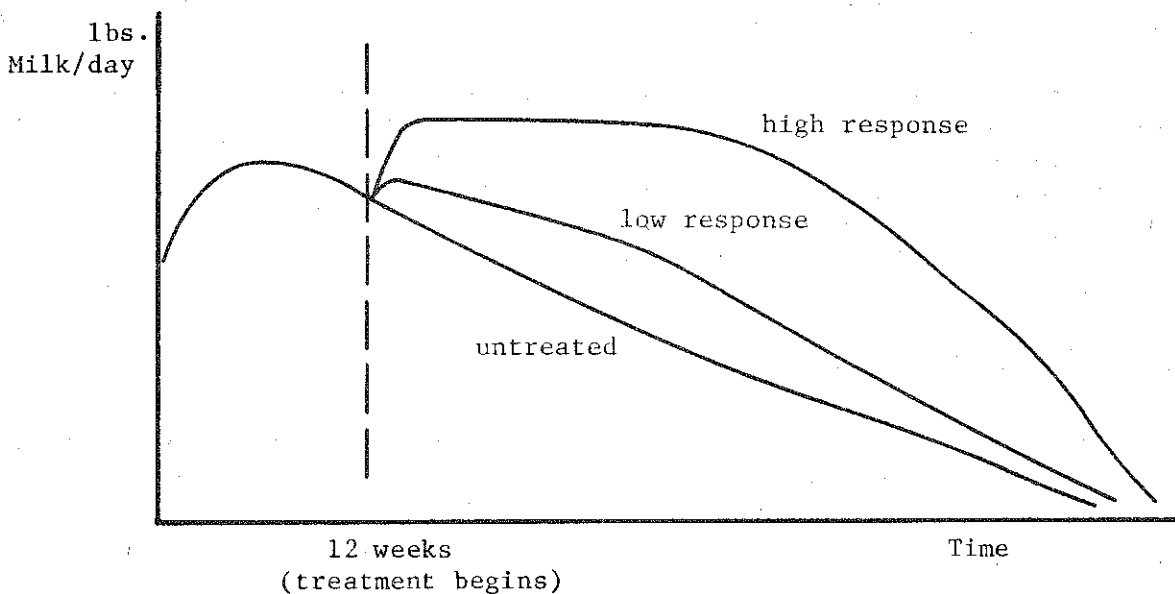

CORBIO^(R) breaks the production ceiling every time!

[FICTIONAL COOPERATIVE EXTENSION FACT SHEET]

Cooperative Extension Service of _____

GROWTH HORMONES

The recent advertisements for CORBIO^(R) and other growth hormones for dairy cattle have raised considerable interest among dairymen. This Fact Sheet is a quick summary of the available information on this new product.

What is it?

Growth hormones are naturally occurring compounds which regulate the functions of animals. It has long been known that these hormones increase milk output, but only with recent developments in biotechnology has it been possible to produce them cheaply and in large quantities.

Is it safe for humans?

Yes. Hormones are a form of protein. Protein is not accumulated in the body as it is broken down rapidly into amino acids. In fact, hormones must be injected into the cow to be effective because if consumed orally they are digested like any other dietary protein.

Is it safe for my herd?

Based on all experimental evidence the answer is yes. Experimental animals demonstrate normal reproduction and normal mammary health with no impairment to disease resistance. These results have been filed with and accepted by the Food and Drug Administration as a proof of safety. Information on the long term effects over multiple lactation cycles nevertheless is incomplete at this time.

Several related points should be emphasized as they are of obvious concern to any potential user. Careful examinations of the udder have shown no ill effects even at the highest levels of milk production made possible by the compound. In most cases the cow is bred during the first 13 weeks of the lactation cycle when use of the compound is not needed. However should breeding not be successful during that period, test cows have shown no unusual problems in conceiving while on treatment. Fetal growth is unaffected.

Suppose I miss a day or accidentally double the dosage?

Either of these occurrences should cause no real problems. Missing a dose will cause a cow to drop to the untreated level of production within 24 hours. Restarting the injections will however restore her to the original level within a few days. Doubling dosages wastes money as the additional yield response is small. But no harm is done to the cow.

FICTIONAL

How does it work?

This compound coordinates body tissues to allow greater milk production. In this respect it acts similarly to differences seen in genetically superior cows.

How is it administered?

Growth hormones must be administered daily into the body. It is usually done with a hypodermic needle, but an injection "gun" is acceptable. The dosage is small - on the order of one cc.

What does it do for milk production?

Results from experiments at Cornell and other universities show test herd average production increases of 10 to 40 percent during treatment but after the first 12 weeks of lactation. Output increases almost immediately, and benefits over regular milk production levels persist throughout the remaining portion of the lactation cycle. Differences in response are due largely to amounts of hormone used (up to the maximum recommended dose). However, feeding practices and variation among individual cows will also influence results. Heavy producers respond at least as well as average or poorer producing cows.

Dosage begins following the peak of lactation, during the 13th week of the cycle. Butter fat and protein levels of the milk are unchanged.

How will my feed requirements change?

After beginning treatment, the cow will increase feed intake to levels needed to meet requirements. Thereafter, cows should be fed according to milk production as per typical management recommendations. There is no evidence that more exotic (and expensive) feed ingredients need to be used. However, the higher the level of milk production the more important is proper nutritional management to allow the cow to reach her potential. That is the treated cow with a higher milk production should not be shifted to a lower energy diet as rapidly as would the untreated cow.

Is it profitable?

Table 1 gives a quick indication of the possible returns to treatment, excluding the cost of the treatment. These figures suggest that the use of this product can be quite profitable at the higher yield increase levels. Most of the benefits come from the increase in economic efficiency in milk production where maintenance requirements are constant and incremental feed is converted into additional milk production. Since maintenance requirements consume 30-35 percent of the feed, benefits are clearly quite large.

The information in Table 1 applies to high producing (21,500 lbs.) cows in an experimental herd with no first calf heifers. Results must be scaled back to represent the typical commercial herd.

Table 1

GROSS DAILY RETURNS PER COW FROM USE OF THE COMPOUND

- Derived From Experimental Results Using 20,000+ lbs. Second Lactation Cows -

Item	Untreated	Treated Percent Increase in Milk Output		
		10% (6 lbs.)	20% (12 lbs.)	30% (18 lbs.)
Feed cost	\$3.37	+ \$.24	+ \$.48	+ \$.72
Milk value	\$6.72	+ .67	+ 1.34	+ 2.01
Gross return to compound use		+ .43	+ .86	+ 1.29

Based on milk at \$11/cwt.

Feed at ration prices of 8 cents/pound dry matter.

Source: Computed from experimental results. Gross return is prior to purchase of the hormone.

Compound use is especially attractive as no capital investment is needed and benefits are observed almost immediately. However, for your farm only you can determine the actual profitability by considering your own yield data, feed costs, and milk price figures.

When you calculate profitability it is important to remember that (a) production during the first 12 weeks of lactation is unaffected, and (b) first-calf heifers comprise about 20 percent of any commercial herd and hold down the herd average.

What else should I consider?

While the results to date are all very positive, it is important to remember that no long-term commercial herd applications have been tried.

As you consider using this new product on your farm, pause to recognize the management impacts it will have on (a) the need to administer the compound daily to cows later in their lactation cycle, and (b) feed requirements of treated cows.

Address questions and comments to:

Dr. William Lesser
Dept. of Agricultural Economics
309 Warren Hall
Cornell University
Ithaca, NY 14853

PRODUCER QUESTIONNAIRE

The attached material describes a hypothetical product which could be available on the market within a few years. Please read this material before answering the questionnaire. When the product is eventually sold, little additional information is likely to be available.

1. County _____

2. How feasible does this product look for your dairy operation for the immediate future if it were available today?

- _____ very
- _____ somewhat
- _____ possible
- _____ questionable
- _____ other

Comments: _____

3. When do you think you would try it?

- _____ Immediately upon availability
- _____ 3 months after availability
- _____ 6 months after availability
- _____ 1 year after availability
- _____ 2 years after availability
- _____ 3 years after availability
- _____ 5 years after availability
- _____ longer
- _____ never

4. If you did adopt, would you likely begin slowly with a few cows or with the entire herd?

- _____ few head at first
- _____ entire herd

If you selected the first option, how would you select the trial cows?

5. If you need further information before trying the product, what information must you have? (check as many as apply).

- more experimental results
- a longer period of experimental results
- more specific information on feeding systems using the substance
- visit a herd on hormones
- recommendation of your vet
- wait for a neighbor to try it first and see how it works out for him
- other

Comments: _____

6. What are your current plans for changes in your milking herd size?

One year from now +/- _____

Five years from now +/- _____

7. What additional adjustments would you expect to make in your milking herd numbers following the introduction of the hormone if it were available today? (Answer should be zero if you do not intend to adopt within the specified time period.)

One year after beginning treatment +/- _____

Five years after beginning treatment +/- _____

Comments: _____

8. If you adopt the hormone while holding your herd size constant or increase it, your feed requirements will rise. How will you supply the additional feed requirements for forage and concentrate?

9. What additional expenditures do you feel would be necessary during the first year of adopting the hormone?

a) on feed production _____

b) on milking equipment _____

c) on buildings _____

d) on labor (annual) _____

e) on feed _____

f) on other _____

10. A possible market price for the hormone is 17¢ per cow per day. What difference would it make to your adoption decision and future plans if the daily dosage cost per cow was:

a) 10¢ _____

b) 25¢ _____

11. Preliminary work is underway on an implant which will release the compound in the proper daily dosage. Would having the implant available change your adoption decision? Please comment.

12. Overall, how many cows in your herd would you expect to be using the hormone in:

Injection	With Implant
_____ 6 months	_____ 6 months
_____ 1 year	_____ 1 year
_____ 2 years	_____ 2 years
_____ 3 years	_____ 3 years
_____ 5 years	_____ 5 years
_____ 10 years	_____ 10 years

13. Farm characteristics:

a) Average milking herd size for the second half of 1983: _____

b) Milking system: carry buckets _____
 (check one) pumping station _____
 pipeline _____
 herringbone parlor _____
 other parlor _____

c) Type of barn: stanchion _____
 (check one) free stall _____
 other _____

d) Average herd production for the first half of 1984: _____ lbs.

e) Do you presently use artificial insemination? Y/N _____

f) When did you begin artificially inseminating your herd? _____

g) Age of owner _____

14. Have you had any other experience with growth hormones? _____ If so, please describe your experience, if possible give name of product.

15. Are there any other factors relating to the adoption decision which you have not yet expressed? You may wish to comment on other considerations or mention factors you find to be troubling or unclear.

Name: _____

Address: _____

Phone number: _____

Date: _____

Please return in the enclosed postage paid envelope.

Please address any questions and comments to:

Dr. William Lesser
Dept. of Agricultural Economics
309 Warren Hall
Cornell University
Ithaca, NY 14853
(607) 256-4595

APPENDIX AC

PROJECTIONS OF bGH USE OVER TIME
(percent dairy herd/sample averages)

Data Treatment	Injections						Sample Size		
	Time Period								
	6 mo	1 yr	2 yr	3 yr	5 yr	10 yr			
All Respondents	23.7	43.2	48.5	53.1	53.2	55.5	119		
Complete Responses	31.5	51.4	58.2	65.9	65.4	67.2	54		
Complete Responses Excluding Partial Adopters	34.4	57.3	68.9	84.2	83.7	84.6	35		
	Implants								
	All Respondents	31.3	48.0	54.7	59.8	61.4		63.8	85
	Complete Responses	44.1	60.9	65.7	70.9	72.3		75.5	41
	Complete Responses Excluding Partial Adopters	43.1	64.0	71.9	86.9	88.8		90.0	26

Source: Sample results