

DRAINAGE RESEARCH MINER INSTITUTE -1978

SOIL and CROP RESPONSES

F. N. Swader
L. A. White, Jr.
L. D. Geohring

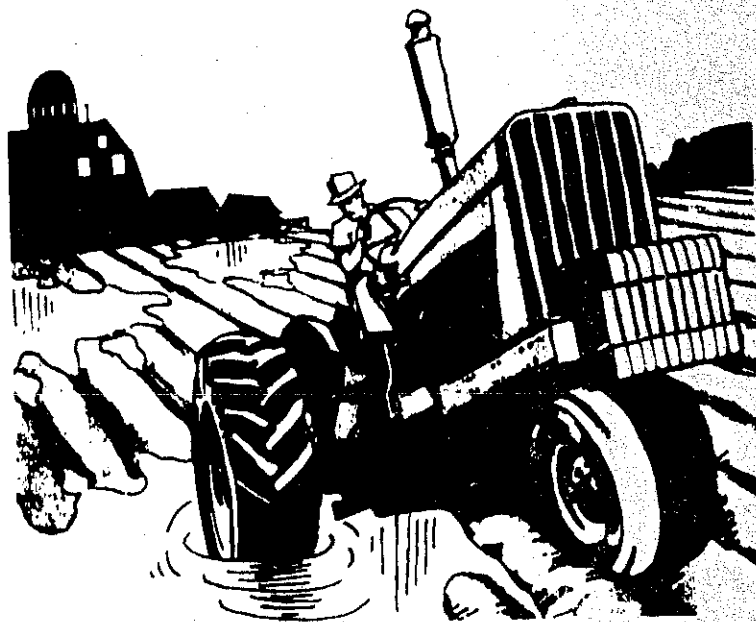

Agronomy Mimeo 80-36
AE Res 80-32
Ag. Engr. Staff
Report 80-05

September 1980

A multidisciplinary project of the New York State College of
Agriculture and Life Sciences

ACKNOWLEDGEMENTS

This publication is a report of the multidisciplinary research project, Soil and Water Management for Increased Crop Production in Northern New York (Hatch 498). This is a cooperative project involving the Departments of Agricultural Engineering, Agricultural Economics, and Agronomy at the College of Agriculture and Life Sciences. The respective cooperators are R. D. Black and L. D. Geohring, R. A. Milligan, and F. N. Swader and L. A. White, Jr. The field data were collected by personnel of the Cornell-Miner Project, under the on-site supervision of Mr. David H. Wilson.

This is the second report on the research into soil and water management for increased crop production in Northern New York. A previous report for 1977 was published as Agronomy Mimeo 78-21.

Hatch 498

Drainage Research - Miner Institute - 1978

CROP MANAGEMENT AND YIELDS

F. N. Swader and L.A. White, Jr.

This report covers the second year of a project (Soil and Water Management for Increased Crop Production in Northern New York, Hatch 498) designed to reflect the effects of improved drainage on crop yields. The project is comprised of fields 3I-1, 3I-2, and a field at Lake Alice. The general locations are shown in Fig. 1.

The Lake Alice site is managed as a control treatment both with respect to intensive cropping (and drainage improvement) and with respect to an optimum cropping system (without drainage improvement). The yield subplots and soils are shown in Fig. 2.

The west half of the area constitutes the control for the drainage treatments, and is cropped (as much as possible) like fields 3I-1 and 3I-2. It should have been planted to corn in 1978, but it was not because it remained too wet to plant until too late in the season. Sudangrass was planted as a substitute at the discretion of the farm manager, and as a common substitute or emergency crop.

The east half is considered as a control for a traditional (non-intensive, non-drained) situation. The area is currently being managed and harvested as a "native meadow" with a wide variety of grass and sedge species present. It has had no tillage operations for at least 15 years. The grass is harvested as hay, and only the gross yields have been recorded (there have been no yield subplots established).

Field 3I-1 is a comparison of sub-surface drainage systems with two drain spacings (50 and 100 feet) in 4 distinct soil types. The field plan and plot locations are shown in Figures 3 and 4-7.

Field 3I-2 is a comparison of surface drainage treatments, as indicated in Fig. 8.

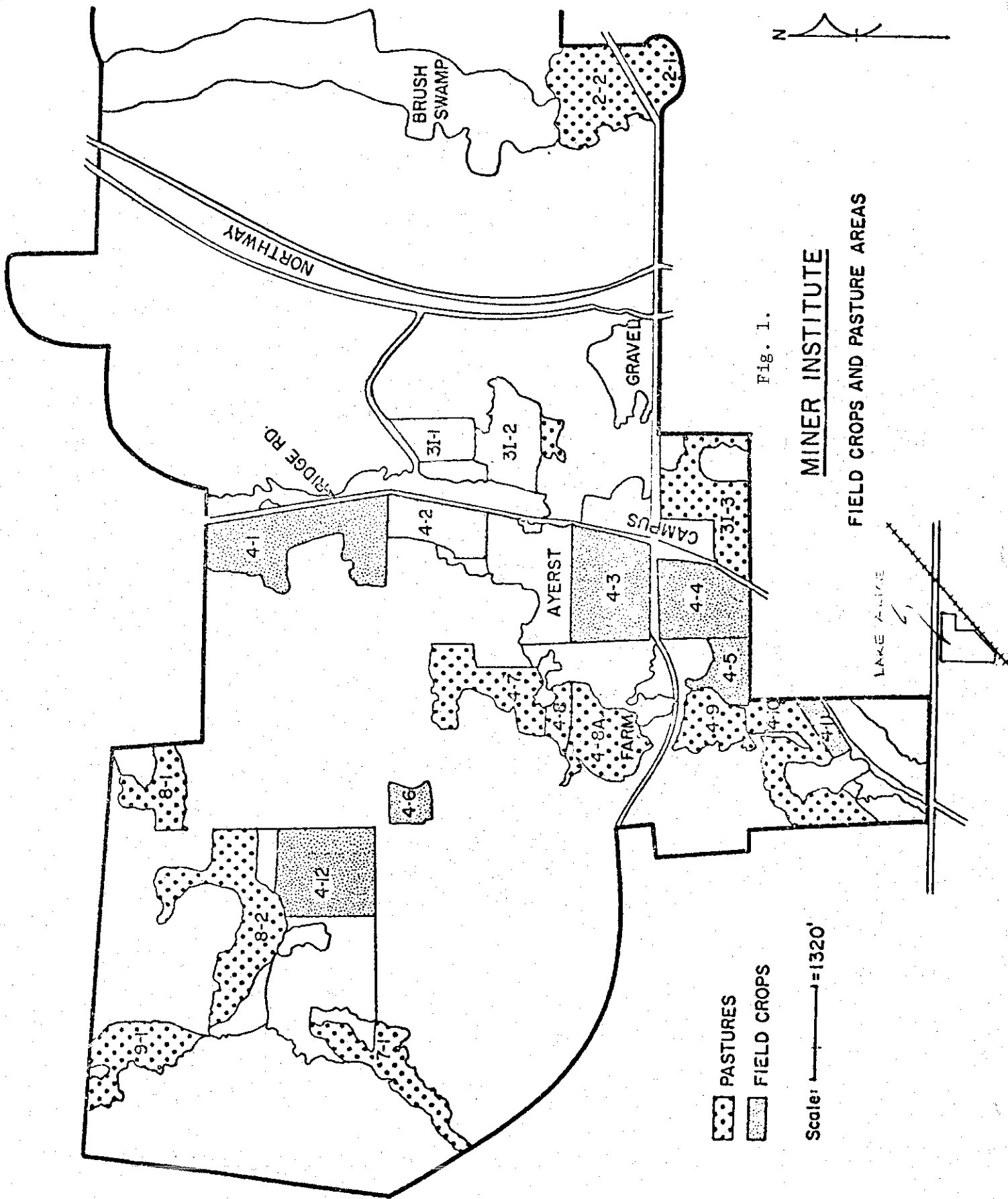

Fig. 1.

MINER INSTITUTE
FIELD CROPS AND PASTURE AREAS

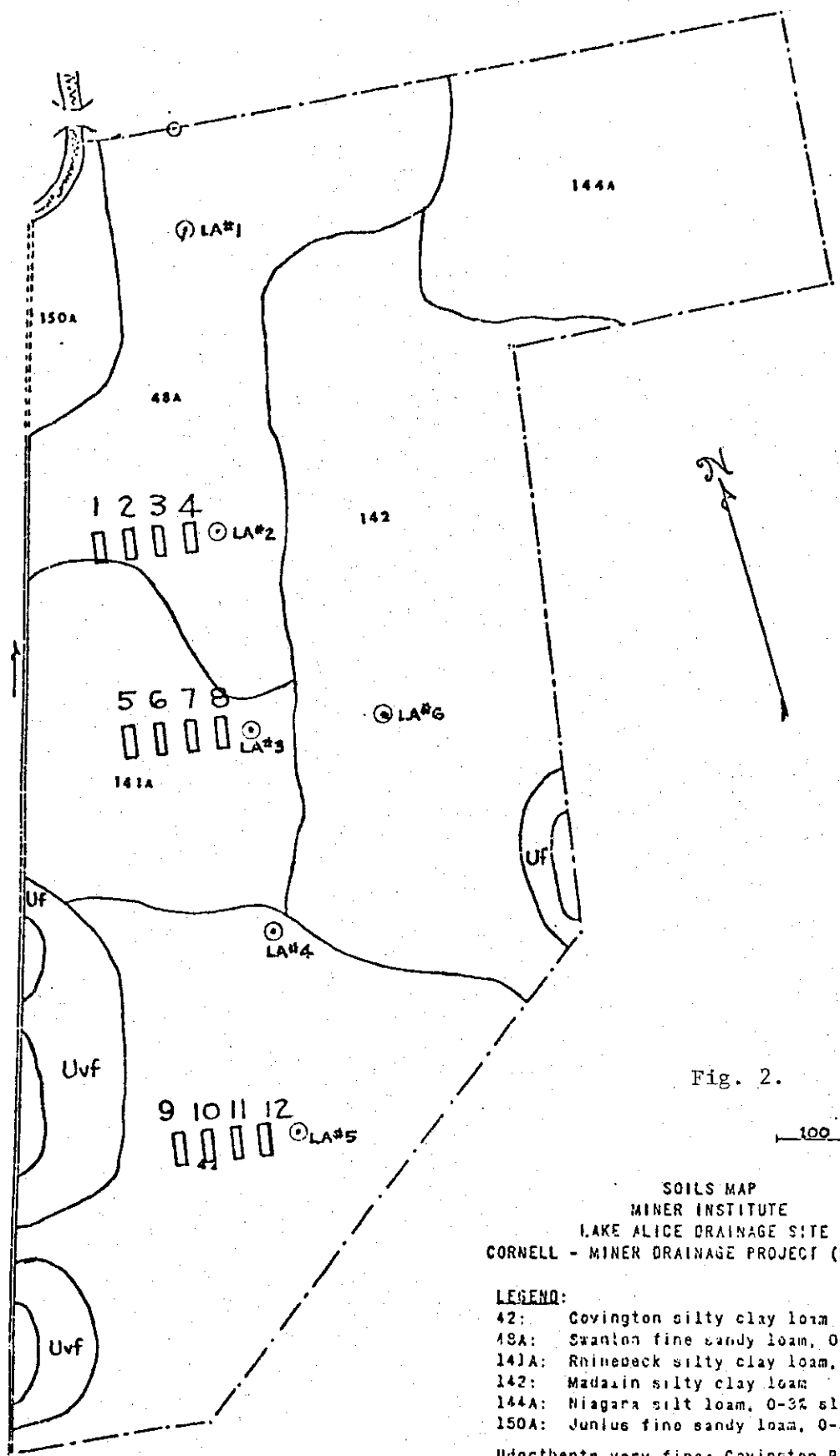

Fig. 2.

100 ft

SOILS MAP
 MINER INSTITUTE
 LAKE ALICE DRAINAGE SITE
 CORNELL - MINER DRAINAGE PROJECT (HATCH)

- LEGEND:
- 42: Covington silty clay loam
 - 42A: Swanton fine sandy loam, 0-5% slopes
 - 141A: Rhinebeck silty clay loam, 0-3% slopes
 - 142: Madalin silty clay loam
 - 144A: Niagara silt loam, 0-3% slopes
 - 150A: Junius fine sandy loam, 0-3% slopes

Udorthents very fine: Covington B&C horizons dug out to make ponds
 Udorthents fine: Rhinebeck or Madalin B&C horizons dug out to make ponds.

Soils mapped by F. Z. Hutton, Jr. JULY 1976
 Drafted by S. A. Barrows

⊙ LA#1 APPROXIMATE LOCATION OF WATER TABLE PIPE

5
 39" x 20' SUB-SAMPLE PLOTS

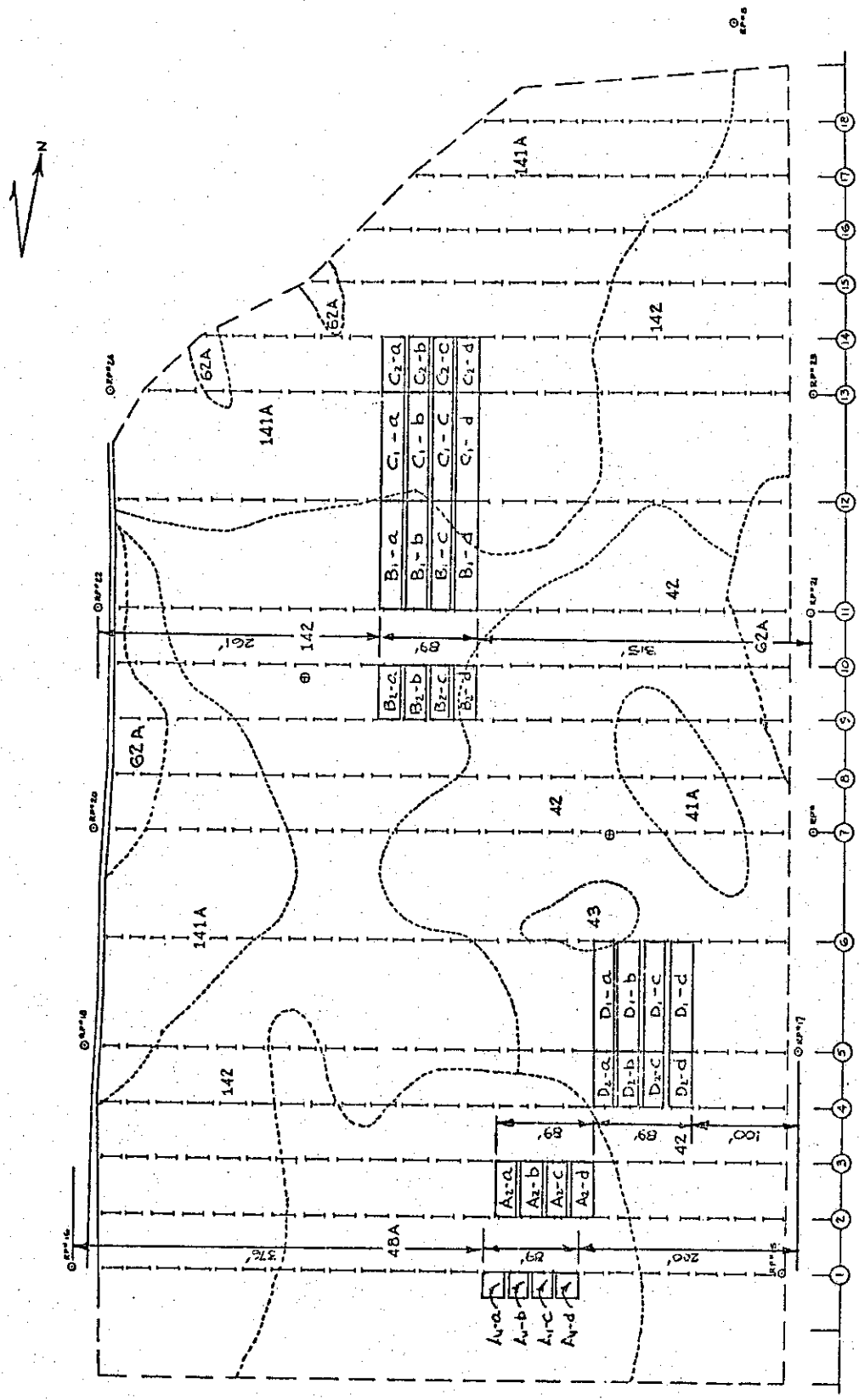

MINER INSTITUTE FIELD 31-1

SOILS MAP
(REVISED 6/76)

Scale: 0 50 100 FT.

RP denotes Reference Point - 3/4" IRON PIPE
X 6 FT. LONG DRIVEN INTO GROUND.
(F.B. p.47)

- SOILS**
- 41A MEDIUM BULKY CLAY LOAM, 0-3%
 - 42 COMBINATION BULKY CLAY LOAM
 - 43 LIGHT BULKY CLAY LOAM
 - 62A MEDIUM BULKY CLAY LOAM, 0-3%
 - 48A SANDY FINE BULKY LOAM, 0-3%
 - 141A COMBINATION BULKY CLAY LOAM, 0-3%
 - 142 MEDIUM BULKY CLAY LOAM
- ⊕ REFERENCE POINT OF SAMPLES WITH
--- DENOTES THE

Fig. 3.

Fig. 4.

A SUBPLOTS

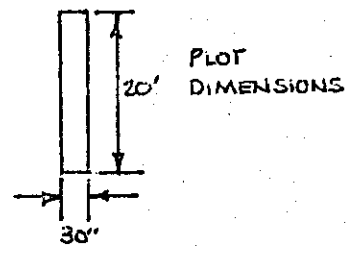
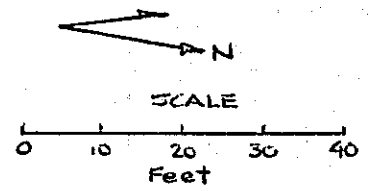
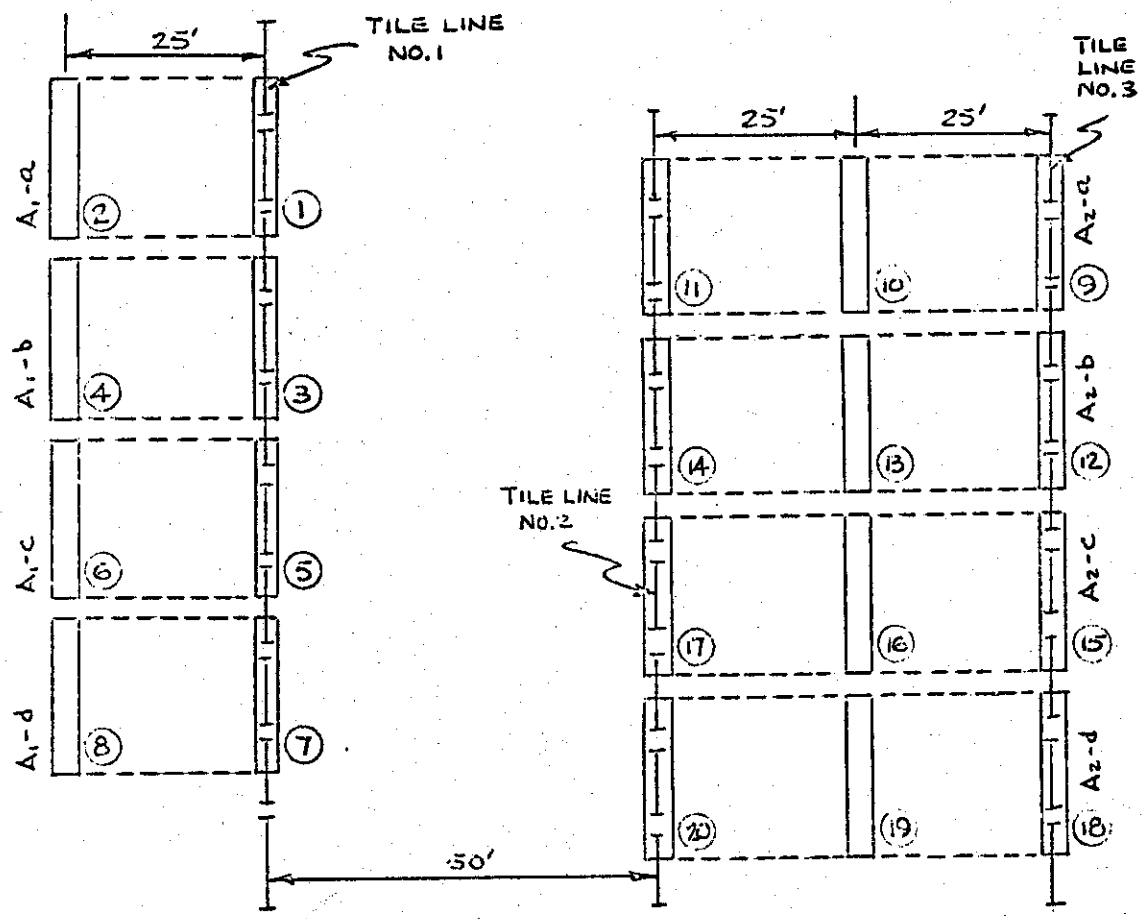

Fig. 5.

B SUBPLOTS

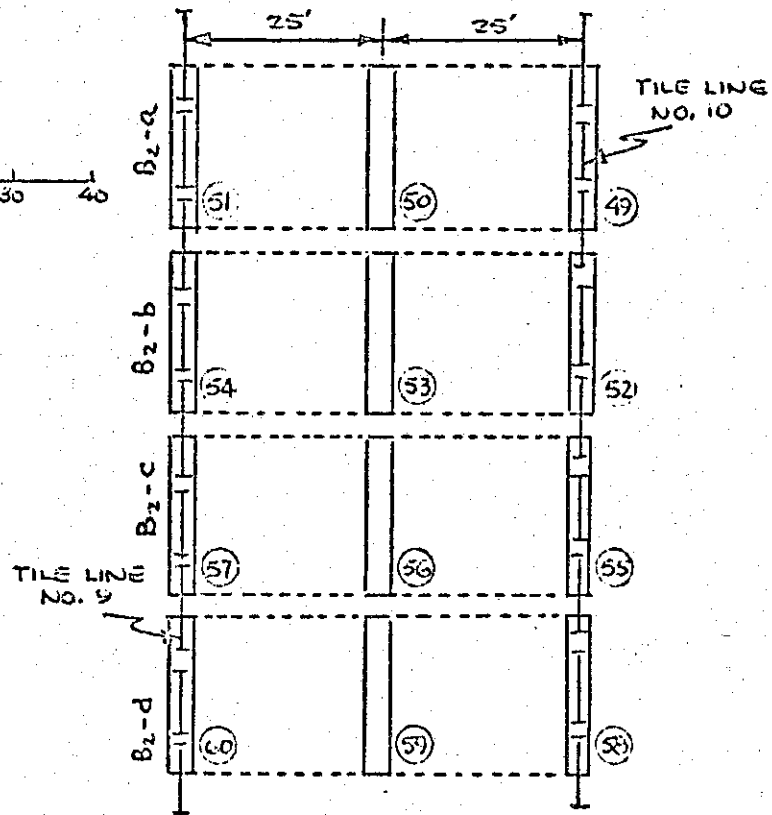
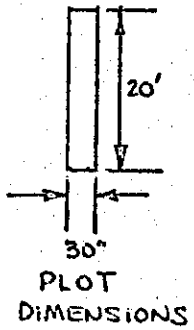
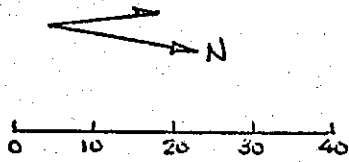
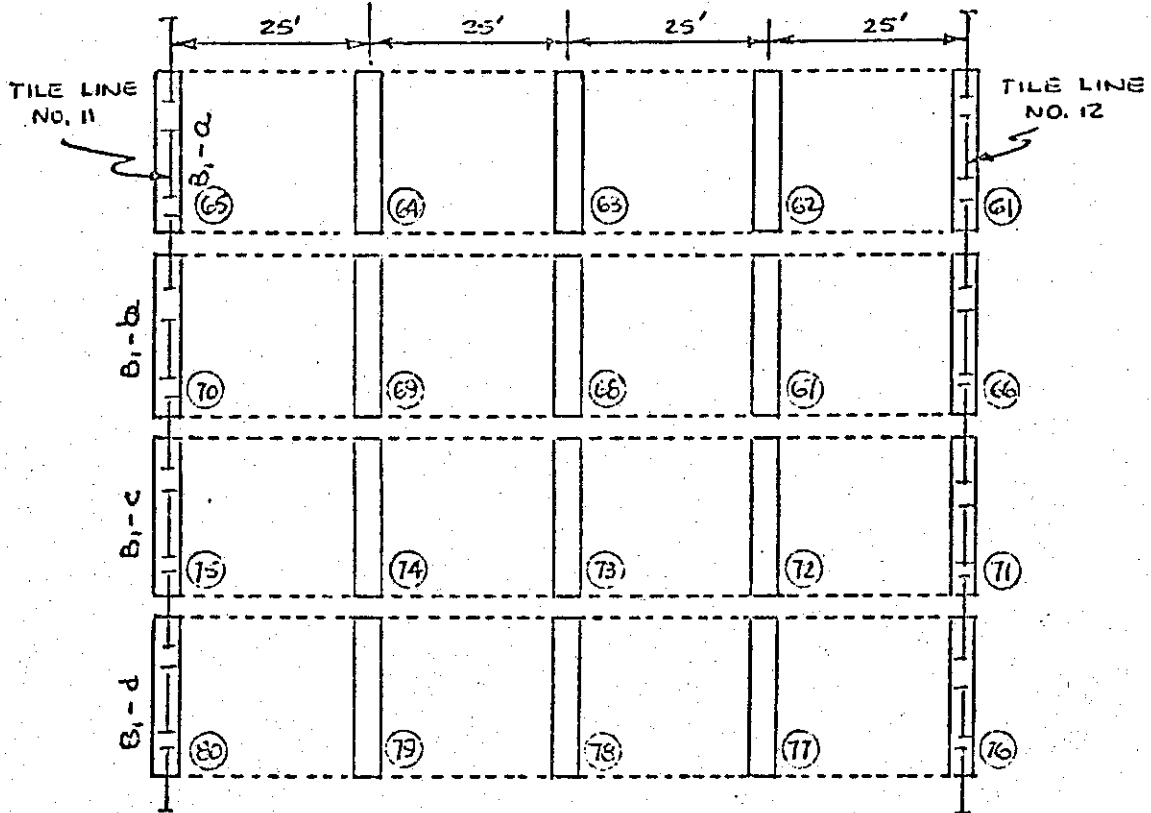

Fig. 6.

C SUBPLOTS

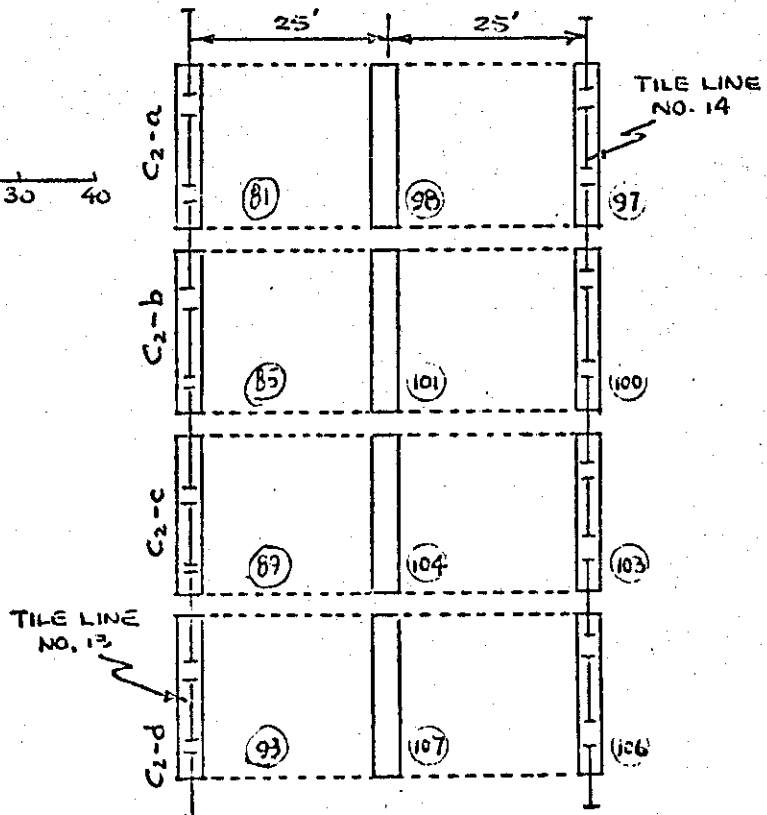
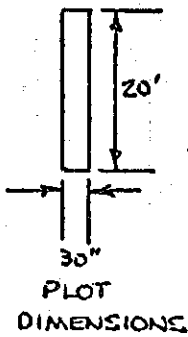
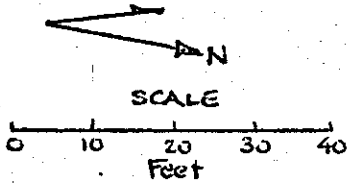
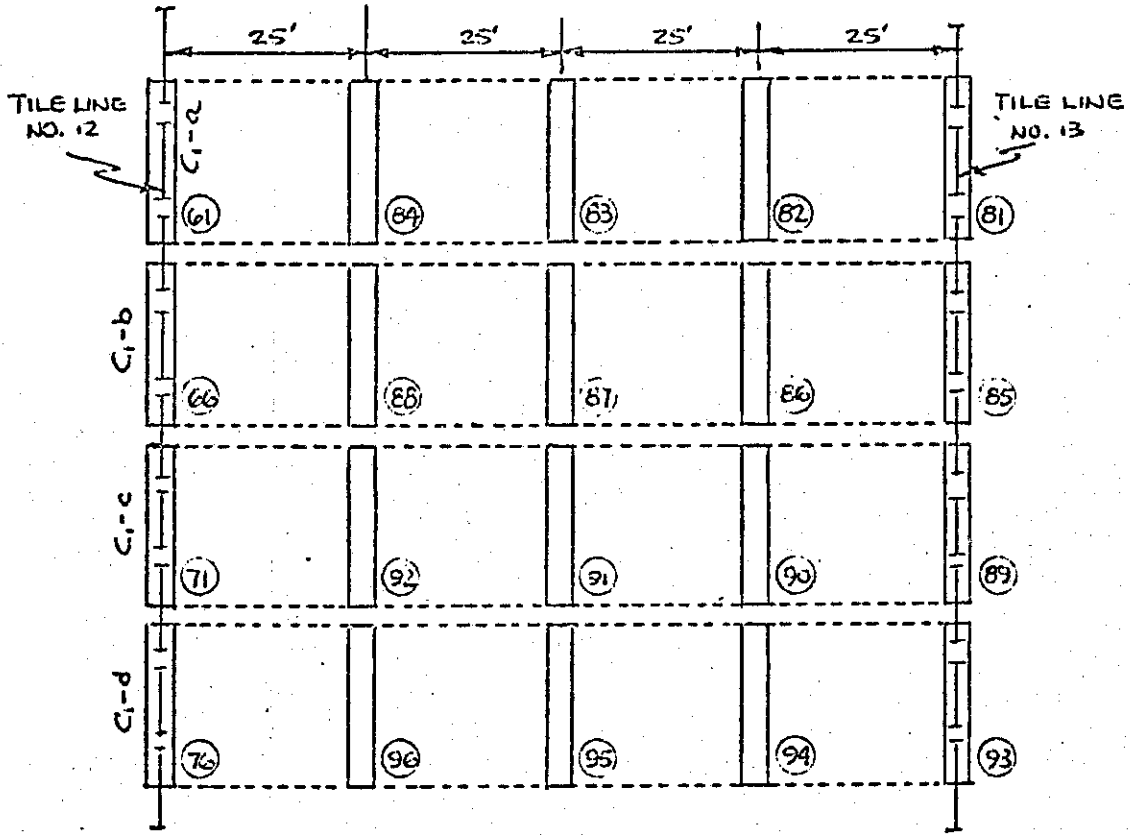
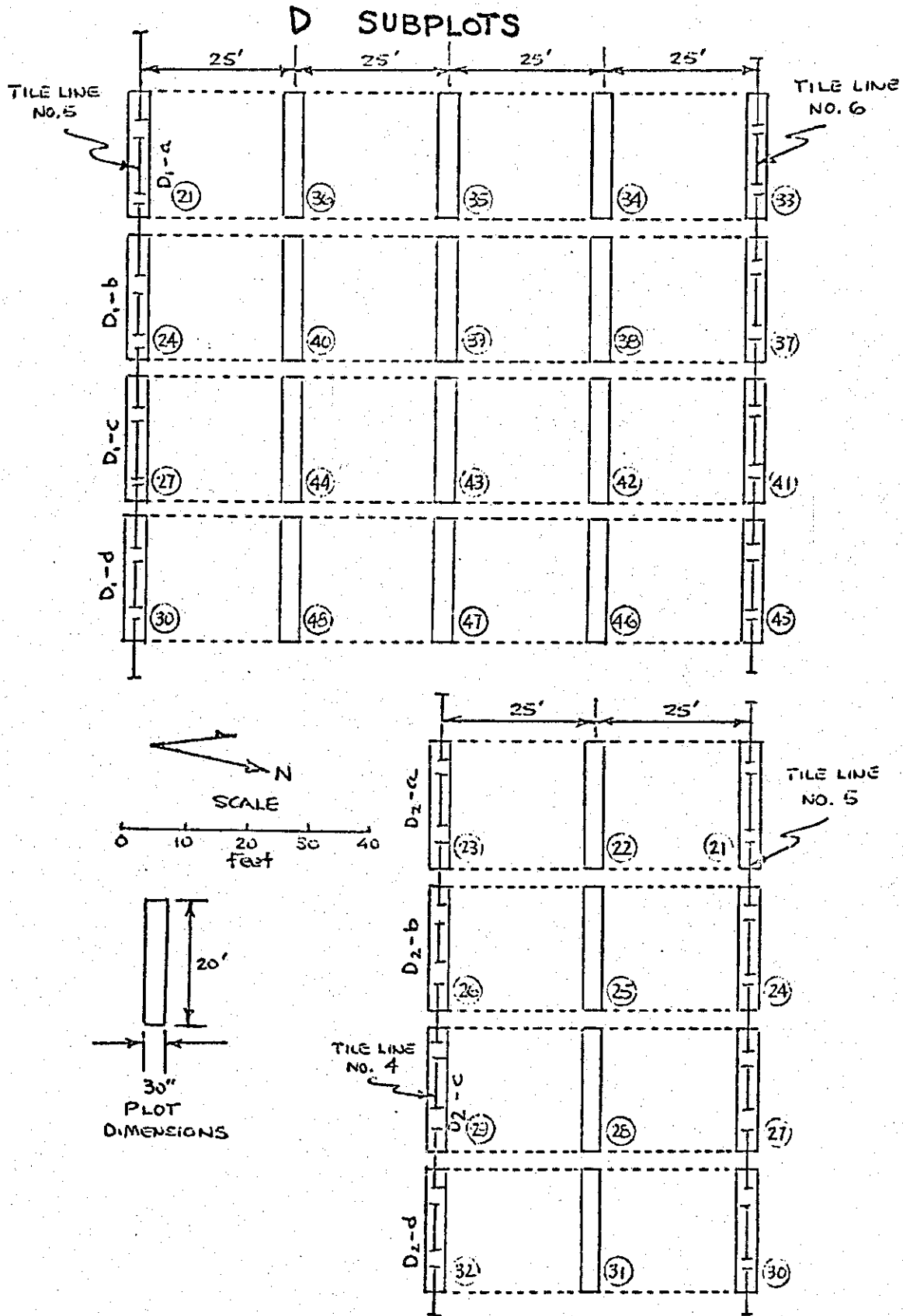

Fig. 7.



Cultural Practices & Yields

I. Lake Alice -

A. Sudangrass

Tillage: Chisel plowed (once); disked 3 times
 Pesticides: 4 lb/A Aatrex; 2 applications of 2 lbs/A
 Fertilizer: 0-0-60; 200 lb/A - broadcast on 7/11/78.
 10-10-10; 200 lb/A - at planting,
 34-0-0; 150 lb/A - topdressing (Ammonium Nitrate), 7/12/78

Planting: Sudangrass, var. "Piper." 35 lb/A - planted 6/29/78

Harvest: Plots harvested by hand, August 23, 1978.

field harvested with field machinery. All yields were weighed.

Yields

Table 1. Sudangrass Yields, Lake Alice, 1978

Sudangrass, T/A (@65% moisture)

Soil: Swanton fine sandy loam

Plot No:	1	2	3	MEAN	S
Silage Yield	4.28	3.52	4.33	3.92	+0.44

(T/A)

Soil: Rhinebeck silty clay loam

Plot No:	5	6	7	8	MEAN	S
Silage Yield	4.93	4.06	2.92	2.44	3.59	+1.12

(T/A)

Soil: Covington silty clay loam

Plot No:	9	10	11	12	MEAN	S
Silage Yield	0.86	2.88	3.65	2.68	2.52	+1.18

(T/A)

Total 1978 sudangrass silage production = 7.15 tons @ 65% moisture.

B. Native Meadow

Tillage: None

Pesticides: None

Planting: None

Fertilization: 0-0-60; 200 lb/A broadcast on 7/11/78

34-0-0; 150 lb/A broadcast on 7/12/78

Harvest: Field equipment, as dry hay (mow-rake-bale). Hay weights recorded.

Yields: 4.1 tons of baled hay from 5.5 acres, or 0.75 T/A of baled hay

II. Field 3I-2 (Surface drainage) - Corn

Tillage: chisel plowed (once), disked once

Pesticides: 4 lbs/A Aatrex; 2 (split) applications of 2 lbs/A. 1 lb/A Furadan (a.i.) at planting

Fertilizer: 0-0-60; 200 lb/A (broadcast) prior to planting

13-52-0; 135 lb/A at planting

32-0-0; 180 lb/A sidedressed (32% Nitro)-60 lbs/A of N.

Planting: Corn, Pioneer 3958. Planted; 5/11/78

Harvest: Harvested with field equipment; all loads were weighed and recorded. Field areas were divided as shown in Fig. 8, which shows dimensions, calculated acreages, and soil types.

Yields

Table 2. Corn silage, T/A (@ 70% moisture), Field 3I-2, 1978.

Soils: Rhinebeck		Swanton		Niagara	Madalin	Rhinebeck
Madalin		Madalin	Madalin	Swanton	Swanton	Madalin
Madalin		Madalin	Madalin	Rhinebeck	Whately	Whately
Plot No.	1A	1B	2A	2B	3A	3B
Drainage Treatment	Smoothed		Smoothed and Graded			Smoothed
Silage Yield (T/A)	21.4	22.4	15.4	16.2	15.0	11.7

Total 1978 silage production: 314.6 tons (70% moisture) or an average of 17.4 tons/acre.

III. Field 3I-1 (Subsurface drainage) - Corn

Tillage: Chiselled lightly (once) over the tile lines (E-W)
 Entire field chiselled (N-S), disked once.

Pesticides: 4 lbs/A Aatrex; 2 (split) applications of 2 lb/A
 1 lb/A Furadan (a.i.) at planting

Fertilizer: 0-0-60; 200 lb/A (broadcast) before planting
 13-52-0; 135 lb/A at planting
 32-0-0; 180 lb/A sidedressed (32 % Nitran) - 60 lbs/A of N

Planting: Corn, Pioneer 3958. Planted 5/10/78

Harvest: Subplots: 5 x 20 feet. One 20-ft row was hand-picked to
 obtain grain yield data, then chopped to obtain stover yield
 data.
 One 20-ft row chopped mechanically to obtain silage yield data.
 Subplot designations and locations are shown in Figures 3-7.

Yields:

A. 50 foot drain spacing

Table 3. Mean Silage Yields, T/A (70% moisture), Field 3I-1, 1978.

Plot Area ^{1/}	Soil	Treatment ^{2/}		
		A	B	C
A ₂	Swanton fsl	26.5 ^{a3/}	24.3 ^a	25.0 ^a
B ₂	Madalin sic1	19.8 ^a	22.8 ^a	22.8 ^a
C ₂	Rhinebeck sic1	21.5 ^a	22.2 ^a	19.5 ^a
D ₂	Covington sic1	19.5 ^b	21.2 ^b	24.8 ^a

Table 4. Mean Grain Yields, Bu/A (15% moisture), Field 3I-1, 1978.

Plot Area ^{1/}	Soil	Treatment ^{2/}		
		A	B	C
A ₂	Swanton fsl	178.5 ^{a3/}	168.0 ^a	174.4 ^a
B ₂	Madalin sic1	142.0 ^a	164.4 ^a	164.8 ^a
C ₂	Rhinebeck sic1	160.7 ^a	165.8 ^a	147.7 ^a
D ₂	Covington sic1	134.6 ^b	156.0 ^{ab}	168.1 ^a

^{1/} See plot location maps (Figures 4-7).

^{2/} Treatments are distances (in feet) from the drain line: A = 0 feet,
 B = 25 feet, C = 0 feet.

^{3/} Means superscripted by the same letter are not significantly
 different at P = 0.05 (Duncan's Multiple Range Test).

B. 100-foot drain spacing:Table 5. Mean Silage Yields, T/A (70% moisture), Field 3I-1, 1978

Plot Area ^{1/}	Soil	Treatment ^{2/}				
		A	B	C	D	E
A ₁	Swanton fsl	24.3 ^{a3/}	27.2 ^a	-	-	-
B ₁	Madalin sicl	18.9 ^c	20.5 ^{bc}	21.6 ^{abc}	24.1 ^a	22.8 ^{ab}
C ₁	Rhinebeck sicl	19.5 ^a	18.2 ^a	20.8 ^a	20.4 ^a	18.9 ^a
D ₁	Covington sicl	19.6 ^b	19.5 ^b	20.2 ^b	23.8 ^a	19.5 ^b

Table 6. Mean Grain Yields, Bu/A (15% moisture), Field 3I.1, 1978

Plot Area ^{1/}	Soil	Treatment ^{2/}				
		A	B	C	D	E
A ₁	Swanton fsl	162.2 ^{a3/}	186.2 ^a	-	-	-
B ₁	Madalin sicl	142.3 ^b	155.6 ^{ab}	158.2 ^{ab}	168.2 ^a	164.5 ^a
C ₁	Rhinebeck sicl	147.7 ^a	145.6 ^a	156.2 ^a	156.1 ^a	142.3 ^a
D ₁	Covington sicl	146.3 ^{ab}	143.0 ^{ab}	148.6 ^{ab}	165.0 ^a	134.6 ^b

^{1/} See plot location maps (Figures 4-7).

^{2/} Treatments are distances (in feet) from the drain line: A = 0 feet, B = 25 feet, C = 50 feet, E = 0 feet.

^{3/} Means superscripted by the same letter are not significantly different at P = 0.05 (Duncan's Multiple Range Test).

IV. Field 4-2^{1/}

Tillage: chisel plowed once,
 Pesticides: 2 lb/A Lasso + 1 lb/A Aatrex
 Fertilizer: 12 T/A manure before tillage
 32-0-0: 180 lb/A sidedress (32 % Nitro) 60 lbs/A of N

Planting: Corn, Pride R-121. Planted 5/16/78.

Harvest: Harvested by the same procedure as in Field 3I-1 except that the subplots were 2 rows x 25 feet long: 3 plots in the well drained portion, 3 plots in the poorly drained portion, and 3 plots over the large tile drain.

Yields:

Table 7. Corn Silage, T/A (@ 70% moisture), Field 4-2, 1978.

	Plot No. and Portion of Field		
	Well Drained	Poorly Drained	Over Tile Line
(1)	24.6	(4) 8.9	(7) 33.2
(2)	36.2	(5) 14.5	(8) 36.8
(3)	27.9	(6) 6.2	(9) 39.8
MEAN	29.6	9.9	36.6
S	+ 6.0	+ 4.2	+ 3.3

Table 8. Corn Grain, Bu/A (@ 15% moisture) Field 4-2, 1978

	Plot No. and Portion of field		
	Well Drained	Poorly Drained	Over Tile Line
(1)	183.0	(4) 57.5	(7) 241.4
(2)	268.3	(5) 111.3	(8) 276.6
(3)	232.4	(6) 39.3	(9) 230.2
MEAN	227.9	69.4	249.4
S	+ 42.8	+ 37.4	+ 24.2

^{1/} Field 4-2 is not formally included in the Hatch 498 Project. The data are included to document the effects of drainage on crop yields.

YIELD RESPONSES TO DRAINAGE

Lake Alice:

The intention was to crop all the cropland areas in the same way. This was not possible in 1978, since the non-drained area at Lake Alice was too wet to make a timely planting of corn. Because of this prolonged wetness, it was judged unlikely that a successful corn crop could be grown. The relative values of corn and sudangrass as silage would make improved drainage seem profitable; but one season does not establish the profitability of drainage. This experiment should define how frequently a substitute crop is necessary and the relative costs and returns of such substitutions.

Field 3I-2:

Block #1 apparently produced more corn silage than blocks 2 or 3. Any of the yield levels appear to be acceptable.

Field 4-2:

The data clearly show the effects of drainage, and repeat a general pattern which has been documented since about 1973.

Field 3I-1:

50-foot spacing: There were very few differences in yield as a function of distance from the drain. This essentially repeats the response observed with Sudangrass in 1977 (see Agronomy Mimeo 78-20).

100-foot spacing: Few yield response differences were noted; and some that were may well be the effect of soil disturbance during the installation of the drains.

DISCUSSION

The general level of yields was very high, and probably marks 1978 as an exceptional year for corn yields. The rainfall was below the long term mean (LTM) as indicated in Figure 9. The combined rainfall for May and June approximated the LTM for those 2 months; 5.5 actual inches vs 5.6 inches (LTM). Rainfall in July, August and September was about 1 inch less than LTM for each of those months.

Since drainage is a method of removing excess soil water, one would expect reduced responses to drainage in a drier-than-normal season.

The mean yields of grain and silage in field 3I-1, over all soil types were:

50 foot spacing: Grain, 160.5 bu/A; Silage, 22.5 T/A

100 foot spacing: Grain, 157.3 bu/A; Silage, 21.9 T/A.

Clearly, there were no substantial differences attributable to tile spacings in 1978. It should be remembered, however, that this field had been too wet to cultivate prior to the drainage installation, and had not been cropped for about 30 years because of the wetness problem.

It is also interesting to note that, in field 3I-1, there were high yield levels in the poorly drained, fine textured Covington soils, which normally show limited responses to subsurface drainage. The mean yields for Covington soils were:

50 foot spacing: Grain, 152.9 bu/A; Silage, 21.8 T/A

100 foot spacing: Grain, 147.5 bu/A; Silage, 20.5 T/A.

While the drier-than-normal season prevents observations about the relative effectiveness of the tile spacings, the data illustrated the productivity of Covington soils when excess soil water does not limit plant growth.

It is quite possible to contrast the corn yields in field 3I-1 to the Sudangrass yields from the Lake Alice site. The Lake Alice site would have been planted to corn, if possible. It was not possible, because the soils were too wet during the normal corn planting season. A comparison of silage yields on similar soils at the 2 locations provides the following data:

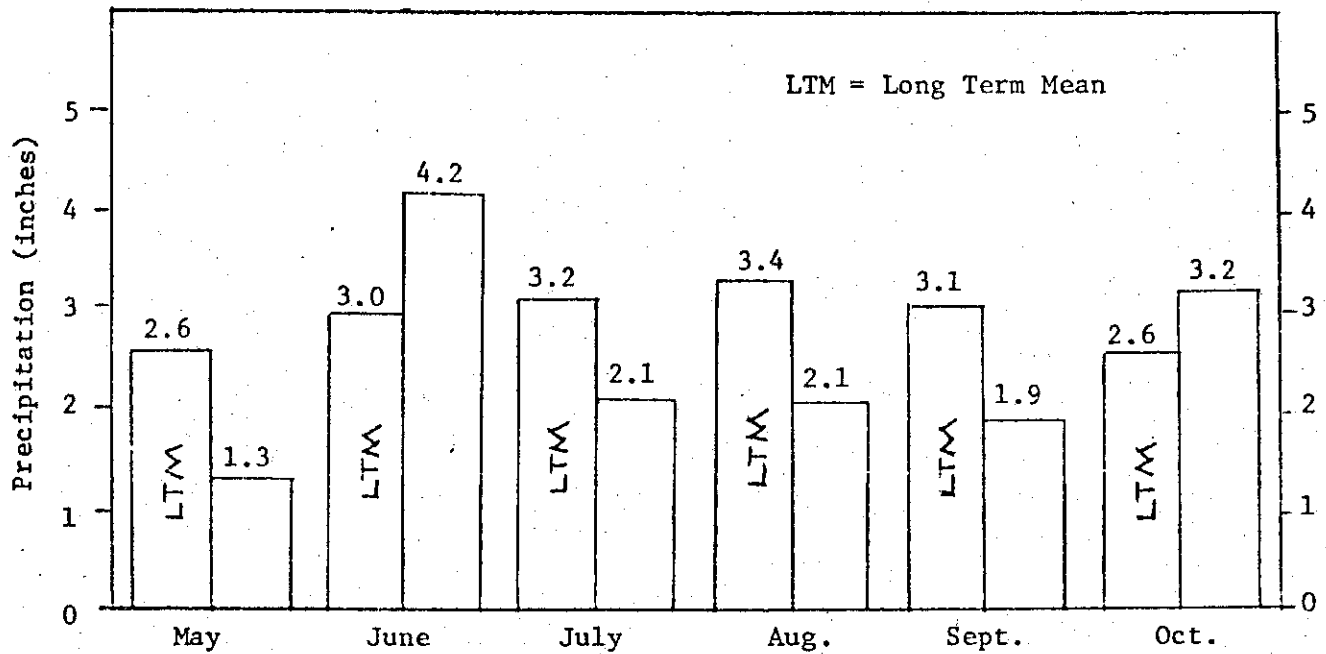

Fig. 9. Growing season rainfall, Chazy, N.Y., 1978.

Table 9. Silage yields on similar soils, Lake Alice and Field 3I-1

Soil	Silage Yield, tons/acre	
	Lake Alice (Sudangrass)	Field 3I-1 (corn)
Swanton fsl	3.9	25.6
Rhinebeck sic1	3.6	20.4
Covington sic1	2.5	21.2

It should also be noted (Tables 7 & 8) that silage yields in field 4-2 were nearly 4 times as high where the soil had adequate artificial drainage than where it had not; and that corn grain yields were similarly higher where the naturally poorly drained soil had been drained.

SOIL-WATER RESPONSES and TILE OUTFLOW

F.N. Swader and L.D. Geohring

METHODS

In addition to crop yield data, the influence of drainage on the levels of water in the soil were monitored, by installing perforated plastic pipes in the soil. The pipe locations are shown in figures 2, 10, 10a.

Twelve pipes were installed in field 3I-1, between tile lines #6 and #8, and six were installed between tile lines 2 and 3. The depth to the water surface was measured intensively from April 19 through June 30, and less frequently thereafter. The data are shown in Appendix B.

Six pipes were installed at the Lake Alice site (Figure 2), and similarly monitored. These provide a non-drained comparison for many of the soils which occur in field 3I-2. The data are shown in Appendix C.

Water table pipes were also installed in field 3I-2 at distances of 1, 30 and 45 feet upslope from a subsurface drain which is located at the boundary of 3I-2 and the adjacent pasture to the west, and in locations in field 3I-4 which are located where the subsurface drain would have been if it were extended to the north, and 30 feet on either side of such an extension. These data are shown in Appendix D and E, respectively.

Tile outflow measurements were begun in June 1978 and continued throughout the year on tile lines 3, 6, 9 and 12 in field 3I-1.

During June (when monthly precipitation was greater than the long term mean see Fig. 9) tile outflow measurements were made almost daily. As the soil moisture became depleted, and throughout the remainder of the season, flow measurements were conducted on a weekly basis until winter snow and freeze-up.

The tile outflows data are shown in Appendix F. The data were gathered by catching the outflow for a specific period of time, measuring it, and calculating the flow in gallons per minute (gpm). It should be noted that these are instantaneous values, and may not accurately represent tile flow for any entire day, or perhaps even a significant portion of a day.

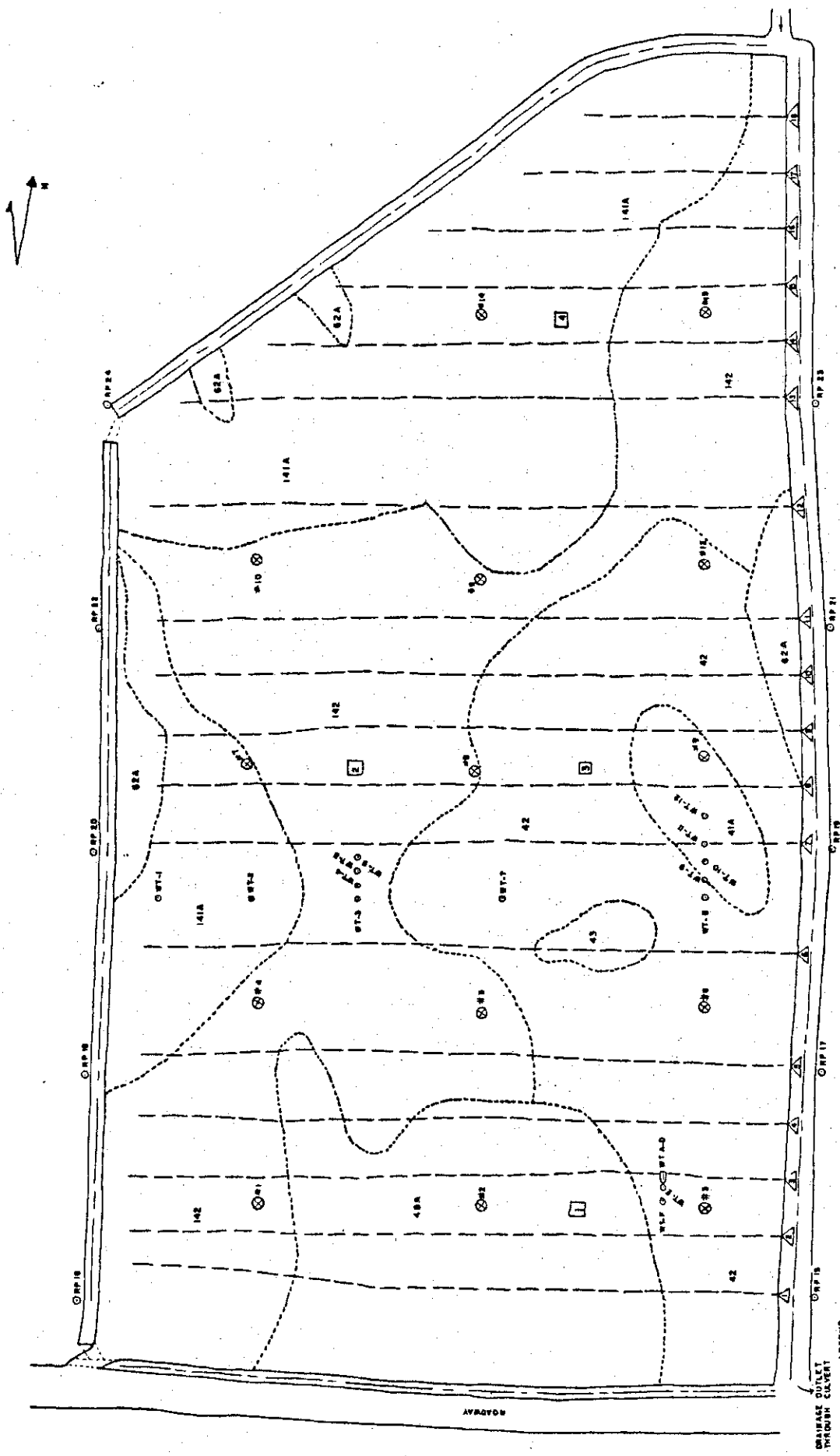

DEPARTMENT OF AGRICULTURAL ENGINEERING NEW YORK STATE COLLEGE OF AGRICULTURE AND LIFE SCIENCES A DIVISION OF THE STATE UNIVERSITY AT CORNELL UNIVERSITY ITHACA, NEW YORK			
MAKER INSTITUTE FLD. 11-1 GENERAL FIELD LOCATION MAP REVISED 7/73			
DR BY	DATE	SHEET	PLAN
WALTER SALLUS	7/73	1	1
REV BY	DATE		
	7/23/79		

- SOILS
- 41A KINGSBURY SILTY CLAY LOAM 0-3%
 - 42 COVINGTON SILTY CLAY LOAM
 - 43 LIVINGSTON RICKY SILTY CLAY LOAM
 - 44 WARRENA CORNBALT LOAM 0-3%
 - 45 MARSHALL SILTY CLAY LOAM 0-3%
 - 46 MARSHALL SILTY CLAY LOAM
- SCALE 1" = 100'

- LEGEND
- SOIL BOUNDARY
 - GRAVITY DRAIN
 - WATER TABLE PIPE
 - WATER TABLE PIPES A-D
 - DIRECTLY OVER DRAIN 3
 - 10' SOUTH OF A
 - 5' SOUTH OF A
 - 10' SOUTH OF B
 - REFERENCE POINT
 - AUGER HOLES FOR HYDRAULIC CONDUCTIVITY TESTS
 - SECTION PIT SAMPLING SITES
 - CENTER LINE OF OPEN DRAINAGE
 - CONVEY
 - SHOW DIRECTION OF WATER FLOW

Figure 10.

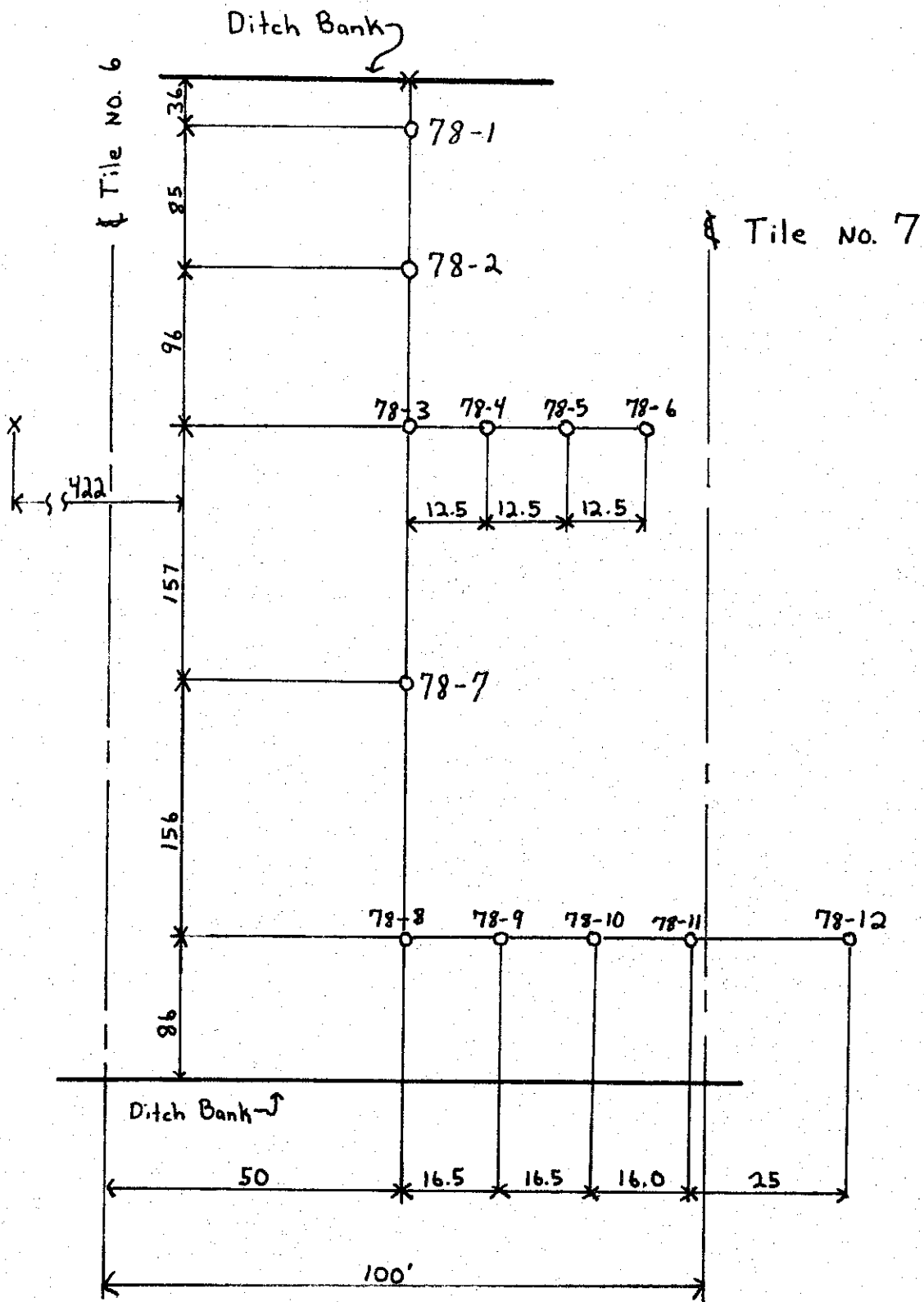
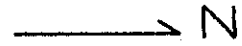

Figure 10a. Water Table Pipes
Miner Institute-Fld 3I-1
installed 6/27/77

DISCUSSION

The daily rainfall and evaporation for the summer months are shown in table 10, and in graphic form in figure 9 (page 17). Rainfall was well below normal for the months of April and (especially) May.

Even with an unusually dry period, however, the effects of drainage on the depth to the water table are quite apparent. Figure 11 illustrates the effect of drainage on water table depths in Covington and Madalin soils. Covington soils are not as well drained (naturally) as are Madalin soils, although the non-drained areas (at Lake Alice) behave similar to one another. When the drained situations are compared, it is clear that - even at a distance of 50 feet from the drain, the water table in the Madalin soil is lower (deeper) than that in Covington soil.

The Covington soil did respond to subsurface drainage, however. Over the period from May 11 through June 15, the water table was about 18 inches lower in the drained Covington soil than in the non-drained Covington soil; and the rainfall of June 1 (1.1 inches) hardly influenced the water table in either of the drained soils, but caused a significant rise of the water table in the non-drained soils.

Another comparison of soil response to drainage is shown in figure 12, which shows the variations in depth to the water table in Covington soils at various distances from a subsurface drain over a period of 13 days. During the same time period, the water table in a non-drained Covington soil dropped by about 1 foot (LAWT-3, Appendix C).

Depending upon the degree of drainage improvement desired, and the willingness to invest in drainage, Covington soils can be drained. Subsurface drains at 100 foot spacings would require 436 feet of drain per acre of cost of \$220-\$350/acre.

The costs would double if drains were placed 50 feet apart. Some indication of the effectiveness of subsurface drains at 50 foot spacings is given in Figure 13, which compares water table levels at distances of 25

Table 10. Rainfall and Evaporation, Miner Institute, 1978

Date	April		May		June		July		August	
	Pptn	Evap	Pptn	Evap	Pptn	Evap	Pptn	Evap	Pptn	Evap
1	0.40	N/A	-	-	1.10	0.17	-	0.22	0.10	0.29
2	-		-	0.17	-	0.11	-	0.19	-	0.20
3	-		T	0.13	0.19	0.23	-	0.10	T	0.28
4	-		-	0.10	-	0.06	-	0.18	0.67	0.14
5	0.60		-	0.08	-	0.07	-	0.18	-	0.07
6	-		-	0.28	0.13	0.08	-	0.31	-	0.21
7	-		-	0.15	-	0.22	-	0.25	-	0.13
8	0.13		-	0.08	0.61	0.35	-	0.27	-	0.15
9	-		0.11	0.23	-	0.22	0.15	0.22	0.25	0.13
10	-		0.06	0.11	0.10	0.09	-	0.06	0.03	0.17
11	0.24		0.02	0.09	-	0.15	T	0.14	-	0.16
12	0.12		-	0.19	-	0.12	-	0.20	T	0.22
13	T		-	0.11	0.06	0.26	-	0.31	0.04	0.12
14	-		-	0.29	0.46	0.21	0.06	0.29	-	0.30
15	-		0.11	0.12	T	0.12	-	0.27	-	0.34
16	-		0.25	0.21	-	0.27	-	0.24	-	0.36
17	-		0.48	0.17	-	0.29	0.47	0.10	0.14	0.29
18	-		0.02	0.20	0.24	0.21	-	0.28	-	0.17
19	-		-	0.09	0.12	0.03	-	0.18	-	0.26
20	0.41		-	0.11	0.75	0.20	-	0.05	-	0.19
21	0.12		0.27	0.18	0.26	0.10	-	0.09	T	0.20
22	-		T	0.12	0.09	0.16	0.46	0.30	-	0.14
23	-		-	0.19	-	0.08	0.13	0.16	-	0.11
24	-		-	0.36	0.05	0.11	0.46	0.19	0.35	0.24
25	-		-	0.16	-	0.31	-	0.28	0.09	0.03
26	-		-	0.35	-	0.21	-	0.20	-	0.18
27	-		-	0.21	-	0.14	-	0.28	T	0.10
28	-		-	0.29	0.07	0.17	0.05	0.11	T	0.01
29	-		-	0.21	T	0.14	-	0.25	0.42	0.01
30	-		-	0.28	-	0.32	0.36	0.06	-	0.11
31	-		-	0.23	-	-	T	0.03	-	0.25
Totals	2.02		1.32		4.23		2.14		2.09	
LTM*	2.50		2.59		3.00		3.16		3.35	

*Long Term Mean

Water table elevations - Miner Inst., 1978

Madalin and Covington Soils

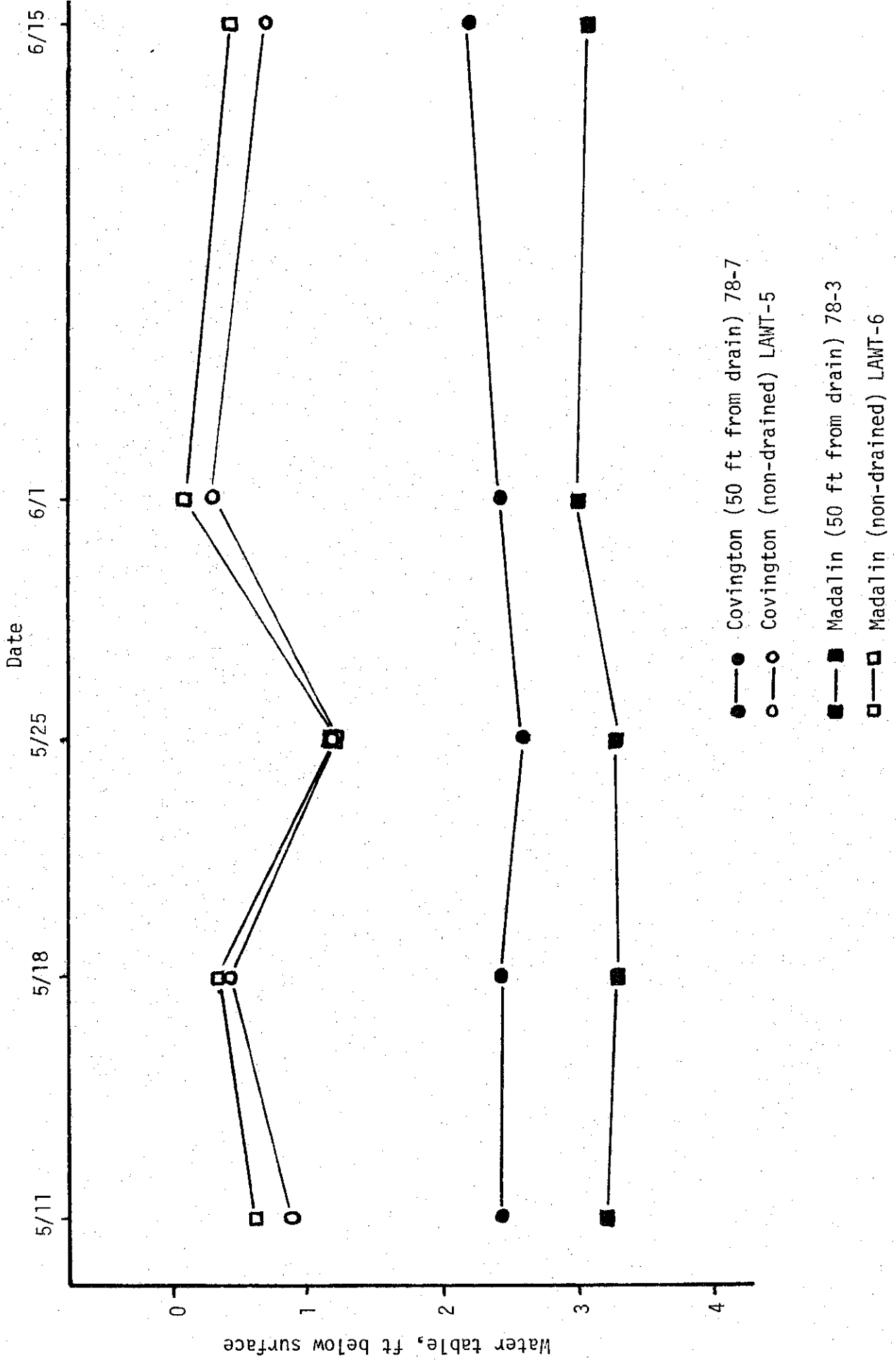

Figure 11.

Figure 12.

Water Table Depths - Miner Institute, 1978

Covington Soils

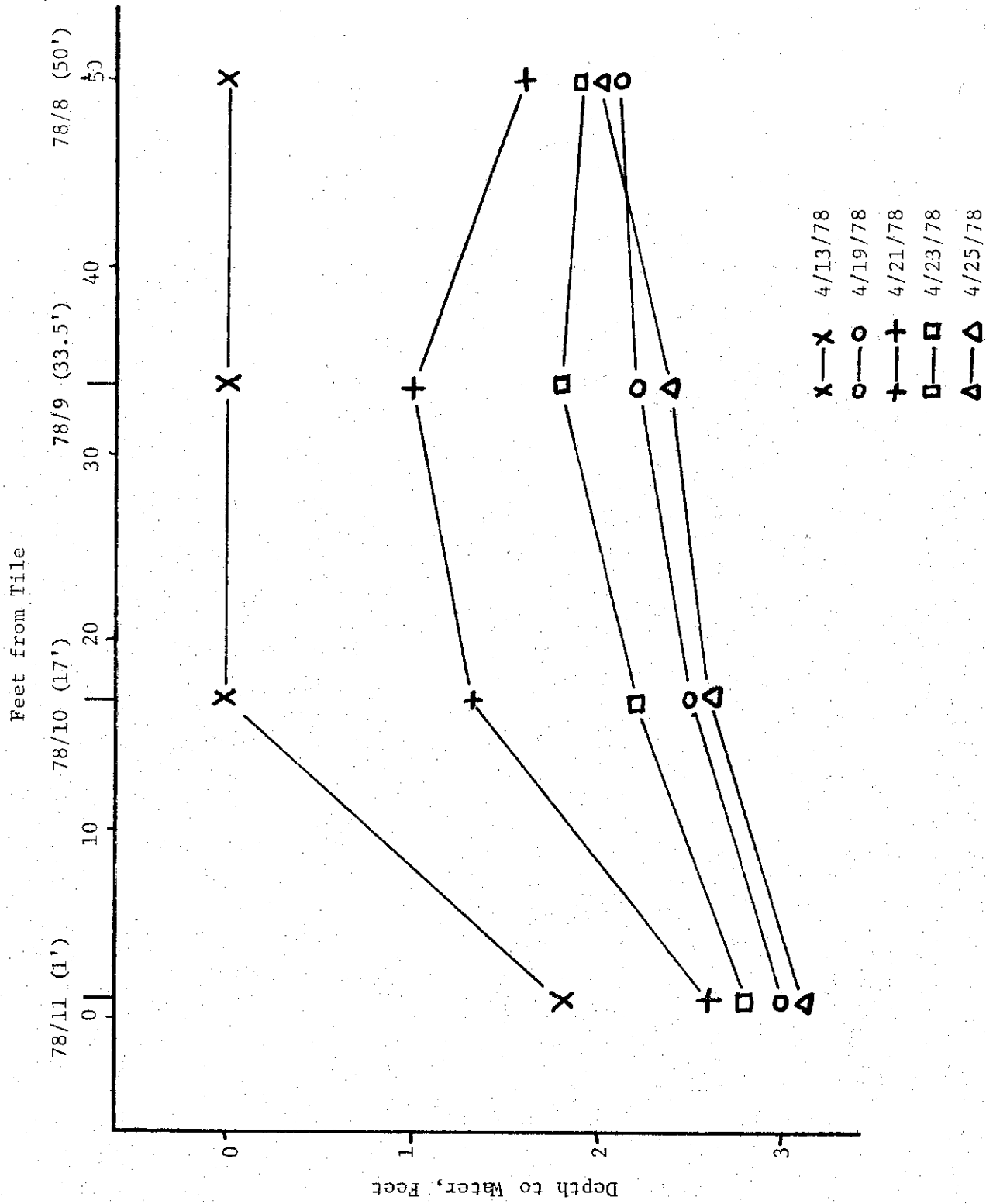
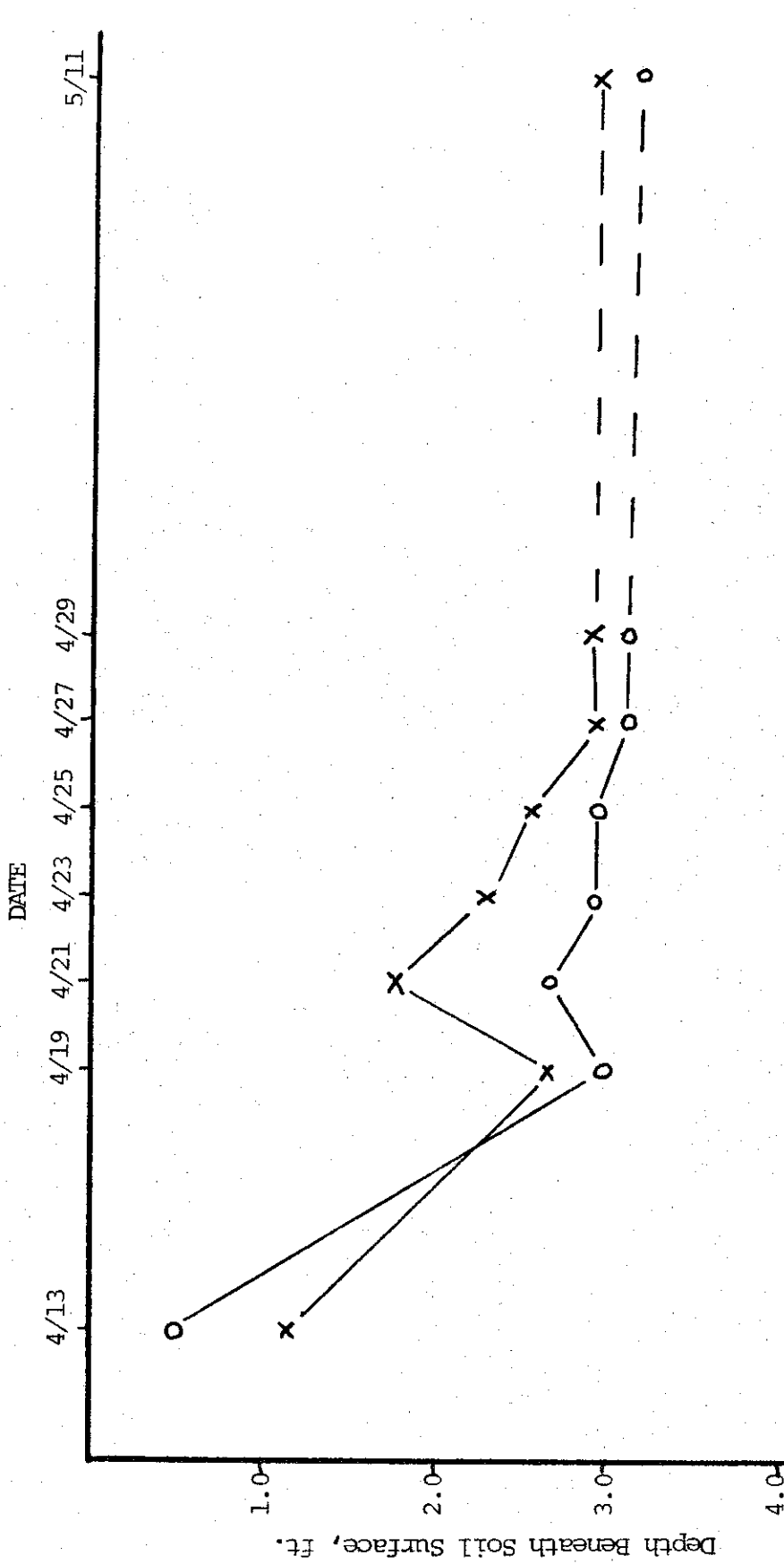

Figure 13. Water Table Elevations - Miner Institute, 1978
 Madalin and Covington Soils



X — 78-12 Covington, 25 ft. from drain
 O — 78-3 Madalin, 50 ft. from drain

and 50 feet from a subsurface drain. These graphs indicate that, if drained at a 50-foot spacing, Covington soils will react much as Madalin soils drained at a 100 foot spacing.

Such data emphasize the importance of knowing the location and distribution of soils within a farm, to make knowledgeable choices about which soils to drain and how they are likely to respond.

Drain outflow data are shown in Figure 14. They seem to indicate that drain #6 has a more rapid and greater response to rainfall than the other drains that were tested. There is no apparent reason for such a response, based on the soils on their distribution over the various drains. Some leakage was observed at the outlet to drain #12. Continuous monitoring of the tile flows would provide valuable information about differences in drain discharge and the annual pattern of drain flow in these soils and climatic conditions.

Figure 14.
Miner Institute, 1978
Field 3I - 1.

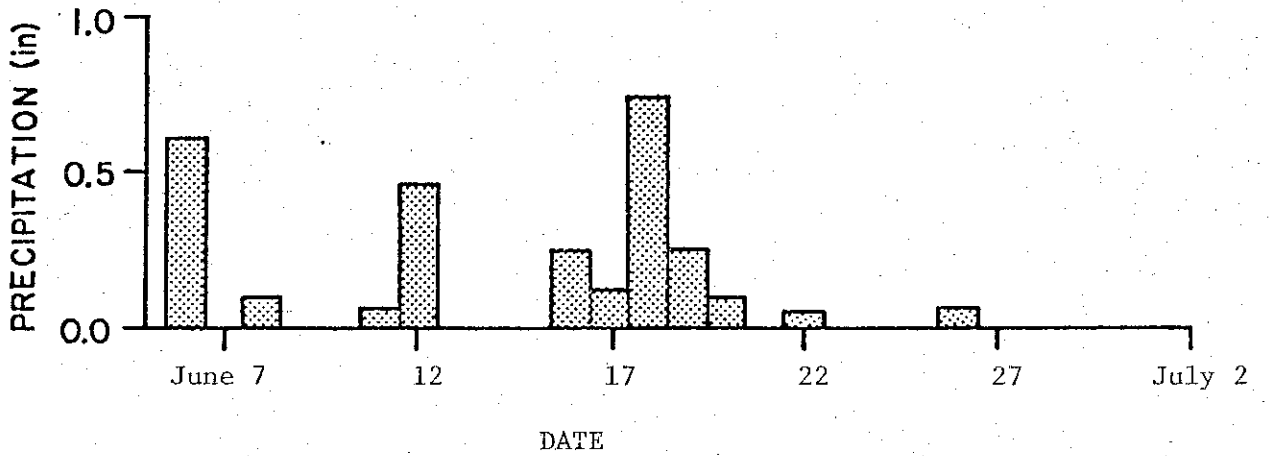
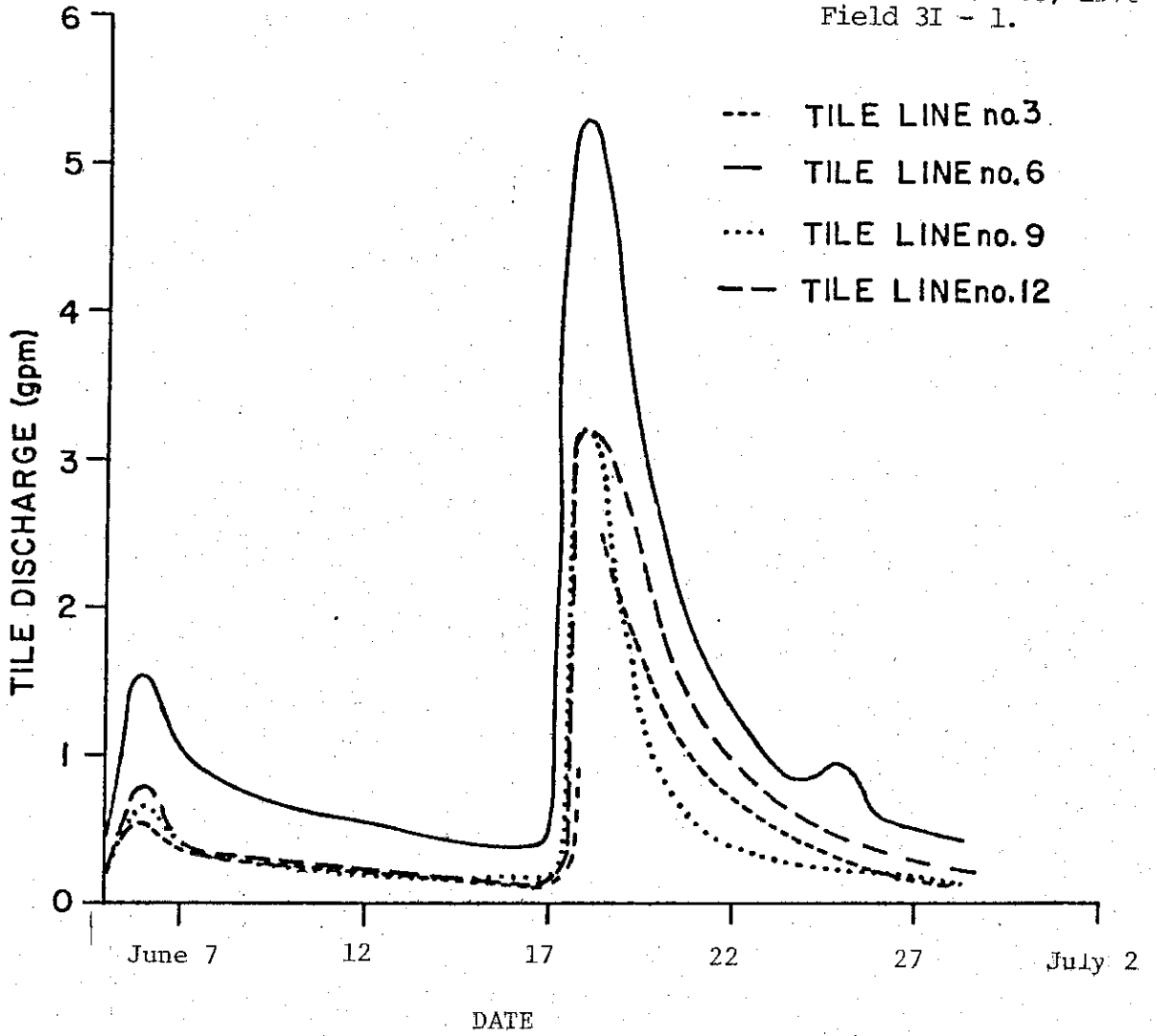

APPENDIX A.
CORN YIELDS - MINER INSTITUTE 1978
FIELD 3I-1

PLOT	TREATMENT (Spacing, Feet)	GRAIN YIELD (Bu/A @ 15%)	SILAGE YIELD (T/A @ 70%)	
A ₁	1	0	158.24	22.58
	2	25	154.10	22.98
	3	0	176.76	26.24
	4	25	179.12	27.20
	5	0	160.44	23.22
	6	25	206.82	29.70
	7	0	169.36	25.32
	8	25	204.90	28.70
A ₂	9	0	174.24	24.54
	10	25	144.82	22.06
	11	0	162.22	22.74
	12	0	185.36	25.10
	13	25	199.24	29.22
	14	0	172.94	25.14
	15	0	179.24	24.52
	16	25	148.22	22.00
	17	0	183.06	26.62
	18	0	175.06	31.88
	19	25	180.00	23.82
	20	0	179.54	25.62
D ₂	21	0	163.50	22.32
	22	25	178.74	24.50
	23	0	158.52	23.00
	24	0	138.52	19.66
	25	25	157.84	20.34
	26	0	177.80	26.22
	27	0	120.84	18.08
	28	25	149.92	20.98

PLOT	TREATMENT (spacing, Feet)	GRAIN YIELD (Bu/A @ 15%)	SILAGE YIELD (T/A @ 70%)
29	0	161.16	25.02
30	0	115.62	17.98
31	25	137.70	19.04
32	0	174.94	25.24
D ₁ 33	0	146.92	19.66
34	25	140.36	20.14
35	50	157.78	21.44
36	25	174.12	23.46
(21)	0	(163.50)	(22.32)
37	0	158.74	20.72
38	25	144.86	19.72
39	50	140.64	18.84
40	25	163.44	22.54
(24)	0	(138.52)	(19.66)
41	0	144.02	19.48
42	25	157.64	20.76
43	50	163.90	22.08
44	25	154.76	25.16
(27)	0	(120.84)	(18.08)
45	0	135.60	18.56
46	25	129.26	17.40
47	50	132.22	18.56
48	25	167.94	23.80
(30)	0	(115.62)	(17.98)
B ₂ 49	0	120.14	16.86
50	25	180.94	24.06
51	0	150.22	21.84
52	0	149.16	21.14
53	25	156.24	22.28
54	0	166.28	23.04
55	0	161.48	22.28
56	25	163.20	21.64
57	0	168.26	23.10
58	0	137.38	19.06
59	25	157.52	22.98
60	0	174.58	23.42

PLOT	TREATMENT (Spacing, Feet)	GRAIN YIELD (Bu/A @ 15%)	SILAGE YIELD (T/A @ 70%)	
B ₁	61	0	142.32	19.58
	62	25	165.92	20.44
	63	50	149.72	19.70
	64	25	158.24	22.26
	65	0	169.50	22.72
	66	0	123.62	16.76
	67	25	159.86	21.96
	68	50	161.70	22.40
	69	25	160.02	22.74
	70	0	158.24	22.18
	71	0	151.72	19.02
	72	25	144.22	19.20
	73	50	171.92	23.58
	74	25	175.54	27.18
	75	0	172.68	24.04
	76	0	146.62	20.34
77	25	152.62	19.96	
78	50	149.28	20.84	
79	25	179.34	24.22	
80	0	157.50	22.40	
C ₂	97	0	173.00	22.64
	98	25	185.90	24.76
	(81)	0	(168.08)	(20.18)
	100	0	156.18	20.30
	101	25	141.06	19.22
	(85)	0	(173.94)	(22.04)
	103	0	144.82	20.66
	104	25	170.86	22.52
	(89)	0	(132.20)	(17.50)
	106	0	168.76	22.50
107	25	165.06	22.24	
(93)	0	(116.64)	(18.32)	

PLOT	TREATMENT (spacing, feet)	GRAIN YIELD (Bu/A @ 15%)	SILAGE YIELD (T/A @ 70%)
C ₁ 81	0	168.80	20.18
82	25	145.66	17.24
83	50	175.12	23.12
84	25	162.48	20.98
(61)	0	(142.32)	(19.58)
85	0	173.94	22.04
86	25	167.56	19.90
87	50	157.06	19.90
88	25	159.76	20.10
(66)	0	(128.62)	(16.76)
89	0	132.20	17.50
90	25	140.46	19.00
91	50	149.50	20.86
92	25	151.42	20.24
(71)	0	(151.72)	(19.02)
93	0	116.64	18.32
94	25	128.80	16.52
95	50	143.12	19.32
96	25	150.82	20.30
(76)	0	(146.62)	(20.34)

APPENDIX E.
 WATER TABLE ELEVATIONS - MINER INSTITUTE 1978
 FIELD 3I-1

Calendar Date	Julian Date	WATER TABLE PIPES									
		A		B		C		D		E	
		Water Table Elevation (feet)	Feet Below Ground Surface	Water Table Elevation (feet)	Feet Below Ground Surface	Water Table Elevation (feet)	Feet Below Ground Surface	Water Table Elevation (feet)	Feet Below Ground Surface	Water Table Elevation (feet)	Feet Below Ground Surface
4/7	97	171.09	2.59	170.86	2.78	172.21	1.54	Ice	Ice	Ice	-----
4/9	99	<170.30	>3.38	170.56	3.08	171.86	1.89	172.58	173.20	173.20	1.05
4/10	100	170.94	2.74	171.05	2.59	171.71	2.04	173.34	173.19	173.19	0.29
4/11	101	171.47	2.21	171.58	2.06	171.86	1.89	173.63	173.28	173.28	0.21
4/13	103	171.09	2.59	170.71	2.93	172.66	1.09	173.15	172.82	172.82	0.67
4/19	109	<170.30	>3.38	171.31	2.33	171.26	2.49	171.65	170.63	170.63	2.86
4/20	110	<170.30	>3.38	170.66	2.98	171.25	2.50	171.98	170.92	170.92	2.57
4/21	111	<170.30	>3.38	170.56	3.08	171.17	2.58	172.08	170.93	170.93	2.56
4/22	112	<170.30	>3.38	170.56	3.08	171.16	2.59	172.02	170.88	170.88	2.61
4/23	113	<170.30	>3.38	170.56	3.08	171.11	2.64	171.94	170.88	170.88	2.61
4/24	114	<170.30	>3.38	170.56	3.08	171.08	2.67	171.84	170.83	170.83	2.66
4/25	115	<170.30	>3.38	170.56	3.08	171.03	2.72	171.82	170.83	170.83	2.66
4/26	116	<170.30	>3.38	170.56	3.08	170.96	2.79	171.81	170.83	170.83	2.66
4/27	117	<170.30	>3.38	170.51	3.13	170.96	2.79	171.74	170.83	170.83	2.66
4/29	119	<170.30	>3.38	170.51	3.13	170.93	2.82	171.68	170.82	170.82	2.67
5/11	131	171.07	2.61	170.71	2.93	171.36	2.39	170.78	170.47	170.47	3.02
5/18	138	<170.30	>3.38	170.49	3.15	170.62	3.13	170.18	170.52	170.52	2.97
5/25	145	<170.30	>3.38	170.52	3.12	170.52	3.23	171.00	170.46	170.46	3.03
6/1	152	<170.30	>3.38	170.46	3.18	170.66	3.09	171.03	170.88	170.88	2.61
6/6	157	<170.30	>3.38	170.55	3.09	170.61	3.14	171.07	170.78	170.78	2.71
6/7	158	<170.30	>3.38	170.52	3.12	170.63	3.12	171.07	170.78	170.78	2.71
6/8	159	<170.30	>3.38	170.52	2.52	170.61	3.14	170.29	170.83	170.83	2.66
6/9	160	<170.30	>3.38	170.45	3.19	170.58	3.17	170.90	171.73	171.73	1.76
6/12	163	<170.30	>3.38	170.48	3.16	170.55	3.20	171.18	170.81	170.81	2.68
6/13	164-1	<170.30	>3.38	170.47	3.17	170.55	3.20	171.18	170.78	170.78	2.71
6/13	164-2	<170.30	>3.38	170.45	3.19	170.53	3.22	171.14	170.75	170.75	2.74
6/13	164-3	<170.30	>3.38	170.47	3.17	170.53	3.22	171.14	170.76	170.76	2.73
6/14	165	<170.30	>3.38	170.52	3.12	170.58	3.17	171.14	170.71	170.71	2.78
6/15	166	<170.30	>3.38	170.43	3.21	170.55	3.20	171.14	170.65	170.65	2.84
6/16	167	<170.30	>3.38	170.45	3.19	170.53	3.22	171.11	170.62	170.62	2.87
6/19	170	<170.30	>3.38	170.45	3.19	170.55	3.20	171.19	170.62	170.62	2.87
6/21	172-1	<170.30	>3.38	170.45	3.19	170.58	3.17	172.46	171.40	171.40	2.09
6/21	172-2	<170.30	>3.38	170.61	3.03	170.70	3.05	172.47	171.73	171.73	1.76

APPENDIX B.
WATER TABLE ELEVATIONS - MINER INSTITUTE 1978
FIELD 31-1

Calendar Date	Julian Date	WATER TABLE PIPES									
		A		B		C		D		E	
		Water Table Elevation (feet)	Feet Below Ground Surface	Water Table Elevation (feet)	Feet Below Ground Surface	Water Table Elevation (feet)	Feet Below Ground Surface	Water Table Elevation (feet)	Feet Below Ground Surface	Water Table Elevation (feet)	Feet Below Ground Surface
6/22	173	<170.30	>3.38	170.58	3.06	170.72	3.03	172.28	1.35	171.27	2.22
6/23	174	<170.30	>3.38	170.53	3.11	170.72	3.03	172.13	1.50	171.04	2.45
6/26	177	<170.30	>3.38	170.47	3.17	170.67	3.08	171.87	1.76	170.68	2.81
6/27	178	<170.30	>3.38	170.45	3.19	170.67	3.08	171.78	1.85	170.65	2.84
6/28	179	<170.30	>3.38	170.42	3.22	170.65	3.10	171.13	2.50	170.60	2.89
6/29	180	<170.30	>3.38	170.42	3.22	170.65	3.10	171.67	2.50	170.57	2.92
6/30	181	<170.30	>3.38	170.40	3.24	170.60	3.15	171.59	2.04	170.50	2.99
7/5	186	<170.30	>3.38	170.36	3.28	170.50	3.25	171.42	2.21	170.32	3.17
7/6	187	<170.30	>3.38	170.30	3.34	170.45	3.30	171.37	2.26	170.27	3.22
7/7	188	<170.30	>3.38	170.29	3.35	170.42	3.33	171.32	2.31	170.22	3.27
7/10	191	<170.30	>3.38	170.12	3.52	170.31	3.44	171.23	2.40	169.99	3.50
7/11	192	<170.30	>3.38	170.09	3.55	170.26	3.49	171.21	2.42	169.93	3.56
7/12	193	<170.30	>3.38	170.06	3.58	170.21	3.54	171.13	2.50	169.88	3.61
7/13	194	<170.30	>3.38	170.01	3.63	170.12	3.63	171.08	2.55	169.83	3.66
7/16	197	<170.30	>3.38	169.94	3.70	170.04	3.71	171.01	2.62	169.80	3.69
7/26	207	<170.30	>3.38	169.88	3.76	169.99	3.76	170.98	2.65	169.80	3.69
7/27	208	<170.30	>3.38	169.86	3.78	169.99	3.76	170.91	2.72	169.76	3.73
8/2	213	<170.30	>3.38	169.83	3.81	169.96	3.79	170.59	3.04	169.42	4.07
8/31	242	<170.30	>3.38	169.91	3.73	169.56	4.19	170.18	3.45	169.73	3.76
9/7	249	<170.30	>3.38	169.81	3.83	<169.56	>4.19	170.03	3.60	<169.33	>4.16
9/14	256	<170.30	>3.38	---	---	<169.56	>4.19	---	---	---	---
9/21	263	<170.30	>3.38	169.76	3.88	<169.56	>4.19	169.93	3.70	<169.33	>4.16
9/28	270	<170.30	>3.38	169.71	3.93	<169.56	>4.19	169.63	4.00	<169.33	>4.16
10/5	277	<170.30	>3.38	169.64	4.00	<169.56	>4.19	169.13	4.50	<169.33	>4.16
10/12	284	<170.30	>3.38	169.84	3.80	169.71	4.04	169.80	3.83	169.60	3.89
10/26	297	170.82	2.86	169.81	3.83	169.65	4.10	169.63	4.00	169.48	4.01
11/2	304	170.49	3.19	169.75	3.89	<169.56	>4.19	169.53	4.10	169.58	3.91
11/8	311	170.54	3.14	169.64	4.00	<169.56	>4.19	168.88	4.75	169.63	3.86
11/16	318	170.49	3.19	<169.64	>4.00	<169.56	>4.19	169.48	4.15	169.43	4.06
11/22	324	170.44	3.24	<169.64	>4.00	<169.56	>4.19	169.38	4.25	169.38	4.11
11/30	332	170.44	3.24	<169.64	>4.00	<169.56	>4.19	169.38	4.25	169.33	4.16
12/14	346	<170.30	>3.38	170.36	3.28	169.41	4.34	170.38	3.25	170.38	3.11
12/22	354	<170.30	>3.38	170.38	3.26	170.36	3.39	170.84	3.29	170.23	3.26

APPENDIX B.
WATER TABLE ELEVATIONS - MINER INSTITUTE 1978
FIELD 3I-1

Calendar Date	Julian Date	WATER TABLE PIPES									
		F		78-1		78-2		78-3		78-4	
		Water Table Elevation (feet)	Feet Below Ground Surface	Water Table Elevation (feet)	Feet Below Ground Surface	Water Table Elevation (feet)	Feet Below Ground Surface	Water Table Elevation (feet)	Feet Below Ground Surface	Water Table Elevation (feet)	Feet Below Ground Surface
4/7	97	Ice	----	177.22	0.68	Ice	---	Ice	---	Ice	---
4/9	99	----	----	176.11	1.79	175.45	0.61	174.36	0.76	174.00	0.95
4/10	100	173.36	0.12	176.59	1.31	175.85	0.21	174.67	0.45	174.10	0.85
4/11	101	173.29	0.19	177.05	0.85	176.06	0.00	175.12	0.00	174.95	0.00
4/13	103	173.48	0.00	176.19	1.71	175.68	0.38	174.66	0.46	174.95	0.00
4/19	109	171.93	1.55	173.92	3.98	173.48	2.58	172.16	2.96	173.45	1.50
4/20	110	173.08	0.40	173.92	3.98	173.37	2.69	172.12	3.00	173.35	1.60
4/21	111	----	----	174.09	3.81	173.36	2.70	172.45	2.67	173.35	1.60
4/22	112	173.34	0.14	174.08	3.82	173.35	2.71	172.43	2.69	173.33	1.62
4/23	113	171.90	1.58	174.00	3.90	173.34	2.72	172.32	2.80	173.30	1.65
4/24	114	171.27	2.21	173.90	4.00	173.27	2.79	172.24	2.88	173.25	1.70
4/25	115	171.24	2.24	173.89	4.01	173.16	2.90	172.21	2.91	173.16	1.79
4/26	116	171.19	2.29	173.88	4.02	173.14	2.92	172.03	3.09	173.12	1.83
4/27	117	171.19	2.29	173.82	4.08	173.06	3.00	172.02	3.10	173.08	1.87
4/29	119	171.15	2.33	173.82	4.08	172.98	3.08	171.98	3.14	173.03	1.92
5/11	131	<170.00	>3.48	174.50	3.40	172.30	3.76	171.89	3.23	171.54	3.41
5/18	138	170.96	2.52	174.54	3.36	172.00	4.06	171.84	3.28	172.14	2.81
5/25	145	170.94	2.54	174.45	3.45	172.14	3.92	171.85	3.27	171.29	3.68
6/1	152	171.74	1.74	174.40	3.50	171.71	4.35	172.09	3.03	171.53	3.42
6/6	157	171.61	1.87	174.39	3.51	172.28	3.78	172.04	3.08	171.40	3.55
6/7	158	171.55	1.93	174.36	3.54	172.63	3.43	171.96	3.16	171.29	3.66
6/8	159	171.78	1.70	174.40	3.50	172.73	3.33	172.24	2.88	172.09	2.86
6/9	160	171.66	1.82	174.35	3.54	172.68	3.38	172.29	2.83	172.04	2.91
6/12	163	171.48	2.00	174.49	3.41	172.72	3.34	172.11	3.01	172.09	2.86
6/13	164-1	171.42	2.06	174.49	3.41	172.70	3.36	172.06	3.06	172.07	2.88
6/13	164-2	171.40	2.08	174.49	3.41	172.68	3.38	172.05	3.07	172.04	2.91
6/13	164-3	171.43	2.05	174.49	3.41	172.67	3.39	172.03	3.09	172.06	2.89
6/14	165	171.38	2.10	174.49	3.41	172.73	3.33	172.05	3.07	172.10	2.85
6/15	166	171.33	2.15	174.49	3.41	172.72	3.34	172.05	3.07	172.07	2.88
6/16	167	171.28	2.20	174.49	3.41	172.73	3.33	172.02	3.10	172.06	2.89
6/19	170	171.55	1.93	174.49	3.41	172.70	3.36	171.97	3.15	172.06	2.89
6/21	172-1	172.84	0.64	175.18	2.72	173.03	3.03	173.85	1.27	172.79	2.16
6/21	172-2	172.73	0.75	175.84	2.06	174.93	1.13	174.08	1.04	174.00	0.94

APPENDIX B.
WATER TABLE ELEVATIONS - MINER INSTITUTE 1978
FIELD 3I-1

Calendar Date	Julian Date	WATER TABLE PIPES																			
		F				78-1				78-2				78-3				78-4			
		Water Table Elevation (feet)	Feet Below Ground Surface	Water Table Elevation (feet)	Feet Below Ground Surface	Water Table Elevation (feet)	Feet Below Ground Surface	Water Table Elevation (feet)	Feet Below Ground Surface	Water Table Elevation (feet)	Feet Below Ground Surface	Water Table Elevation (feet)	Feet Below Ground Surface	Water Table Elevation (feet)	Feet Below Ground Surface	Water Table Elevation (feet)	Feet Below Ground Surface	Water Table Elevation (feet)	Feet Below Ground Surface		
6/22	173	172.45	1.03	175.67	2.23	174.44	1.62	173.36	1.76	174.44	1.62	173.36	1.76	173.42	1.53	173.42	1.53				
6/23	174	172.29	1.19	174.87	3.03	174.14	1.92	172.87	2.25	174.14	1.92	172.87	2.25	173.12	1.83	173.12	1.83				
6/26	177	171.83	1.65	174.54	3.36	173.72	2.34	172.33	2.79	173.72	2.34	172.33	2.79	172.84	2.11	172.84	2.11				
6/27	178	171.73	1.75	174.51	3.39	173.60	2.46	172.21	2.91	173.60	2.46	172.21	2.91	172.79	2.16	172.79	2.16				
6/28	179	171.63	1.85	174.46	3.44	173.54	2.52	172.15	2.97	173.54	2.52	172.15	2.97	172.76	2.19	172.76	2.19				
6/29	180	171.63	1.85	174.44	3.46	173.47	2.59	172.06	3.06	173.47	2.59	172.06	3.06	172.69	2.26	172.69	2.26				
6/30	181	171.47	2.01	174.43	3.47	173.41	2.65	172.02	3.10	173.41	2.65	172.02	3.10	172.63	2.32	172.63	2.32				
7/5	186	171.15	2.33	174.36	3.54	173.16	2.90	171.85	3.27	173.16	2.90	171.85	3.27	172.45	2.50	172.45	2.50				
7/6	187	171.07	2.41	<174.29	>3.61	173.09	2.97	171.82	3.30	173.09	2.97	171.82	3.30	172.42	2.53	172.42	2.53				
7/7	188	171.06	2.42	<174.29	>3.61	173.05	3.01	171.79	3.33	173.05	3.01	171.79	3.33	172.35	2.60	172.35	2.60				
7/10	191	170.94	2.54	<174.29	>3.61	172.88	3.18	171.70	3.42	172.88	3.18	171.70	3.42	172.24	2.71	172.24	2.71				
7/11	192	170.94	2.54	<174.29	>3.61	172.83	3.23	171.69	3.43	172.83	3.23	171.69	3.43	172.20	2.75	172.20	2.75				
7/12	193	170.87	2.61	<174.29	>3.61	172.83	3.23	171.62	3.50	172.83	3.23	171.62	3.50	172.19	2.76	172.19	2.76				
7/13	194	170.84	2.64	<174.29	>3.61	172.77	3.29	171.56	3.56	172.77	3.29	171.56	3.56	172.04	2.91	172.04	2.91				
7/16	197	171.10	2.38	<174.29	>3.61	172.75	3.31	171.39	3.73	172.75	3.31	171.39	3.73	171.99	2.96	171.99	2.96				
7/26	207	171.89	1.59	<174.29	>3.61	172.31	3.75	171.11	4.01	172.31	3.75	171.11	4.01	171.71	3.24	171.71	3.24				
7/27	208	171.73	1.75	<174.29	>3.61	172.24	3.82	171.06	4.06	172.24	3.82	171.06	4.06	171.68	3.27	171.68	3.27				
8/2	213	171.17	2.13	<174.29	>3.61	171.58	4.47	171.03	4.09	171.58	4.47	171.03	4.09	171.48	3.47	171.48	3.47				
8/31	242	170.59	2.89	<174.29	>3.61	171.18	4.38	170.84	4.28	171.18	4.38	170.84	4.28	170.69	4.26	170.69	4.26				
9/7	249	170.04	3.44	<174.29	>3.61	<171.18	>4.38	<170.49	>4.63	<171.18	>4.38	<170.49	>4.63	170.29	4.66	170.29	4.66				
9/14	256	---	---	<174.29	>3.61	<171.18	>4.38	<170.49	>4.63	<171.18	>4.38	<170.49	>4.63	---	---	---	---				
9/21	263	170.19	3.29	<174.29	>3.61	<171.18	>4.38	<170.49	>4.63	<171.18	>4.38	<170.49	>4.63	170.44	4.51	170.44	4.51				
9/28	270	170.44	3.04	<174.29	>3.61	<171.18	>4.38	<170.49	>4.63	<171.18	>4.38	<170.49	>4.63	170.42	4.53	170.42	4.53				
10/5	277	170.34	3.14	<174.29	>3.61	<171.18	>4.38	<170.49	>4.63	<171.18	>4.38	<170.49	>4.63	170.59	4.36	170.59	4.36				
10/12	284	171.87	1.61	<174.29	>3.61	<171.18	>4.38	170.89	4.23	<171.18	>4.38	170.89	4.23	170.74	4.21	170.74	4.21				
10/26	297	170.99	2.49	<174.29	>3.61	<171.18	>4.38	170.77	4.35	<171.18	>4.38	170.77	4.35	170.74	4.21	170.74	4.21				
11/2	304	170.69	2.79	<174.29	>3.61	<171.18	>4.38	<170.74	>4.38	<171.18	>4.38	<170.74	>4.38	170.79	4.16	170.79	4.16				
11/8	311	170.59	2.89	<174.29	>3.61	<171.18	>4.38	<170.74	>4.38	<171.18	>4.38	<170.74	>4.38	170.74	4.21	170.74	4.21				
11/16	318	170.49	2.99	<174.29	>3.61	<171.18	>4.38	<170.74	>4.38	<171.18	>4.38	<170.74	>4.38	170.54	4.41	170.54	4.41				
11/22	324	170.44	3.04	<174.29	>3.61	<171.18	>4.38	<170.74	>4.38	<171.18	>4.38	<170.74	>4.38	170.54	4.41	170.54	4.41				
11/30	332	170.39	3.09	<174.29	>3.61	<171.18	>4.38	<170.74	>4.38	<171.18	>4.38	<170.74	>4.38	<170.51	>4.44	<170.51	>4.44				
12/14	346	171.39	2.09	<174.29	>3.61	172.03	4.03	172.04	3.08	172.03	4.03	172.04	3.08	170.44	4.51	170.44	4.51				
12/22	354	171.03	2.45	<174.29	>3.61	171.88	4.18	171.79	3.33	171.88	4.18	171.79	3.33	170.64	4.31	170.64	4.31				

APPENDIX B.
WATER TABLE ELEVATIONS - MINER INSTITUTE 1978
FIELD 31-1

		WATER TABLE PIPES														
		78-5			78-6			78-7			78-8			78-9		
Calendar Date	Julian Date	Water Table Elevation (feet)	Feet Below Ground Surface	Water Table Elevation (feet)	Feet Below Ground Surface	Water Table Elevation (feet)	Feet Below Ground Surface	Water Table Elevation (feet)	Feet Below Ground Surface	Water Table Elevation (feet)	Feet Below Ground Surface	Water Table Elevation (feet)	Feet Below Ground Surface	Water Table Elevation (feet)	Feet Below Ground Surface	
4/7	97	174.07	0.88	174.22	0.74	173.19	0.74	Ice	---	Ice	---	Ice	---	Ice	---	
4/9	99	174.00	0.95	173.94	1.02	173.11	0.82	Ice	---	Ice	---	Ice	---	Ice	---	
4/10	100	174.42	0.53	173.96	1.00	173.48	0.45	173.98	0.00	173.98	0.00	173.98	0.00	174.03	0.00	
4/11	101	174.95	0.00	174.96	0.00	173.74	0.19	173.98	0.00	173.98	0.00	173.98	0.00	174.03	0.00	
4/13	103	174.47	0.48	174.20	0.76	173.45	0.48	171.90	2.08	171.90	2.08	171.88	2.15	171.88	2.15	
4/19	109	173.00	1.95	172.22	2.74	172.05	1.88	172.78	1.20	172.78	1.20	173.26	0.77	173.26	0.77	
4/20	110	172.94	2.01	172.16	2.80	172.04	1.89	172.39	1.59	172.39	1.59	172.98	1.05	172.98	1.05	
4/21	111	172.77	2.18	172.27	2.69	172.08	1.85	172.20	1.78	172.20	1.78	172.63	1.40	172.63	1.40	
4/22	112	172.73	2.22	172.27	2.69	171.99	1.94	172.12	1.86	172.12	1.86	172.23	1.80	172.23	1.80	
4/23	113	172.71	2.24	172.21	2.75	171.99	1.94	172.03	1.95	172.03	1.95	171.98	2.05	171.98	2.05	
4/24	114	172.64	2.31	172.21	2.75	171.95	1.98	171.96	2.02	171.96	2.02	171.68	2.35	171.68	2.35	
4/25	115	172.55	2.40	172.11	2.85	171.88	2.05	171.84	2.09	171.84	2.09	171.45	2.58	171.45	2.58	
4/26	116	172.47	2.48	172.08	2.88	171.84	2.09	171.82	2.11	171.82	2.11	171.38	2.65	171.38	2.65	
4/27	117	172.43	2.52	172.02	2.94	171.82	2.11	171.58	2.40	171.58	2.40	171.27	2.76	171.27	2.76	
4/29	119	172.35	2.60	171.98	2.98	171.79	2.14	171.71	2.27	171.71	2.27	171.36	2.67	171.36	2.67	
5/11	131	172.06	2.89	171.99	2.97	171.56	2.37	171.51	2.42	171.51	2.42	171.18	2.85	171.18	2.85	
5/18	138	172.02	2.93	172.00	2.96	171.51	2.42	171.38	2.55	171.38	2.55	171.08	2.95	171.08	2.95	
5/25	145	171.92	3.03	171.90	3.06	171.38	2.55	171.52	2.41	171.52	2.41	171.46	2.61	171.46	2.61	
6/1	152	172.06	2.89	172.16	2.80	171.52	2.41	171.62	2.36	171.62	2.36	171.38	2.65	171.38	2.65	
6/6	157	172.04	2.91	172.01	2.95	171.50	2.43	171.60	2.38	171.60	2.38	171.32	2.71	171.32	2.71	
6/7	157	172.08	2.87	172.07	2.89	171.52	2.41	171.60	2.38	171.60	2.38	171.32	2.71	171.32	2.71	
6/8	158	172.19	2.87	172.07	2.89	171.52	2.41	171.60	2.38	171.60	2.38	171.32	2.71	171.32	2.71	
6/9	159	172.19	2.76	172.24	2.72	171.84	2.09	172.31	1.67	172.31	1.67	172.64	1.39	172.64	1.39	
6/12	163	172.19	2.76	172.29	2.67	171.85	2.08	172.24	1.74	172.24	1.74	172.34	1.69	172.34	1.69	
6/13	164-1	172.19	2.76	172.15	2.80	171.80	2.13	172.14	1.84	172.14	1.84	171.65	2.38	171.65	2.38	
6/13	164-2	172.19	2.76	172.13	2.83	171.77	2.16	172.06	1.92	172.06	1.92	171.53	2.50	171.53	2.50	
6/13	164-3	172.16	2.79	172.09	2.87	171.74	2.19	172.04	1.94	172.04	1.94	171.48	2.55	171.48	2.55	
6/14	165	172.18	2.77	172.09	2.87	171.75	2.18	172.06	1.92	172.06	1.92	171.52	2.51	171.52	2.51	
6/15	166	172.16	2.79	172.13	2.83	171.75	2.18	172.06	1.92	172.06	1.92	171.44	2.59	171.44	2.59	
6/16	167	172.14	2.81	172.09	2.87	171.75	2.18	172.01	1.97	172.01	1.97	171.32	2.71	171.32	2.71	
6/19	170	172.10	2.85	172.09	2.87	171.72	2.21	171.93	2.05	171.93	2.05	171.22	2.81	171.22	2.81	
6/21	172-1	173.10	1.85	172.06	2.90	171.70	2.22	171.78	2.20	171.78	2.20	172.27	2.76	172.27	2.76	
6/21	172-2	173.74	1.21	173.44	1.52	173.30	0.63	173.77	0.21	173.77	0.21	173.85	0.18	173.85	0.18	
6/21		173.74	1.21	173.44	1.52	173.03	0.89	173.82	0.16	173.82	0.16	173.85	0.18	173.85	0.18	

APPENDIX B.
 WATER TABLE ELEVATIONS - MINER INSTITUTE 1978
 FIELD 31-1

Calendar Date	Julian Date	78-5				78-6				78-7				78-8				78-9			
		Water Table Elevation (feet)	Feet Below Ground Surface	Water Table Elevation (feet)	Feet Below Ground Surface	Water Table Elevation (feet)	Feet Below Ground Surface	Water Table Elevation (feet)	Feet Below Ground Surface	Water Table Elevation (feet)	Feet Below Ground Surface	Water Table Elevation (feet)	Feet Below Ground Surface	Water Table Elevation (feet)	Feet Below Ground Surface	Water Table Elevation (feet)	Feet Below Ground Surface	Water Table Elevation (feet)	Feet Below Ground Surface		
6/22	173	173.24	1.71	173.04	1.92	172.38	1.55	173.60	0.36	173.81	0.22										
6/23	174	173.14	1.81	172.65	2.31	172.25	1.68	172.95	1.03	173.12	0.91										
6/26	177	172.55	2.40	172.19	2.77	172.00	1.93	172.47	1.51	171.89	2.14										
6/27	178	172.51	2.44	172.19	2.77	171.95	1.98	172.37	1.61	171.68	2.35										
6/28	179	172.44	2.51	172.15	2.80	171.92	2.01	172.27	1.71	171.50	2.53										
6/29	180	172.39	2.56	172.11	2.85	171.89	2.04	172.19	1.79	171.39	2.64										
6/30	181	172.34	2.61	172.09	2.87	171.84	2.09	172.11	1.87	171.30	2.73										
7/5	186	172.18	2.77	171.94	3.02	171.70	2.22	171.73	2.25	170.94	3.09										
7/6	187	172.13	2.82	171.93	3.03	171.69	2.23	171.68	2.30	170.88	3.15										
7/7	188	172.10	2.85	171.88	3.08	171.66	2.27	171.62	2.36	170.88	3.15										
7/10	191	172.00	2.95	171.81	3.15	171.57	2.36	171.44	2.54	170.71	3.32										
7/11	192	171.96	2.99	171.76	3.20	171.53	2.40	171.24	2.74	170.66	3.36										
7/12	193	171.90	3.05	171.68	3.28	171.41	2.52	171.09	2.89	170.60	3.43										
7/13	194	171.83	3.12	171.61	3.34	171.36	2.57	170.90	3.08	170.50	3.53										
7/16	197	171.75	3.20	171.42	3.54	171.23	2.70	170.50	3.48	170.22	3.81										
7/26	207	171.60	3.35	171.17	3.79	171.15	2.78	171.06	2.92	<170.02	>4.01										
7/27	208	171.50	3.45	171.12	3.84	171.10	2.83	170.83	3.15	<170.02	>4.01										
8/2	213	171.21	3.74	170.97	3.98	170.82	3.11	<170.37	>3.61	<170.02	>4.01										
8/31	242	170.94	4.01	170.77	4.19	169.76	4.17	170.46	3.52	170.03	4.00										
9/7	249	170.69	4.26	170.62	4.34	<169.66	>4.27	<170.37	>3.61	<170.02	>4.01										
9/14	256	-----	-----	-----	-----	<169.66	>4.27	<170.37	>3.61	<170.02	>4.01										
9/21	263	170.64	4.31	170.67	4.29	<169.66	>4.27	<170.37	>3.61	<170.02	>4.01										
9/28	270	170.74	4.21	170.72	4.24	<169.66	>4.27	<170.37	>3.61	<170.02	>4.01										
10/5	277	170.64	4.31	<170.62	>4.34	<169.66	>4.27	<170.37	>3.61	<170.02	>4.01										
10/12	284	170.70	4.25	170.83	4.13	<169.66	>4.27	170.76	3.22	<170.02	>4.01										
10/26	297	<170.64	>4.31	170.72	4.24	<169.66	>4.27	<170.37	>3.61	<170.02	>4.01										
11/2	304	<170.64	>4.31	170.72	4.24	<169.66	>4.27	<170.37	>3.61	<170.02	>4.01										
11/8	311	<170.64	>4.31	170.72	4.24	<169.66	>4.27	<170.37	>3.61	<170.02	>4.01										
11/16	318	<170.64	>4.31	170.67	4.29	<169.66	>4.27	<170.37	>3.61	<170.02	>4.01										
11/22	324	<170.64	>4.31	170.62	4.34	<169.66	>4.27	<170.37	>3.61	<170.02	>4.01										
11/30	332	<170.64	>4.31	<170.62	>4.34	<169.66	>4.27	<170.37	>3.61	<170.02	>4.01										
12/14	346	172.09	2.86	172.07	2.89	171.41	2.52	170.96	3.02	171.13	2.90										
12/22	354	171.94	3.01	172.67	2.29	171.31	2.62	170.92	3.06	170.72	3.31										

APPENDIX B.

WATER TABLE ELEVATIONS - MINER INSTITUTE 1978
FIELD 31-1

Calendar Date	Julian Date	WATER TABLE PIPES					
		78-10		78-11		78-12	
		Water Table Elevation (feet)	Feet Below Ground Surface	Water Table Elevation (feet)	Feet Below Ground Surface	Water Table Elevation (feet)	Feet Below Ground Surface
4/7	97	Ice	-----	173.57	0.80	Ice	-----
4/9	99	173.48	0.51	172.56	1.81	Ice	-----
4/10	100	173.99	0.00	172.98	1.39	173.70	0.85
4/11	101	173.99	0.00	173.37	1.00	173.79	0.76
4/13	103	173.99	0.00	172.55	1.82	173.40	1.15
4/19	109	171.51	2.48	171.37	3.00	171.75	2.80
4/20	110	173.08	0.91	171.56	2.81	172.86	1.69
4/21	111	172.66	1.33	171.78	2.59	172.75	1.80
4/22	112	172.22	1.77	171.72	2.65	172.50	2.05
4/23	113	171.84	2.15	171.57	2.80	172.22	2.33
4/24	114	171.61	2.38	171.42	2.95	172.05	2.50
4/25	115	171.39	2.60	171.31	3.06	171.95	2.60
4/26	116	171.24	2.75	171.18	3.19	171.76	2.79
4/27	117	171.18	2.81	171.14	3.23	171.69	2.86
4/29	119	171.10	2.89	171.07	3.30	171.61	2.94
5/11	131	171.34	2.65	171.54	2.83	171.74	2.81
5/18	138	171.38	2.61	171.46	2.91	171.64	2.91
5/25	145	171.28	2.71	171.49	2.88	171.53	3.02
6/1	152	171.69	2.30	171.55	2.82	171.59	2.96
6/6	157	171.44	2.55	171.59	2.78	171.61	2.94
6/7	158	171.40	2.59	171.58	2.79	171.60	2.95
6/8	159	172.48	1.51	171.73	2.64	171.80	2.75
6/9	160	172.22	1.77	171.83	2.54	171.84	2.71
6/12	163	171.63	2.36	171.67	2.70	171.79	2.76
6/13	164-1	171.54	2.44	171.65	2.72	171.76	2.79
6/13	164-2	171.50	2.49	171.60	2.77	171.70	2.84
6/13	164-3	171.60	2.39	171.60	2.77	171.70	2.84
6/14	165	171.53	2.46	171.60	2.77	171.72	2.83
6/15	166	171.46	2.53	171.59	2.78	171.69	2.86
6/16	167	171.36	2.62	171.56	2.81	171.64	2.90
6/19	170	171.46	2.53	171.49	2.88	171.51	3.04
6/21	172-1	173.89	0.10	172.26	2.11	173.81	0.74
6/21	172-2	173.86	0.13	172.97	1.40	173.79	0.76

APPENDIX C.

WATER TABLE ELEVATIONS - MINER INSTITUTE 1978
FIELD 3I-1

Calendar Date	Julian Date	WATER TABLE PIPES					
		78-10		78-11		78-12	
		Water Table Elevation (feet)	Feet Below Ground Surface	Water Table Elevation (feet)	Feet Below Ground Surface	Water Table Elevation (feet)	Feet Below Ground Surface
6/22	173	173.60	0.39	172.62	1.75	173.33	1.22
6/23	174	172.92	1.07	172.39	1.97	172.90	1.65
6/26	177	171.86	2.13	171.91	2.45	172.28	2.27
6/27	178	171.73	2.26	171.82	2.55	172.17	2.38
6/28	179	171.60	2.39	171.74	2.63	172.05	2.50
6/29	180	171.48	2.51	171.64	2.73	171.92	2.63
6/30	181	171.41	2.57	171.57	2.80	171.84	2.71
7/5	186	171.09	2.90	171.34	3.03	171.43	3.12
7/6	187	171.02	2.97	171.28	3.09	171.38	3.17
7/7	188	170.97	3.01	171.19	3.18	171.33	3.22
7/10	191	170.77	3.21	171.00	3.37	171.08	3.46
7/11	192	170.69	3.99	170.98	3.39	171.00	3.55
7/12	193	170.59	3.40	170.96	3.41	170.93	3.61
7/13	194	170.52	3.46	170.95	3.42	<170.80	>3.74
7/16	197	170.28	3.71	170.93	3.44	<170.80	>3.74
7/26	207	<170.22	>3.77	170.95	3.42	<170.80	>3.74
7/27	208	<170.22	>3.77	170.93	3.44	<170.80	>3.74
8/2	213	<170.22	>3.77	<170.64	>3.73	<170.80	>3.74
8/31	242	170.19	3.80	170.74	3.63	170.71	3.84
9/7	249	<170.22	>3.77	<170.64	>3.73	<170.71	>3.84
9/14	256	<170.22	>3.77	<170.64	>3.73	<170.71	>3.84
9/21	263	<170.22	>3.77	<170.64	>3.73	<170.71	>3.84
9/28	270	<170.22	>3.77	<170.64	>3.73	<170.71	>3.84
10/5	277	<170.22	>3.77	<170.64	>3.73	<170.71	>3.84
10/12	284	<170.22	>3.77	170.64	3.73	171.20	3.35
10/26	297	<170.22	>3.77	<170.64	>3.73	170.93	3.62
11/2	304	<170.22	>3.77	<170.64	>3.73	<170.71	>3.84
11/8	311	<170.22	>3.77	<170.64	>3.73	<170.71	>3.84
11/16	318	<170.22	>3.77	<170.64	>3.73	<170.71	>3.84
11/22	324	<170.22	>3.77	<170.64	>3.73	<170.71	>3.84
11/30	332	<170.22	>3.77	<170.64	>3.73	<170.71	>3.84
12/14	346	171.04	2.95	171.29	3.08	171.04	3.51
12/22	354	170.84	3.15	171.07	3.30	170.93	3.62

APPENDIX C.

WATER TABLE ELEVATIONS - MINER INSTITUTE - 1978

FIELD - LAKE ALICE

Calendar Date	Julian Date	WATER TABLE PIPES					
		LAWT-1		LAWT-2		LAWT-3	
		Water Table Elevation (feet)	Feet Below Ground Surface	Water Table Elevation (feet)	Feet Below Ground Surface	Water Table Elevation (feet)	Feet Below Ground Surface
4/7	97	361.10	0.00	>361.72	<0.00	>361.93	<0.00
4/13	103	>361.10	<0.00	>361.72	<0.00	361.54	0.39
4/20	110	360.98	0.12	>361.72	<0.00	361.54	0.39
4/27	117	360.18	0.92	360.78	0.94	360.90	1.03
5/4	124	359.47	1.63	360.26	1.46	360.44	1.49
5/11	131	359.46	1.64	360.28	1.44	360.53	1.40
5/18	138	360.10	1.00	360.91	0.81	361.00	0.93
5/25	145	358.80	2.30	359.69	2.03	359.94	1.99
6/1	152	360.51	0.59	361.45	0.27	361.38	0.55
6/6	157	359.67	1.43	360.47	1.25	360.79	1.14
6/7	158	359.42	1.68	360.24	1.48	360.58	1.35
6/8	159	360.65	0.45	361.38	0.34	361.44	0.49
6/9	160	360.09	1.01	360.92	0.80	361.04	0.89
6/12	163	359.17	1.93	360.06	1.66	360.38	1.55
6/13	164	358.97	2.13	359.96	1.76	360.32	1.61
6/13	164	359.66	1.44	360.88	0.84	361.30	0.63
6/14	165	360.10	1.05	360.95	0.77	361.17	0.76
6/15	166	359.56	1.54	360.44	1.28	360.68	1.25
6/16	167	359.20	1.90	360.08	1.64	360.35	1.58
6/19	170	359.27	1.83	360.21	1.51	360.51	1.42
6/20	171	361.01	0.09	361.72	0.00	361.76	0.17
6/20	171	361.01	0.09	361.72	0.00	361.69	0.24
6/21	172	360.89	0.21	361.72	0.00	361.40	0.53
6/22	173	360.81	0.29	361.47	0.25	361.36	0.56
6/23	174	360.22	0.88	360.98	0.74	360.97	0.96
6/26	177	359.23	1.87	360.13	1.59	360.35	1.58
6/27	178	359.10	2.00	359.96	1.76	360.22	1.71
6/28	179	359.02	2.08	359.93	1.79	360.15	1.78

Note: the greater than (>) and lesser than (<) symbols indicate the upper and lower boundaries of the water table measurement pipe.

APPENDIX

WATER TABLE ELEVATIONS - MINER INSTITUTE - 1978

FIELD - LAKE ALICE

Calendar Date	Julian Date	WATER TABLE PIPES					
		LAWT-1		LAWT-2		LAWT-3	
		Water Table Elevation (feet)	Feet Below Ground Surface	Water Table Elevation (feet)	Feet Below Ground Surface	Water Table Elevation (feet)	Feet Below Ground Surface
6/29	180	358.82	2.28	359.67	2.05	359.91	2.02
6/30	181	358.68	2.42	359.49	2.23	359.69	2.24
7/5	186	<358.47	>2.62	359.03	2.69	359.46	2.47
7/6	187	<358.47	>2.62	359.03	2.69	359.45	2.48
7/7	188	<358.47	>2.62	<358.88	>2.84	<359.36	>2.57
7/10	191	<358.47	>2.62	<358.88	>2.84	<359.36	>2.57
7/11	192	<358.47	>2.62	<358.88	>2.84	<359.36	>2.57
7/12	193	<358.47	>2.62	<358.88	>2.84	<359.36	>2.57
7/16	197	<358.47	>2.62	<358.88	>2.84	<359.36	>2.57
7/26	207	<358.47	>2.62	<358.88	>2.84	<359.36	>2.57
7/27	208	<358.47	>2.62	<358.88	>2.84	<359.36	>2.57
8/2	213	<358.47	>2.62	<358.88	>2.84	<359.36	>2.57
8/9	220	<358.47	>2.62	<358.88	>2.84	<359.36	>2.57
8/31	242	<358.47	>2.62	358.88	2.84	359.36	2.57
9/7	249	<358.47	>2.62	<358.88	>2.84	<359.36	>2.57
9/14	256	<358.47	>2.62	<358.88	>2.84	<359.36	>2.57
9/28	270	<358.47	>2.62	<358.88	>2.84	<359.36	>2.57
10/5	277	<358.47	>2.62	<358.88	>2.84	<359.36	>2.57
10/12	284	<358.47	>2.62	<358.88	>2.84	<359.36	>2.57
10/19	291	<358.47	>2.62	<358.88	>2.84	<359.36	>2.57
10/26	297	<358.47	>2.62	<358.88	>2.84	<359.36	>2.57
11/2	304	<358.47	>2.62	<358.88	>2.84	<359.36	>2.57
11/8	311	<358.47	>2.62	<358.88	>2.84	<359.36	>2.57
11/16	318	<358.47	>2.62	<358.88	>2.84	<359.36	>2.57
11/22	324	<358.47	>2.62	<358.88	>2.84	<359.36	>2.57
11/30	332	<358.47	>2.62	<358.88	>2.84	<359.36	>2.57
12/14	346	359.06	2.04	359.63	2.09	359.93	2.00
12/22	354	358.66	2.44	359.33	2.39	359.78	2.15

APPENDIX

WATER TABLE ELEVATIONS - MINER INSTITUTE - 1978

FIELD - LAKE ALICE

Calendar Date	Julian Date	WATER TABLE PIPES					
		LAWT-4		LAWT-5		LAWT-6	
		Water Table Elevation (feet),	Feet Below Ground Surface	Water Table Elevation (feet)	Feet Below Ground Surface	Water Table Elevation (feet)	Feet Below Ground Surface
4/7	97	Ice	-----	>362.19	<0.00	Ice	-----
4/13	103	>361.81	<0.00	362.06	0.13	>361.08	<0.00
4/20	110	361.67	0.14	361.96	0.23	>361.08	<0.00
4/27	117	361.28	0.53	361.67	0.52	360.85	0.23
5/4	124	361.05	0.76	361.44	0.75	360.48	0.60
5/11	131	360.91	0.90	361.44	0.75	360.53	0.55
5/18	138	361.45	0.36	361.83	0.36	360.79	0.29
5/25	145	360.55	1.26	361.00	1.19	359.93	1.15
6/1	152	361.71	0.10	361.96	0.23	360.97	0.11
6/6	137	360.18	1.63	361.56	0.63	360.73	0.35
6/7	158	360.95	0.86	361.40	0.79	360.61	0.47
6/8	159	361.63	0.18	362.03	0.16	360.98	0.10
6/9	160	361.45	0.36	361.76	0.43	360.88	0.20
6/12	163	360.72	1.09	361.23	0.96	360.42	0.66
6/13	164	360.67	1.14	361.14	1.05	360.32	0.76
6/13	164	361.56	0.25	362.05	0.14	360.93	0.15
6/14	165	361.40	0.41	361.89	0.30	360.88	0.20
6/15	166	361.04	0.77	361.53	0.66	360.70	0.38
6/16	167	360.64	1.17	361.23	0.96	360.36	0.72
6/19	170	360.92	0.89	361.59	0.60	360.59	0.49
6/20	171	361.81	0.00	362.19	0.00	361.08	0.00
6/20	171	361.81	0.00	362.07	0.12	361.08	0.00
6/21	172	361.65	0.15	361.96	0.23	360.96	0.12
6/22	173	361.63	0.18	361.96	0.23	360.98	0.10
6/23	174	361.42	0.38	361.70	0.48	360.88	0.20
6/26	177	360.71	1.10	361.20	0.99	360.42	0.66
6/27	178	360.61	1.20	361.14	1.05	360.21	0.87
6/28	179	360.53	1.28	361.11	1.07	360.06	1.02

APPENDIX

WATER TABLE ELEVATIONS - MINER INSTITUTE - 1978

FIELD - LAKE ALICE

Calendar Date	Julian Date	WATER TABLE PIPES					
		LAWT-4		LAWT-5		LAWT-6	
		Water Table Elevation (feet)	Feet Below Ground Surface	Water Table Elevation (feet)	Feet Below Ground Surface	Water Table Elevation (feet)	Feet Below Ground Surface
6/29	180	360.25	1.56	360.86	1.33	359.60	1.48
6/30	181	360.07	1.74	360.77	1.42	359.29	1.79
7/5	186	<359.46	>2.35	360.41	1.78	<358.75	>2.33
7/6	187	<359.46	>2.35	360.41	1.78	<358.75	>2.33
7/7	188	<359.46	>2.35	360.38	1.81	<358.75	>2.33
7/10	191	<359.46	>2.35	360.30	1.89	<358.75	>2.33
7/11	192	<359.46	>2.35	360.28	1.91	<358.75	>2.33
7/12	193	<359.46	>2.35	360.25	1.94	<358.75	>2.33
7/16	197	<359.46	>2.35	360.17	2.02	<358.75	>2.33
7/26	207	<359.46	>2.35	360.09	2.10	<358.75	>2.33
7/27	208	<359.46	>2.35	360.05	2.14	<358.75	>2.33
8/2	213	<359.46	>2.35	359.94	2.25	<358.75	>2.33
8/9	220	<359.46	>2.35	359.82	2.37	<358.75	>2.33
8/31	242	359.46	2.35	359.79	2.40	<358.75	>2.33
9/7	249	<359.46	>2.35	359.69	2.50	<358.75	>2.33
9/14	256	<359.46	>2.35	359.68	2.51	<358.75	>2.33
9/28	270	<359.46	>2.35	<359.68	>2.51	<358.75	>2.33
10/5	277	<359.46	>2.35	<359.68	>2.51	<358.75	>2.33
10/12	284	<359.46	>2.35	<359.68	>2.51	<358.75	>2.33
10/19	291	<359.46	>2.35	<359.68	>2.51	<358.75	>2.33
10/26	297	<359.46	>2.35	<359.68	>2.51	<358.75	>2.33
11/2	304	<359.46	>2.35	<359.68	>2.51	<358.75	>2.33
11/8	311	<359.46	>2.35	<359.68	>2.51	<358.75	>2.33
11/16	318	<359.46	>2.35	<359.68	>2.51	<358.75	>2.33
11/22	324	<359.46	>2.35	<359.68	>2.51	<358.75	>2.33
11/30	332	<359.46	>2.35	<359.68	>2.51	<358.75	>2.33
12/14	346	360.11	1.70	361.29	0.90	359.92	1.16
12/22	354	359.91	1.90	360.64	1.55	359.42	1.66

APPENDIX

WATER TABLE ELEVATIONS - MINER INSTITUTE 1978

FIELD 3I-2

Calendar Date	Julian Date	WATER TABLE PIPES					
		1		2		3	
		Water Table Elevation (feet)	Feet Below Ground Surface	Water Table Elevation (feet)	Feet Below Ground Surface	Water Table Elevation (feet)	Feet Below Ground Surface
4/7	97	182.38	0.04	> 182.30	< 0.00	Ice	-----
4/13	103	181.78	0.64	181.80	0.50	170.36	1.61
4/20	110	181.24	1.18	180.92	1.38	170.08	1.89
4/27	117	< 180.63	> 1.79	< 179.90	> 2.40	169.76	2.21
5/4	124	< 180.63	> 1.79	< 179.90	> 2.40	169.46	2.51
5/11	131	< 180.63	> 1.79	< 179.90	> 2.40	169.86	2.11
5/18	138	< 180.63	> 1.79	< 179.90	> 2.40	169.80	2.17
5/25	145	< 180.63	> 1.79	< 179.90	> 2.40	169.72	2.25
6/1	152	< 180.63	> 1.79	< 179.90	> 2.40	169.98	1.99
6/6	157	< 180.63	> 1.79	< 179.90	> 2.40	169.95	2.02
6/7	158	< 180.63	> 1.79	< 179.90	> 2.40	169.92	2.05
6/8	159	< 180.63	> 1.79	< 179.90	> 2.40	170.05	1.92
6/9	160	< 180.63	> 1.79	< 179.90	> 2.40	170.03	1.94
6/12	163	< 180.63	> 1.79	< 179.90	> 2.40	169.87	2.10
6/13-1	164-1	< 180.63	> 1.79	< 179.90	> 2.40	169.85	2.12
6/13-2	164-2	< 180.63	> 1.79	< 179.90	> 2.40	169.87	2.10
6/13-3	164-3	< 180.63	> 1.79	< 179.90	> 2.40	169.90	2.07
6/14	165	< 180.63	> 1.79	< 179.90	> 2.40	169.90	2.07
6/15	166	< 180.63	> 1.79	< 179.90	> 2.40	169.87	2.10
6/16	167	< 180.63	> 1.79	< 179.90	> 2.40	169.87	2.10
6/19	170	< 180.63	> 1.70	< 179.90	> 2.40	170.10	1.87
6/20	171	< 180.63	> 1.79	< 179.90	> 2.40	170.10	1.87
6/22	173	< 180.63	> 1.79	< 179.90	> 2.40	170.08	1.89
6/23	174	< 180.63	> 1.79	< 179.90	> 2.40	170.03	1.94
6/26	177	< 180.63	> 1.79	< 179.90	> 2.40	169.90	2.07

APPENDIX D.

WATER TABLE ELEVATIONS - MINER INSTITUTE 1978

FIELD 3I-2

Calendar Date	Julian Date	WATER TABLE PIPES					
		1		2		3	
		Water Table Elevation (feet)	Feet Below Ground Surface	Water Table Elevation (feet)	Feet Below Ground Surface	Water Table Elevation (feet)	Feet Below Ground Surface
6/27	178	<180.63	>1.79	<179.90	>2.40	169.87	2.10
6/28	179	<180.63	>1.79	<179.90	>2.40	169.77	2.20
6/29	180	<180.63	>1.79	<179.90	>2.40	169.69	2.28
6/30	181	<180.63	>1.79	<179.90	>2.40	169.49	2.48
7/5	186	<180.63	>1.79	<179.90	>2.40	<169.36	>2.61
8/31	242	<180.63	>1.79	<179.90	>2.40	<169.36	>2.61
9/7	249	<180.63	>1.79	<179.90	>2.40	<169.36	>2.61
9/14	256	<180.63	>1.79	<179.90	>2.40	<169.36	>2.61
9/28	270	<180.63	>1.79	<179.90	>2.40	<169.36	>2.61
10/5	277	<180.63	>1.79	<179.90	>2.40	<169.36	>2.61
10/12	284	<180.63	>1.79	<179.90	>2.40	<169.36	>2.61
10/19	291	<180.63	>1.79	<179.90	>2.40	<169.36	>2.61
10/26	297	<180.63	>1.79	<179.90	>2.40	<169.36	>2.61
11/2	304	<180.63	>1.79	<179.90	>2.40	<169.36	>2.61
11/8	311	<180.63	>1.79	<179.90	>2.40	<169.36	>2.61
11/16	318	<180.63	>1.79	<179.90	>2.40	<169.36	>2.61
11/22	324	<180.63	>1.79	<179.90	>2.40	<169.36	>2.61
11/30	332	<180.63	>1.79	<179.90	>2.40	<169.36	>2.61
12/6	338	<180.63	>1.79	<179.90	>2.40	<169.36	>2.61
12/14	346	<180.63	>1.79	<179.90	>2.40	169.71	2.26
12/22	354	<180.63	>1.79	<179.90	>2.40	<169.36	2.61

APPENDIX E.

WATER TABLE ELEVATIONS - MINER INSTITUTE 1978

FIELD 3I-4

Calendar Date	Julian Date	WATER TABLE PIPES					
		3oW		0		3oE	
		Water Table Elevation (feet)	Feet Below Ground Surface	Water Table Elevation (feet)	Feet Below Ground Surface	Water Table Elevation (feet)	Feet Below Ground Surface
4/7	97	>183.57	<0.00	183.49	-0.03	182.88	0.38
4/13	103	>183.57	<0.00	183.40	0.06	182.76	0.50
4/20	110	183.31	0.26	183.27	0.19	182.66	0.60
4/27	117	181.40	0.84	182.70	0.76	182.48	1.78
5/4	124	<181.40	2.17	182.17	1.29	182.03	1.23
5/11	131	<181.40	>2.17	182.20	1.26	<181.00	>2.26
5/18	138	<181.40	>2.17	<181.52	>1.94	<181.00	>2.26
5/25	145	<181.40	>2.17	<181.52	>1.94	<181.00	>2.26
6/1	152	<181.40	>2.17	<181.52	>1.94	<181.00	>2.26
6/6	157	<181.40	>2.17	<181.52	>1.94	<181.00	>2.26
6/7	158	<181.40	>2.17	<181.52	>1.94	<181.00	>2.26
6/8	159	<181.40	>2.17	<181.52	>1.94	<181.00	>2.26
6/9	160	<181.40	>2.17	<181.52	>1.94	<181.00	>2.26
8/31	242	<181.40	>2.17	<181.52	>1.94	<181.00	>2.26
9/7	249	<181.40	>2.17	<181.52	>1.94	<181.00	>2.26
9/14	256	<181.40	>2.17	<181.52	>1.94	<181.00	>2.26
9/21	263	<181.40	>2.17	<181.52	>1.94	<181.00	>2.26
9/28	270	<181.40	>2.17	<181.52	>1.94	<181.00	>2.26
10/5	277	<181.40	>2.17	<181.52	>1.94	<181.00	>2.26
10/12	284	<181.40	>2.17	<181.52	>1.94	<181.00	>2.26
10/26	297	<181.40	>2.17	<181.52	>1.94	<181.00	>2.26
11/2	304	<181.40	>2.17	<181.52	>1.94	<181.00	>2.26
11/8	311	<181.40	>2.17	<181.52	>1.94	<181.00	>2.26
11/16	318	<181.40	>2.17	<181.52	>1.94	<181.00	>2.26
11/22	324	<181.40	>2.17	<181.52	>1.94	<181.00	>2.26
11/30	332	<181.40	>2.17	<181.52	>1.94	<181.00	>2.26
12/14	346	<181.40	>2.17	<181.52	>1.94	<181.00	>2.26
12/22	354	<181.40	>2.17	<181.52	>1.94	<181.00	>2.26

APPENDIX F.

TILE OUTFLOWS - MINER INSTITUTE - 1978

FIELD 3I-1

Calendar Date	Julian Date				
		#3 (gpm)	#6 (gpm)	#9 (gpm)	#12 (gpm)
6/7	158	0.16	0.47	0.16	0.12
6/8	159	0.54	1.51	0.65	0.76
6/9	160	0.36	1.02	0.41	0.44
6/12	163	0.25	0.62	0.22	0.23
6/13-1	164	0.21	0.55	0.21	0.23
6/13-2	164	0.21	0.58	0.22	0.24
6/13-3	164	0.19	0.61	0.22	0.21
6/14	165	----	0.55	0.18	0.18
6/15	166	0.20	0.49	0.16	0.20
6/16	167	0.15	0.43	0.13	0.15
6/19	170	0.11	0.41	0.14	0.13
6/20	171	----	5.28	3.17	3.17
6/21	172	1.98	4.53	1.98	2.88
6/22	173	----	2.64	0.88	1.87
6/23	174	0.91	1.76	0.51	1.22
6/26	177	0.36	0.79	0.25	0.56
6/27	178	0.28	0.93	0.21	----
6/28	179	0.22	0.57	0.18	0.35
6/29	180	0.17	0.53	0.16	0.32
6/30	181	0.11	0.47	0.12	0.25
7/5	186	NF	0.18	0.02	0.08
7/6	187	NF	0.14	NF	0.06
7/7	188	NF	0.13	NF	0.03
7/10	191	NF	0.04	NF	NF
7/11	192	NF	NF	NF	NF
8/31	242	NF	NF	NF	NF
9/7	249	NF	NF	NF	NF
9/14	256	NF	NF	NF	NF
9/21	263	NF	NF	NF	NF
9/28	270	NF	NF	NF	NF
10/5	277	NF	NF	NF	NF
10/12	284	NF	NF	NF	NF
10/27	298	NF	NF	NF	NF
11/2	304	NF	NF	NF	NF
11/11	313	NF	NF	NF	NF
11/16	318	NF	NF	NF	NF
11/22	324	NF	NF	NF	NF
11/30	332	NF	NF	NF	NF
12/14	346	NF	0.32	NF	NF
12/22	354	SB	SB	SB	SB

Note: NF is no measureable flow
 SB is snowbound outlets